

CLK 320

CLK 500

CLK 55 AMG

Our company and staff congratulate you on the purchase of your new Mercedes-Benz.

Your selection of our product is a demonstration of your trust in our company name. Furthermore, it exemplifies your desire to own an automobile that will be as easy as possible to operate and provide years of service.

Your Mercedes-Benz represents the efforts of many skilled engineers and craftsmen. To help assure your driving pleasure, and also the safety of you and your passengers, we ask you to make a small investment of time:

- Please read this manual carefully, then return it to your vehicle where it will be handy for your reference.
- Please follow the recommendations contained in this manual. They are designed to acquaint you with the operation of your Mercedes-Benz.
- Please pay attention to the warnings and cautions contained in this manual. They are designed to help improve the safety of the vehicle operator and occupants.

We extend our best wishes for many miles of safe, pleasurable driving.

Mercedes-Benz USA, LLC
A DaimlerChrysler Company

Contents

Introduction	9	At a glance	19	Getting started	29
Product information	9	Cockpit	20	Unlocking	30
Operator's Manual	10	Instrument cluster	22	Unlocking with the SmartKey	30
Service and warranty information ..	10	Multifunction steering wheel	24	Unlocking with KEYLESS-GO*	32
Important notice for California		Center console	25	Adjusting	34
retail buyers and lessees of		Upper part	25	Seats	34
Mercedes-Benz automobiles	11	Lower part	26	Steering wheel	37
Maintenance	12	Overhead control panel	27	Mirrors	38
Roadside Assistance	12	Door control panel	28	Driving	40
Change of address or ownership ...	12			Fastening the seat belts	40
Operating your vehicle				Starting the engine	43
outside the USA or Canada	13			Switching on headlamps	47
Where to find it	14			Turn signals and high beam	48
Symbols	15			Windshield wipers	48
Operating safety	16			Problems while driving	50
Proper use of the vehicle	16			Parking and locking	51
Problems with your vehicle	17			Parking brake	52
Reporting safety defects	18			Switching off headlamps	53
Reporting safety defects	18			Turning off the engine	53

Contents

Safety and Security	57	Controls in detail	85	Memory function	116
Occupant safety.....	58	Locking and unlocking.....	86	Storing positions into memory.....	117
Airbags.....	59	SmartKeys.....	86	Recalling positions from memory.	117
Seat belts.....	64	SmartKey with KEYLESS-GO*	89	Storing exterior rear view	
Children in the vehicle.....	68	Opening the doors		mirror parking position	118
Blocking of rear side		from the inside.....	95	Lighting	119
window operation.....	74	Opening the trunk	96	Exterior lamp switch	119
Panic alarm.....	75	Closing the trunk.....	97	Combination switch	123
Activating	75	Trunk lid		Hazard warning flasher	123
Deactivating	75	opening/closing system*	98	Interior lighting	124
Driving safety systems.....	76	Trunk lid emergency release	103	Door entry lamps	125
ABS	76	Separately locking the trunk	104	Instrument cluster	126
BAS	77	Separately unlocking the trunk	105	Instrument cluster illumination	126
ESP.....	78	Automatic central locking	105	Coolant temperature indicator.....	127
Anti-theft systems.....	81	Locking and unlocking		Trip odometer	127
Immobilizer.....	81	from the inside	106	Tachometer.....	128
Anti-theft alarm system	82	Seats	107	Outside temperature indicator.....	128
Tow-away alarm	83	Easy-entry/exit feature	107		
		Removing and installing			
		front seat head restraints.....	108		
		Rear seats head restraints	109		
		Multicontour seat*	112		
		Seat ventilation*	113		
		Seat heating*	114		

Contents

Control system	129	Good visibility	166	Audio system.....	183
Multifunction display.....	129	Windshield wipers.....	166	Audio and telephone, operation....	183
Multifunction steering wheel.....	130	Headlamp cleaning system*	166	Operating safety	183
Menus	132	Rear view mirror	167	Operating and display elements ...	184
Standard display menu	134	Sun visors	169	Button and soft key operation	186
AUDIO menu	134	Rear window sunshade*	170	Operation.....	186
NAV menu.....	137	Rear window defroster.....	171	Radio operation	189
Distronic* menu.....	137	Automatic climate control	172	Satellite radio (SAT)* (USA only)...	192
Malfunction memory menu	138	Setting the temperature.....	175	Cassette operation	196
Settings menu	139	Adjusting air distribution.....	176	CD changer* operation.....	199
Trip computer menu.....	152	Adjusting air volume	177	Telephone* operation.....	203
TEL menu*	154	Maximum cooling MAXCOOL.....	177	Power windows	210
Automatic transmission.....	157	Defrosting	177	Opening and	
One-touch gearshifting.....	158	Air recirculation mode	178	closing the windows	210
Gear ranges	159	Charcoal filter	179	Synchronizing power windows.....	213
Gear selector lever position	160	Deactivating the		Sliding/pop-up roof*	214
Steering wheel gearshift control		climate control system	180	Opening and closing	
(Speedshift) CLK 55 AMG	161	Air conditioning.....	181	the sliding/pop-up roof	214
Program mode selector switch.....	163	Residual heat and ventilation*	181	Synchronizing the	
Accelerator position.....	163	Rear passenger compartment		sliding / pop-up roof.....	217
Manual shift program		adjustable air vents.....	182	Driving systems.....	218
CLK 55 AMG	164			Cruise control	218
Emergency operation				Distronic*	221
(Limp Home Mode)	165			Parktronic (Parking assist)*	233

Contents

Loading.....	237				
Roof rack.....	237				
Ski sack*.....	237				
Split rear bench seat.....	240				
Loading instructions.....	242				
Cargo tie-down rings.....	243				
Useful features.....	244				
Interior storage spaces.....	244				
Ashtrays.....	247				
Cigarette lighter.....	248				
Floormats*.....	249				
Telephone*.....	250				
Tele Aid.....	251				
Garage door opener.....	259				
		Operation	265		
		The first 1 000 miles (1 500 km).....	266		
		Driving instructions.....	267		
		Drive sensibly – save fuel.....	267		
		Drinking and driving.....	267		
		Pedals.....	267		
		Power assistance.....	267		
		Brakes.....	268		
		Driving off.....	269		
		Parking.....	269		
		Tires.....	270		
		Hydroplaning.....	271		
		Tire traction.....	271		
		Tire speed rating.....	272		
		Winter driving instructions.....	273		
		Standing water.....	274		
		Passenger compartment.....	274		
		Driving abroad.....	274		
		Control and operation of radio transmitters.....	275		
		Catalytic converter.....	275		
		Emission control.....	276		
		Coolant temperature.....	277		
		At the gas station.....	278		
		Refueling.....	278		
		Check regularly and before a long trip.....	280		
		Engine compartment.....	281		
		Hood.....	281		
		Engine oil.....	283		
		Transmission fluid level.....	286		
		Coolant.....	286		
		Battery.....	288		
		Windshield washer system and headlamp cleaning system*.....	289		
		Tires and wheels.....	290		
		Important guidelines.....	291		
		Life of tires.....	291		
		Direction of rotation.....	291		
		Checking tire inflation pressure ...	292		
		Rotating wheels.....	293		
		Winter driving.....	294		
		Winter tires.....	294		
		Block heater*.....	295		
		Snow chains.....	295		

Contents

Maintenance.....	296		Replacing bulbs.....	350
Clearing the service indicator	296	Practical hints	Bulbs.....	350
Service term exceeded	296	What to do if ...?	Replacing bulbs for front lamps	352
Calling up the service indicator....	297	Lamps in instrument cluster	Side marker lamp bulb.....	355
Resetting the service indicator....	297	Lamp in center console.....	Replacing bulbs for rear lamps	356
Vehicle care.....	298	Messages in the display.....	Replacing wiper blades	357
Cleaning and care of vehicle	298	Where will I find...?	Removing wiper blades.....	357
		First aid kit.....	Installing wiper blades	357
		Vehicle tool kit.....	Flat tire	358
		Minispare wheel.....	Preparing the vehicle	358
		Unlocking/locking in an emergency... 343	Mounting the Minispare wheel.....	358
		Unlocking the vehicle.....	Battery	363
		Locking the vehicle	Disconnecting the battery	364
		Changing batteries in	Removing the battery	364
		the SmartKey/ SmartKey	Charging and reinstalling battery..	364
		with KEYLESS-GO*	Reconnecting the battery	365
		Fuel filler flap	Jump starting.....	366
		Manually unlocking	Towing the vehicle.....	368
		the gear selector lever	Towing the vehicle	368
		Opening/closing in an emergency 348	Installing towing eye bolt.....	370
		Sliding/pop-up roof*	Fuses.....	372
			Fuse box in	
			passenger compartment.....	372
			Fuse box in engine compartment .	373
			Auxiliary fuse box in trunk	374

Contents

Technical data	375	Fuels, coolants, lubricants, etc.	388	Technical terms	397
Spare parts service	376	Capacities	388		
Warranty coverage	377	Engine oils.....	390		
Loss of Service and Warranty		Engine oil additives	390	Index	403
Information Booklet.....	377	Air conditioning refrigerant	390		
Identification labels.....	378	Brake fluid.....	390		
Layout of poly-V-belt drive	379	Premium unleaded gasoline	391		
CLK 320/CLK 500/CLK 55 AMG.	379	Fuel requirements	391		
Engine	380	Gasoline additives	391		
Rims and tires	381	Coolants.....	392		
Same size tires	382	Windshield washer system and			
Mixed size tires	383	headlamp cleaning system*	394		
Minispare wheel	384	Consumer information.....	395		
Electrical system.....	385	Uniform tire quality grading	395		
Main dimensions.....	386				
Weights.....	387				

▼ **Product information**

Please observe the following in your own best interest:

We recommend using genuine Mercedes-Benz parts as well as conversion parts and accessories explicitly approved by us for your vehicle model.

We have tested these parts to determine their reliability, safety and special suitability for Mercedes-Benz vehicles.

We are unable to make an assessment for other products and therefore cannot be held responsible for them, even if in individual cases an official approval or authorization by governmental or other agencies should exist. Use of such parts and accessories could adversely affect the safety, performance or reliability of your vehicle. Please do not use them.

Genuine Mercedes-Benz parts as well as conversion parts and accessories approved by us are available at your authorized Mercedes-Benz Center where you will receive comprehensive information, also on permissible technical modifications, and where proper installation will be performed.

Introduction

Operator's Manual

▼ Operator's Manual

This Operator's Manual contains a great deal of useful information. We urge you to read it carefully and familiarize yourself with the vehicle before driving.

For your own safety and longer service life of the vehicle, we urge you to follow the instructions and warnings contained in this manual. Ignoring them could result in damage to the vehicle or personal injury to you or others. Vehicle damage caused by failure to follow instructions is not covered by the Mercedes-Benz Limited Warranty.

Your vehicle may have some or all of the equipment described in this manual. Therefore, you may find explanations for optional equipment not installed in your vehicle. If you have any questions about the operation of any equipment, your authorized Mercedes-Benz Center will be glad to demonstrate the proper procedures.

We continuously strive to improve our product, and ask for your understanding that we reserve the right to make changes in design and equipment. Therefore, information, illustrations and descriptions in this Operator's Manual might differ from your vehicle.

Optional equipment is also described in this manual, including operating instructions wherever necessary. Since they are special-order items, the descriptions and illustrations herein may vary slightly from the actual equipment of your vehicle.

If there are any equipment details that are not shown or described in this Operator's Manual, your authorized Mercedes-Benz Center will be glad to inform you of correct care and operating procedures.

The Operator's Manual and Service Booklet are important documents and should be kept with the vehicle.

Service and warranty information

The Service and Warranty Information Booklet contains detailed information about the warranties covering your Mercedes-Benz, including:

- New Car Limited Warranty,
- Emission System Warranty,
- Emission Performance Warranty,
- California, Maine, Massachusetts, and Vermont Emission Control System Warranty (California, Maine, Massachusetts, and Vermont only),
- State Warranty Enforcement Laws (Lemon Laws).

Important notice for California retail buyers and lessees of Mercedes-Benz automobiles

Under California law you may be entitled to a replacement of your vehicle or a refund of the purchase price or lease price, if Mercedes-Benz USA, LLC and / or its authorized repair or service facilities fail to fix one or more substantial defects or malfunctions in the vehicle that are covered by its express warranty after a reasonable number of repair attempts. During the period of 18 months from original delivery of the vehicle or the accumulation of 18000 miles (approx. 29000 km) on the odometer of the vehicle, whichever occurs first, a reasonable number of repair attempts is presumed for a retail buyer or lessee if one or more of the following occurs:

- (1) the same substantial defect or malfunction results in a condition that is likely to cause death or serious bodily injury if the vehicle is driven, that defect or malfunction has been subject to repair two or more times, and you have directly notified Mercedes-Benz USA, LLC in writing of the need for its repair,
- (2) the same substantial defect or malfunction of a less serious nature than category (1) has been subject to repair four or more times and you have directly notified us in writing of the need for its repair, or
- (3) the vehicle is out of service by reason of repair of the same or different substantial defects or malfunctions for a cumulative total of more than 30 calendar days. Written notification should be sent to us, not a dealer, at Mercedes-Benz USA, LLC, Customer Assistance Center, One Mercedes Drive, Montvale, NJ 07645-0350.

Introduction

Operator's Manual

Maintenance

The Service Booklet describes all the necessary maintenance work which should be performed at regular intervals.

Always have the Service Booklet with you when you take the vehicle to your authorized Mercedes-Benz Center for service. The service advisor will record each service in the booklet for you.

Roadside Assistance

The Mercedes-Benz Roadside Assistance Program provides factory trained technical help in the event of a breakdown. Calls to the toll-free Roadside Assistance number

1-800-FOR-MERCEdes (in the USA)
1-800-387-0100 (in Canada)

will be answered by Mercedes-Benz Customer Assistance Representatives 24 hours a day, 365 days a year.

For additional information refer to the Mercedes-Benz Roadside Assistance Program Brochure in your glove box.

Change of address or ownership

If you change your address, be sure to send in the "Change of Address Notice" found in the Service and Warranty Information Booklet, or simply call the Mercedes-Benz Customer Assistance Center (in the USA) at 1-800-FOR-MERCEdes, or Customer Service (in Canada) at 1-800-387-0100. It is in your own interest that we can contact you should the need arise.

If you sell your Mercedes, please leave all literature with the vehicle to make it available to the next operator.

If you bought this vehicle used, be sure to send in the "Notice of Purchase of Used Car" found in the Service and Warranty Information Booklet, or call the Mercedes-Benz Customer Assistance Center (in the USA) at 1-800-FOR-MERCEdes, or Customer Service (in Canada) at 1-800-387-0100.

Operating your vehicle outside the USA or Canada

If you plan to operate your vehicle in foreign countries, please be aware that:

- service facilities or replacement parts may not be readily available,
- unleaded gasoline for vehicles with catalytic converters may not be available; the use of leaded fuels will damage the catalyts,
- gasoline may have a considerably lower octane rating, and improper fuel can cause engine damage.

Certain Mercedes-Benz models are available for delivery in Europe under our European Delivery Program. For details, consult your authorized Mercedes-Benz Center or write to:

In the USA:

Mercedes-Benz USA, LLC
European Delivery Department
One Mercedes Drive
Montvale, NJ 07645-0350

In Canada:

Mercedes-Benz Canada, Inc.
European Delivery Department
849 Eglinton Avenue East
Toronto, Ontario M4G 2L5

Introduction

Where to find it

▼ Where to find it

This Operator's Manual is designed to provide comprehensive support information for you, the vehicle operator. Each section has its own reference color so you can find information quickly.

At a glance

Here you will find an overview of all the controls that can be operated from the driver's seat.

Getting started

Here you will find all the information you need for your first drive. You should read this section first if this is your first Mercedes-Benz vehicle or if you are renting or borrowing this vehicle.

Safety and Security

Here you will find descriptions of the safety features in your vehicle.

Controls in detail

Here you will find detailed information about the equipment installed in your vehicle. This section expands on the "Getting started" section and also describes technical innovations. If you are already familiar with the basic functions of your vehicle, this section will be of particular interest to you.

Operation

Here you will find all the information you need for the proper operation of your vehicle.

Practical hints

This section provides fast assistance for dealing with problems you may encounter.

Technical data

All important technical data for your vehicle can be found in this section.

Indexes

The glossary provides explanations of the most important technical terms.

The table of contents and the index are designed to help you find information quickly and easily.

The following publications are part of your vehicle documentation:

- this Operator's Manual
- the Service Booklet

Separate operating instructions will be provided as required depending on the equipment options installed in your vehicle.

▼ Symbols

The following symbols are found in this Operator's Manual:

- * Optional equipment is identified with an asterisk. Since standard equipment varies between models, the descriptions and illustrations in this manual may differ slightly from the actual equipment of your vehicle.

Warning!



Warning notices draw your attention to hazards that may endanger your health or life, or the health or life of others.



Highlights hazards that may result in damage to your vehicle.



Helpful hints or further information you may find useful.

- ▶ This symbol points to instructions for you to follow.
- ▶ A number of these symbols appearing in succession indicates a multiple-step procedure.
- ▷ Page This symbol tells you where to look for further information on a topic.
- ▷▷ This continuation symbol marks an interrupted procedure which will be continued on the next page.
- > In the glossary of technical terms, this symbol is used to indicate cross-reference to term definitions.
- Display Words appearing in the multi-function display are printed in the type shown here.

Introduction

Operating safety

▼ Operating safety

Warning!



Work improperly carried out on electronic components and associated software could cause them to cease functioning. Because the vehicle's electronic components are interconnected, any modifications made may produce an undesired effect on other systems. Electronic malfunctions could seriously impair the operating safety of your vehicle.

See your authorized Mercedes-Benz Center for repairs or modifications to electronic components.

Other improper work or modifications on the vehicle could also have a negative impact on the operating safety of the vehicle.

Some safety systems only function while the engine is running. You should therefore never turn off the engine while driving.

Warning!



Heavy blows against the vehicle underbody or tires / wheels, for example when running over an obstacle, road debris or a pothole, may cause serious damage to and impair the operating safety of your vehicle. If you feel a sudden significant vibration or ride disturbance, or you suspect that damage to your vehicle has occurred, you should turn on your hazard warning flashers, carefully slow down, and drive with caution to an area which is a safe distance from the road.

Inspect the vehicle underbody and tires / wheels for possible damage. If the vehicle appears unsafe, have it towed to the nearest authorized Mercedes-Benz Center or other qualified maintenance or repair facility for further inspection or repairs.

Proper use of the vehicle

Proper use of the vehicle requires that you are familiar with the following information and rules:

- the safety precautions in this manual
- the “Technical data” section in this manual
- traffic rules and regulations
- motor vehicle laws and safety standards

Warning!



Various warning labels are attached to your vehicle. These warning labels are intended to make you and others aware of various risks. You should not remove any of these warning labels unless explicitly instructed to do so by information on the label itself. Removal of any of these labels may cause you and others to be unaware of certain risks which may result in an accident and/or personal injury.

▼ **Problems with your vehicle**

If you should experience a problem with your vehicle, particularly one that you believe may affect its safe operation, we urge you to immediately contact your authorized Mercedes-Benz Center to have the problem diagnosed and corrected if required. If the matter is not handled to your satisfaction, please discuss the problem with the Mercedes-Benz Center management, or if necessary contact us at one of the following addresses:

In the USA:

Customer Assistance Center
Mercedes-Benz USA, LLC
One Mercedes Drive
Montvale, NJ 07645-0350

In Canada:

Customer Relations Department
Mercedes-Benz Canada, Inc.
849 Eglinton Avenue East
Toronto, Ontario, M4G 2L5

Introduction

Reporting safety defects

▼ Reporting safety defects

For the USA only:

The following text is published as required of manufacturers under Title 49, Code of U.S. Federal Regulations, Part 575 pursuant to the “National Traffic and Motor Vehicle Safety Act of 1966”.

Reporting safety defects

If you believe that your vehicle has a defect which could cause a crash or could cause injury or death, you should immediately inform the National Highway Traffic Safety Administration (NHTSA) in addition to notifying Mercedes-Benz USA, LLC.

If NHTSA receives similar complaints, it may open an investigation, and if it finds that a safety defect exists in a group of vehicles, it may order a recall and remedy campaign. However, NHTSA cannot become involved in individual problems between you, your dealer, or Mercedes-Benz USA, LLC.

To contact NHTSA, you may either call the Auto Safety Hotline toll-free at 1-888-327-4236 (or 366-0123 in Washington, D.C. area) or write to: NHTSA, U.S. Department of Transportation, Washington, D.C. 20590. You can also obtain other information about motor vehicle safety from the Hotline.

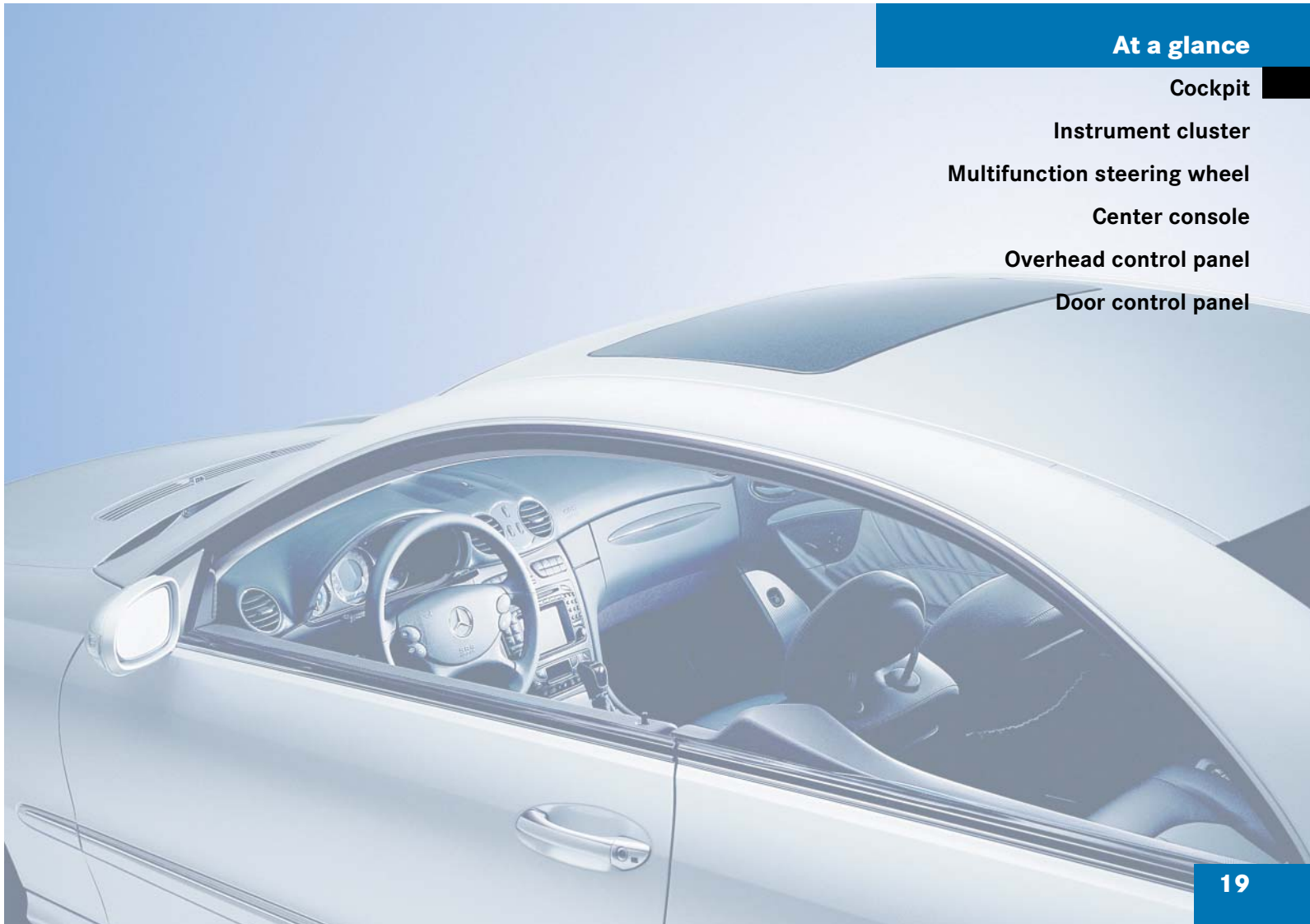

At a glance

Cockpit

Instrument cluster

Multifunction steering wheel

Center console

Overhead control panel

Door control panel

At a glance

Cockpit

▼ Cockpit

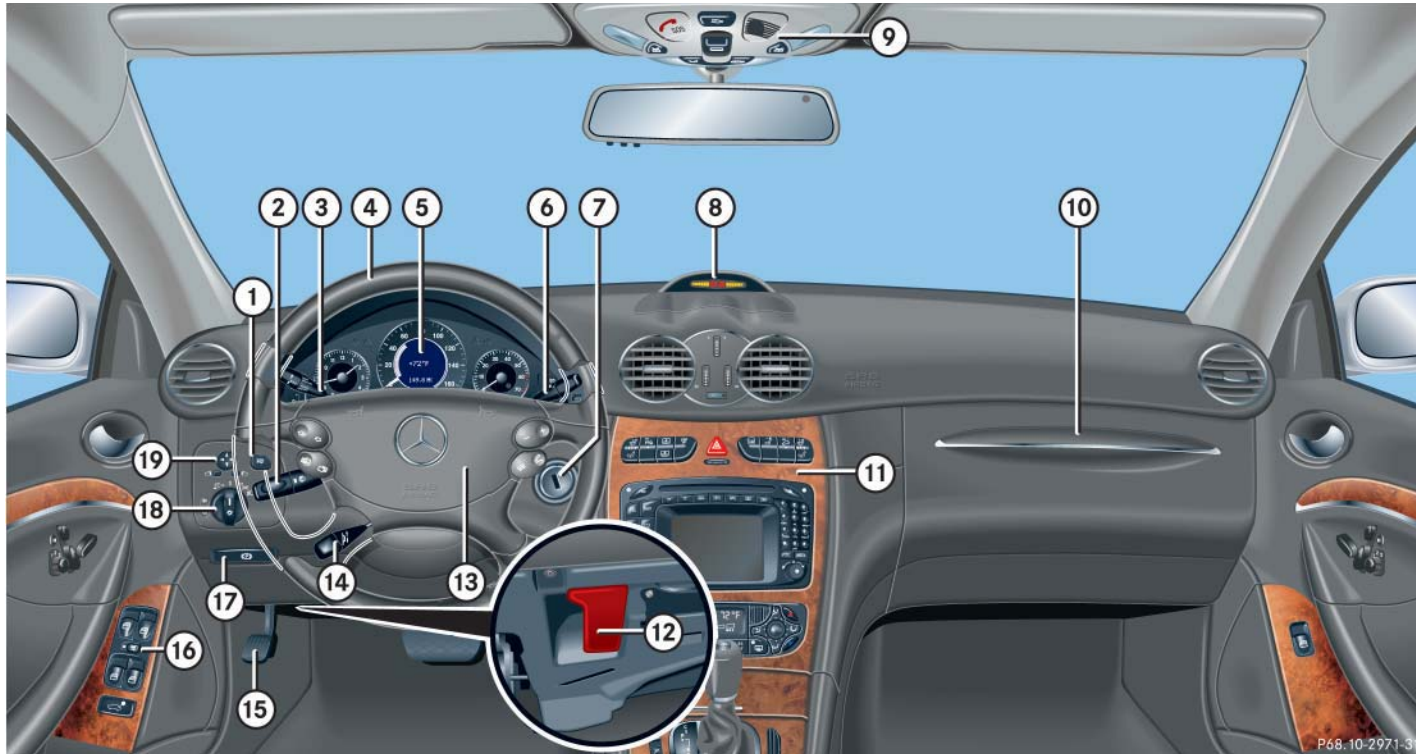

Item	Page
① Headlamp washer switch*	166
② Combination switch	
• Turn signals	48
• Windshield wipers	48
• High beam	48
③ Cruise control lever	
• Cruise control	218
• DISTRONIC*	221
④ Multifunction steering wheel	24, 130
⑤ Instrument cluster	22, 126
⑥ Lever for voice control system*, see separate operating instructions	
⑦ Starter switch	31

Item	Page
⑧ Front Parktronic* warning indicator	235
⑨ Overhead control panel	27
⑩ Glove box	244
⑪ Center console	25, 26
⑫ Hood lock release	281
⑬ Horn	
⑭ Steering wheel adjustment stalk	38
⑮ Parking brake pedal	46
⑯ Door control panel	28
⑰ Parking brake release	46
⑱ Exterior lamp switch	47, 119
⑲ Exterior rear view mirror adjustment	39

At a glance

Instrument cluster

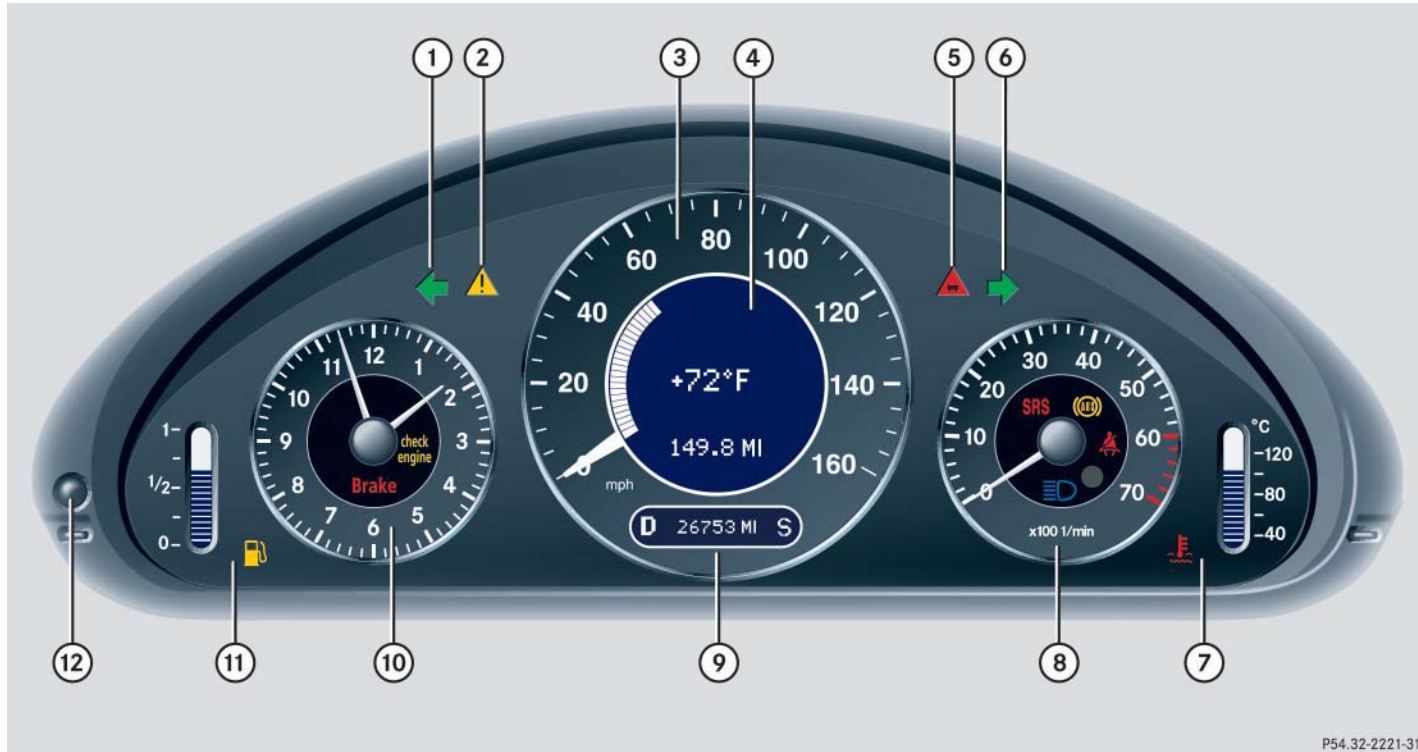

▼ Instrument cluster









P54.32-2221-31

At a glance

Instrument cluster

Item	Page
①  Left turn signal indicator lamp	48
②  ESP warning lamp	310
③ Speedometer	
④ Multifunction display with:	129
Basic display with outside temperature display	134, 144
Status indicator with malfunction warning message	134, 138
Trip odometer	127
⑤  Distance warning lamp	310
Vehicles without Distronic*: Warning lamp without function. It illuminates with the ignition on. It should go out when the engine is running.	

Item	Page
⑥  Right turn signal indicator lamp	48
⑦ Coolant temperature indicator with:	127
 Coolant temperature warning lamp	309, 323
⑧ Tachometer with:	128
SRS Supplemental restraint system indicator lamp	312, 334
 Antilock Brake System (ABS) warning lamp	306
 Seat belt non-usage warning lamp	311, 333
 High beam headlamp indicator	123
⑨ Main odometer with:	
• Gear selector lever position	160
• Program mode	163

Item	Page
⑩ Clock with:	144
BRAKE Brake warning lamp, except Canada	307
 Brake warning lamp, Canada only	
CHECK ENGINE Engine malfunction indicator lamp	308
⑪ Fuel display with:	
 Fuel reserve warning lamp	311
⑫ Reset button for:	
• Resetting trip odometer	127
• Adjusting instrument cluster illumination	126
• Confirming new time settings	144

At a glance

Multifunction steering wheel

▼ Multifunction steering wheel



	Item	Page
①	Multifunction display	129
	Operating control system	130
②	Selecting the submenu or setting the volume	
	down / to decrease	
	up / to increase	
③	Telephone*: Press button	
	to take a call	155
	to dial a call	155
	to end a call	155
	to reject an incoming call	

	Item	Page
④	Menu systems: Press button	
	for next system	
	for previous system	
⑤	Moving within a menu: Press button	
	for next display	
	for previous display	

At a glance

Center console

▼ Center console

Upper part



Item	Page
① Seat heater*, driver's side Seat ventilation*, driver's side	114
② Parking assist* (Parktronic system*) deactivation switch	236
③ Rear window sunshade*	170
④ ESP control switch	78
⑤ Hazard warning flasher on/off switch	123
⑥ Central locking switch	106
⑦ Rear head restraints, folding down switch	110

Item	Page
⑧ Tow-away alarm switch	83
Anti-theft alarm system indicator lamp	84
⑨ Seat heater*, passenger side Seat ventilation*, passenger side	114
⑩ PASS. AIRBAG OFF indicator lamp	70, 313
⑪ Audio system or COMAND* (see separate operating instructions)	134
⑫ Automatic climate control Rear window defroster	172, 171
⑬ Ashtray	247

At a glance

Center console

Lower part

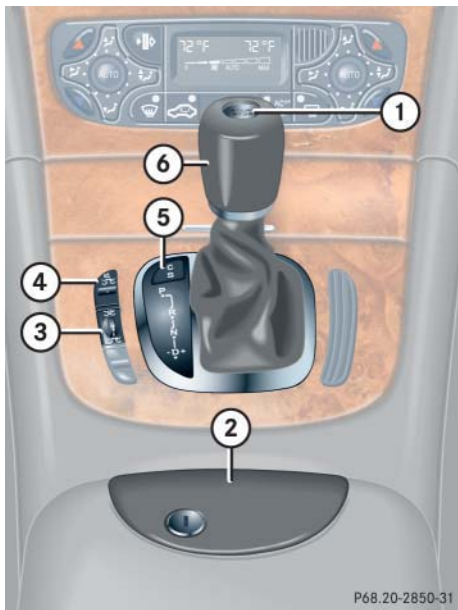

Item	Page
① KEYLESS-GO* start/stop button	33
② Storage compartment	246
③ Thumbwheel for setting distance in DISTRONIC*	228
④ Distance warning function* on/off switch	229

Item	Page
⑤ Program mode selector for automatic transmission	163, 164
⑥ Gear selector lever for automatic transmission	157

At a glance

Overhead control panel

▼ Overhead control panel

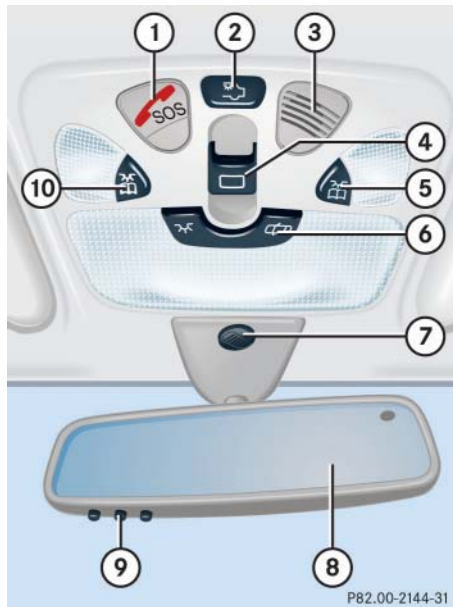

Item	Page
① Tele Aid (emergency call system) button	251
② Rear interior lighting on/off	125
③ Temperature sensor for automatic climate control	172
④ Sliding/pop-up roof*	214
⑤ Right reading lamp on/off	125
⑥ Interior lighting control	124

Item	Page
⑦ Hands-free microphone for Tele Aid (emergency call system), telephone* and voice control system* (see separate operating instructions)	250
⑧ Rear view mirror	38, 167
⑨ Garage door opener	259
⑩ Left reading lamp on/off	125

At a glance

Door control panel

▼ Door control panel

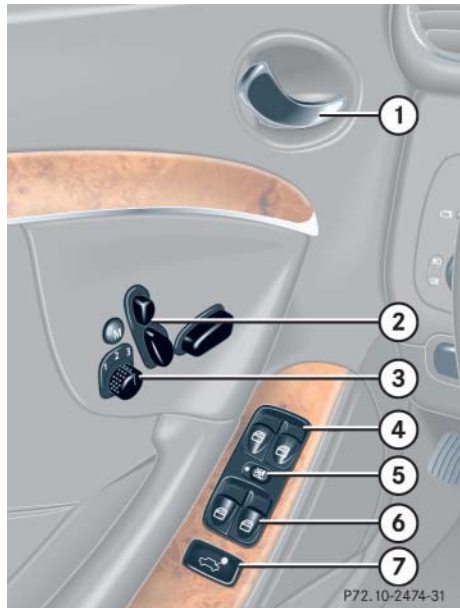

	Item	Page
①	Door handle	95
②	Seat adjustment	35, 107
③	Memory function (for storing seat, exterior mirror and steering wheel settings)	116
④	Switches for opening/closing front door windows	212
⑤	Rear window override switch	74
⑥	Switches for opening/closing rear windows	212
⑦	Remote trunk lid release switch	97
	Trunk lid opening/closing system switch*	98



Getting started

Unlocking

Adjusting

Driving

Parking and locking

Getting started

Unlocking

The “Getting started” section provides an overview of the vehicle’s most basic functions. First-time Mercedes-Benz owners should pay special attention to the information given here.



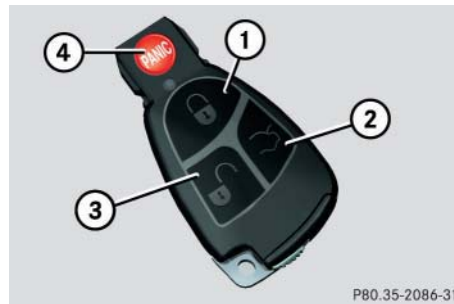

If you are already familiar with the basic functions described here, the “Controls in detail” section will provide you with further information. The corresponding page references are located at the end of each segment.

▼ Unlocking

Unlocking with the SmartKey



SmartKey with remote control

- ①  Lock button
- ②  Opening button for trunk lid
- ③  Unlock button
- ④  Panic button (▷ page 75)

- ▶ Press unlock button  on the SmartKey.

All turn signal lamps flash once. The locking knobs in the doors move up.

- ▶ Get in the vehicle and insert the SmartKey in the starter switch.

i

Opening a door causes the windows on that side of the car to open slightly. They will return to the up position when the door is closed.

For more information, see “Locking and unlocking” (▷ page 86).

Starter switch positions

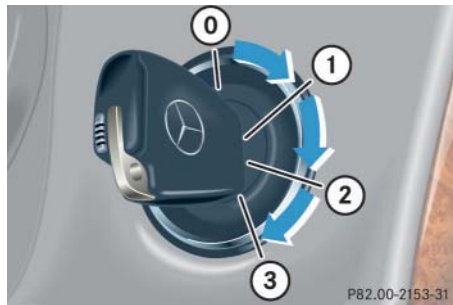

Starter switch

- 0** For removing SmartKey
- 1** Power supply to some electrical consumers, such as seat adjustment
- 2** Ignition (power supply for all electrical consumers) and driving position
- 3** Starting position

Warning!



When leaving the vehicle, always remove the SmartKey from the starter switch, take the SmartKey with KEYLESS-GO* with you and lock the vehicle. Do not leave children unattended in the vehicle, or with access to an unlocked vehicle. Unsupervised use of vehicle equipment may cause an accident and/or serious personal injury.



The SmartKey can only be removed from the starter switch with the gear selector lever in position **P**.



If the SmartKey cannot be turned in the starter switch, the battery may not be sufficiently charged.

- ▶ Check the battery and charge it if necessary (▷ page 363).
- ▶ Get a jump start (▷ page 366).

To prevent accelerated battery discharge and a possible dead battery, always remove the SmartKey from the starter switch when the engine is not in operation.

Getting started

Unlocking

Unlocking with KEYLESS-GO*

If you have the KEYLESS-GO function, your vehicle checks whether the SmartKey with KEYLESS-GO is valid when you pull the door handle. If your SmartKey is valid, the doors will unlock, and you can open them.

The function of the SmartKey overrides the KEYLESS-GO function.



To unlock the vehicle, the SmartKey with KEYLESS-GO must be outside the vehicle, no further than approx. 3 feet (1 meter) away from the door.

- ▶ Pull the door handle.
The turn signal lamps flash once. The locking knobs on the doors move up.

If the SmartKey is inside the vehicle, pressing the KEYLESS-GO start/stop button on the gear selector lever corresponds to turning the SmartKey to the various starter switch positions.

Warning!



When leaving the vehicle, always take the SmartKey with KEYLESS-GO with you, and lock the vehicle. Do not leave children unattended in the vehicle, or with access to an unlocked vehicle. Unsupervised use of vehicle equipment may cause an accident and/or serious personal injury.



① KEYLESS-GO start/stop button

The SmartKey with KEYLESS-GO must be located in the vehicle.

Before you press the KEYLESS-GO start/stop button, the vehicle's on-board electronics have status **0** (as with SmartKey removed).

- ▶ Make sure the gear selector lever is set to **P**.
- ▶ Do not depress the brake pedal.

Position 1

- ▶ Press the KEYLESS-GO start/stop button once.

This supplies power to some electrical consumers, such as seat adjustment.



If you now press the KEYLESS-GO start/stop button

- once again, the ignition (position **2**) is switched on.
- twice, the power supply is again switched off.

Getting started

Unlocking

Ignition (or position 2)

- ▶ Press the KEYLESS-GO start/stop button twice.

This supplies power to all electrical consumers. All the lamps in the instrument cluster come on.



If you now press the KEYLESS-GO start/stop button once, the power supply is again switched off.

More information can be found in the “Controls in detail” section (▷ page 89). For information on starting the engine using the KEYLESS-GO start/stop button, see “Starting with KEYLESS-GO*” (▷ page 44).

Getting started

Adjusting

▼ Adjusting

Warning!



All seat, head restraint, steering wheel, and rear view mirror adjustments, as well as fastening of seat belts, must be done before the vehicle is put into motion.

Seats

Warning!



Do not adjust the driver's seat while driving. Adjusting the seat while driving could cause the driver to lose control of the vehicle.

Never ride in a moving vehicle with the seat back reclined. Sitting in an excessively reclined position can be dangerous. You could slide under the seat belt in a collision. If you slide under it, the belt would apply force at the abdomen or neck. That could cause serious or fatal injuries. The seat back and seat belts provide the best restraint when the wearer is in an upright position and belts are properly positioned on the body.

Your seat must be adjusted so that you can correctly fasten your seat belt (▷ page 40).

Never place hands under the seat or near any moving parts while a seat is being adjusted.

Warning!



When leaving the vehicle, always remove the SmartKey from the starter switch, take the SmartKey with KEYLESS-GO* with you, and lock your vehicle.

The power seats can also be operated with the driver's or passenger door open. Do not leave children unattended in the vehicle, or with access to an unlocked vehicle. Unsupervised use of vehicle equipment may cause an accident and/or serious personal injury.

Warning!



Children 12 years old and under must never ride in the front seat, except in a Mercedes-Benz authorized BabySmart^{TM1} compatible child seat, which operates with the BabySmartTM system installed in the vehicle to deactivate the passenger front airbag when it is properly installed. Otherwise they will be struck by the airbag when it inflates in a crash. If this happens, serious or fatal injury will result.

According to accident statistics, children are safer when properly restrained in the rear seating positions than in the front seating positions. Infants and small children must ride in back seats and be seated in an appropriate infant or child restraint system, which is properly secured with the vehicle's seat belt and top tether strap, or secured via lower anchors and top tether strap, fully in accordance with the child seat manufacturer's instructions.

¹ BabySmartTM is a trademark of Siemens Automotive Corp.

A child's risk of serious or fatal injuries is significantly increased if the child restraints are not properly secured in the vehicle and the child is not properly secured in the child restraint.

Seat adjustment

The seat adjustment switches are located in each door.

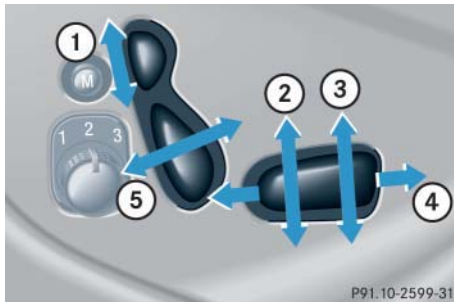

- ① Head restraint height
- ② Seat height
- ③ Seat cushion tilt
- ④ Seat fore and aft adjustment
- ⑤ Backrest tilt

- ▶ Turn the SmartKey in the starter switch to position **1** or **2** (▷ page 31).
- or
- ▶ Press the KEYLESS GO* start/stop button once or twice (▷ page 33).
- or
- ▶ Open the driver's or passenger door.

Seat fore and aft adjustment

- ▶ Press the switch forward or backward in the direction of arrow ④.

Adjust seat to a comfortable seating position that still allows you to reach the accelerator / brake pedal safely. The position should be as far to the rear as possible, consistent with ability to properly operate controls.



When moving the seat, be sure that there are no items in the footwell or behind the seats. Otherwise you could damage the seats.

The memory function (▷ page 116) lets you store the setting for the seat position together with the setting for the steering wheel and the exterior rear view mirrors.

Getting started

Adjusting

Getting started

Adjusting

Seat cushion tilt

- ▶ Press the switch up or down in the direction of arrow ③ until your upper legs are lightly supported.

Seat backrest tilt

- ▶ Press the switch forward or backward in the direction of arrow ⑤ until your arms are slightly angled when holding the steering wheel.

Seat height

- ▶ Press the switch up or down in the direction of arrow ②.

Head restraint height

- ▶ Press the switch up or down in the direction of arrow ①.

Warning!



For your protection, drive only with properly positioned head restraints.

Adjust head restraint so that the center of the head restraint supports the back of the head at eye level. This will reduce the potential for injury to the head and neck in the event of an accident or similar situation.

Do not drive the vehicle without the seat head restraints. Head restraints are intended to help reduce injuries during an accident.

Head restraint tilt

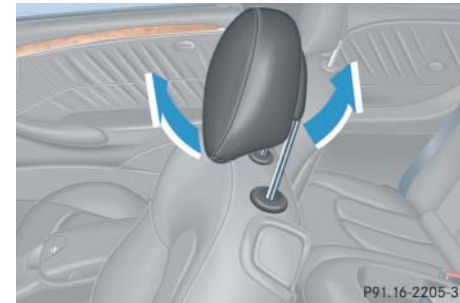

Manually adjust the angle of the head restraint.

- ▶ Push or pull on the lower edge of the head restraint cushion.

For more information, see “Seats” (▷ page 107).

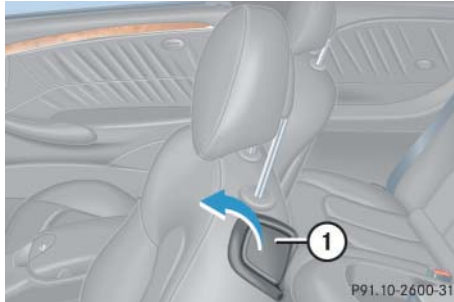
Folding front seat backrests forward

① Release lever



In addition to the front seat backrests, the front seat cushions can also be shifted forward to permit easy access to the rear whenever the seat is located in the rear half of its adjustment range. Swivel backrest forward by pulling the release lever until the seat moves in a combined forward and upward movement.

Folding backrests forward

- ▶ Pull release lever ① forward and fold the backrest forward.

The head restraint will automatically move down.

Folding backrests back

- ▶ Fold and press the backrest rearward until it engages in driving position.

The head restraint returns to its previous position.

For more information, see “Easy-entry/ex-
it feature” (▷ page 107).

Steering wheel**Warning!**

Do not adjust the steering wheel while driving. Adjusting the steering wheel while driving could cause the driver to lose control of the vehicle.

When leaving the vehicle, always remove the SmartKey from the starter switch, take the SmartKey with KEYLESS-GO* with you and lock your vehicle.

The steering wheel adjustment feature can also be operated with the driver's door open. Do not leave children unattended in the vehicle, or with access to an unlocked vehicle. Unsupervised use of vehicle equipment may cause an accident and/or serious personal injury.

Getting started

Adjusting

Steering wheel adjustment

The stalk for steering wheel adjustment is located on the steering column (lower left).

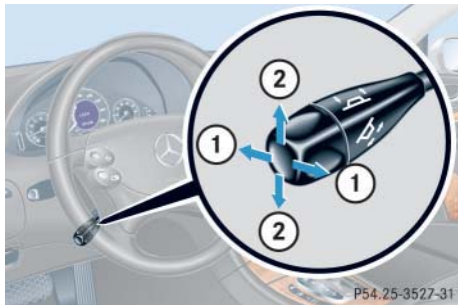

- ① Adjusting steering column, in or out
- ② Adjusting steering column, up or down

- ▶ Turn the SmartKey in the starter switch to position **1** or **2** (▷ page 31).

or

- ▶ Press the KEYLESS GO* start/stop button once or twice (▷ page 33).

or

- ▶ Open the driver's door.

Adjusting steering column in or out

- ▶ Move stalk forward or back in the direction of arrow ① until a comfortable steering wheel position is reached with your arms slightly bent at the elbow.

Adjusting steering column up or down

- ▶ Move stalk up or down in the direction of arrow ②.

Make sure your legs can move freely and all the displays (incl. malfunction and indicator lamps) on the instrument cluster are clearly visible.



The memory function (▷ page 116) lets you store the setting for the steering wheel together with the setting for the seat position and exterior rear view mirrors.

Mirrors

Adjust the interior and exterior rear view mirrors before driving so that you have a good view of the road and traffic conditions.

Warning!



In the case of an accident, liquid electrolyte may escape the mirror housing if the mirror glass breaks.

Electrolyte has an irritating effect. Do not allow the liquid to come into contact with eyes, skin, clothing, or respiratory system. In case it does, immediately flush affected area with water, and seek medical help if necessary.

Interior rear view mirror

- ▶ Manually adjust the interior rear view mirror.

For more information, see “Rear view mirror” (▷ page 167)

Exterior rear view mirror

Warning!

Exercise care when using the passenger side exterior rear view mirror. The mirror surface is convex (outwardly curved surface for a wider field of view). Objects in mirror are closer than they appear. Check your interior rear view mirror or glance over your shoulder before changing lanes.



Electrolyte drops coming into contact with the vehicle paint finish can only be completely removed while in their liquid state and by applying plenty of water

The buttons are located above the exterior lamp switch.

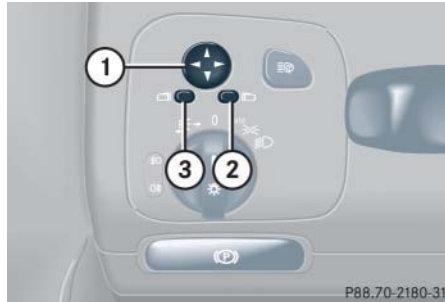

- ① Adjustment button
 - ② Passenger-side exterior rear view mirror button
 - ③ Driver's side exterior rear view mirror button
- ▶ Make sure the ignition is switched on. All the lamps in the instrument cluster come on.
 - ▶ Press button ③ for the left mirror or button ② for the right mirror.
 - ▶ Push adjustment button ① up, down, left or right according to the desired setting.



If an exterior rear view mirror was forcibly pushed forward (hit from the rear) or forcibly pushed rearward (hit from the front), reposition it by applying firm pressure until it snaps into place. The mirror housing is now properly positioned and you can adjust the mirror normally.



The memory function (> page 116) lets you store the setting for the exterior rear view mirrors together with the settings for the steering wheel and seat position.



At low ambient temperatures, the mirrors will be heated automatically.

For more information, see “Activating exterior rear view mirror parking position” (> page 168).

Getting started

Driving

▼ Driving

Warning!



Do not lay any objects in the driver's footwell. Be careful that floor mats or carpets in the driver's footwell have sufficient clearance for the pedals.

During sudden driving or braking maneuvers, the objects could get caught between the pedals. You could then no longer brake or accelerate.

Fastening the seat belts

Warning!



Always fasten your seat belt before driving off. Always make sure your passengers are properly restrained, even those sitting in the rear and pregnant women.

Failure to wear and properly fasten and position your seat belt greatly increases your risk of injuries and their likely severity in an accident. You and your passengers should always wear seat belts.

If you are ever in an accident, your injuries can be considerably more severe without your seat belt properly buckled. Without your seat belt buckled, you are much more likely to hit the interior of the vehicle or be ejected from it. You can be seriously injured or killed.

In the same crash, the possibility of injury or death is lessened if you are wearing your seat belt. The airbags can only protect as expected if the occupants are using their seat belts (▷ page 58).

Warning!



Children 12 years old and under must never ride in the front seat, except in a Mercedes-Benz authorized BabySmartTM¹ compatible child seat, which operates with the BabySmartTM system installed in the vehicle to deactivate the passenger front airbag when it is properly installed. Otherwise they will be struck by the airbag when it inflates in a crash. If this happens, serious or fatal injury will result.

¹ BabySmartTM is a trademark of Siemens Automotive Corp.

According to accident statistics, children are safer when properly restrained in the rear seating positions than in the front seating positions. Infants and small children must ride in back seats and be seated in an appropriate infant or child restraint system, which is properly secured with the vehicle's seat belt and top tether strap, or secured via lower anchors and top tether strap, fully in accordance with the child seat manufacturer's instructions.

A child's risk of serious or fatal injuries is significantly increased if the child restraints are not properly secured in the vehicle and the child is not properly secured in the child restraint.

Warning!



Never let more people ride in the vehicle than there are seat belts available. Be sure everyone riding in the vehicle is correctly restrained with a separate seat belt.

Warning!



Never ride in a moving vehicle with the seat backrest reclined. Sitting in an excessively reclined position can be dangerous. You could slide under the seat belt in a collision. If you slide under it, the belt would apply force at the abdomen or neck. This could cause serious or even fatal injuries. The seat backrest and seat belt provide the best restraint when the wearer is in an upright position and the belt is properly positioned on the body.

Warning!



Read and observe the additional warning notices printed in the "Safety and Security" section (▷ page 62).

Getting started

Driving

The seat belt presenter for driver and passenger makes it easier to put on the seat belt.

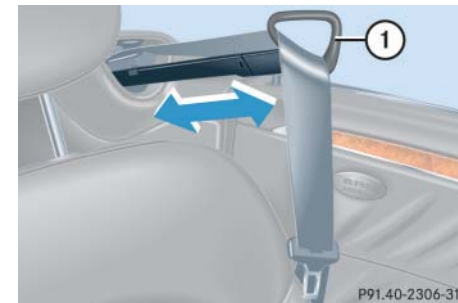

① Seat belt presenter

The seat belt presenter slides out when the corresponding door is closed and the SmartKey in the starter switch or KEYLESS-GO* start/stop button are in position **1** or **2**.

Getting started

Driving

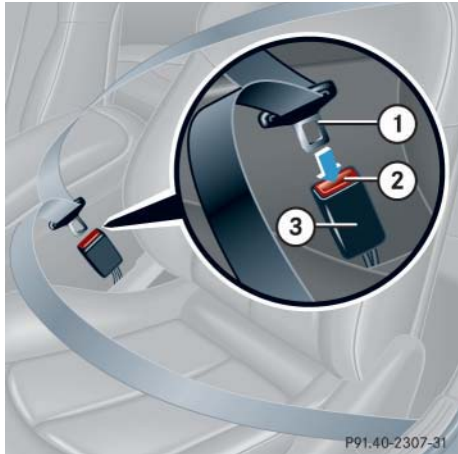

- ① Latch plate
- ② Release button
- ③ Buckle

- ▶ With a smooth motion, pull the belt out of the seat belt presenter.
- ▶ Place the belt over your shoulder.
- ▶ Push latch plate ① into buckle ③ until it clicks.
- ▶ If necessary, tighten the lap portion to a snug fit by pulling shoulder portion up.

Proper use of seat belts

- Do not twist the belt when fastening.
- Adjust seat belt so that the shoulder portion is located as close as possible to the middle of the shoulder (it should not touch the neck or pass under the arm).
- Position the lap belt as low as possible on your hips (over hip joint) and not across the abdomen.
- Place the seat backrest in a nearly upright position.
- Never use a seat belt for more than one person at a time.
- Do not fasten a seat belt around a person and another object at the same time.
- Check your seat belt during travel to ensure that it is properly positioned.
- Ensure that the seat belt is always fitted snugly. You should avoid wearing bulky clothing, such as winter coats, when traveling in the vehicle.

Warning!



Do not pass belts over sharp edges. They could tear.

Do not allow the belt to get caught in the door or in the seat adjustment mechanism. This could damage the belt.

Never attempt to make modifications to seat belts. This could impair the effectiveness of the belts.

Damaged seat belts or belts that were highly stressed in an accident must be replaced. Contact an authorized Mercedes-Benz Center.

The seat belt presenter slides back:

- right after you pushed the latch plate ① into buckle ③ and heard it click.
- after approximately 30 seconds if you did not push latch plate ① into buckle ③.
- if your door is opened.
- if you turn the SmartKey in the starter switch to position **0**.
- if you release a front seat backrest and fold it forward.

Warning!



The seat belt presenter must be retracted while the vehicle is in motion. Only when the seat belt presenter is retracted can the seat belt be properly positioned on the body and protect the occupant as intended.

Starting the engine

Warning!



Inhalation of exhaust gas is hazardous to your health. All exhaust gas contains carbon monoxide, and inhaling it can cause unconsciousness and lead to death.

Do not run the engine in confined areas (such as a garage) which are not properly ventilated. If you think that exhaust gas fumes are entering the vehicle while driving, have the cause determined and corrected immediately. If you must drive under these conditions, drive with at least one window fully open.

Getting started

Driving

Automatic transmission

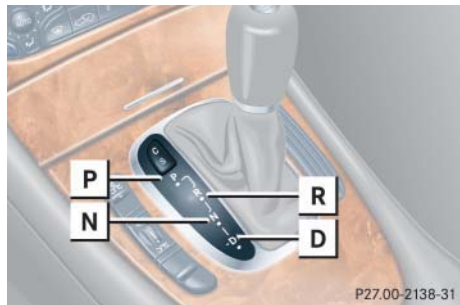

Gearshift pattern for automatic transmission

- P** Park position with gear selector lever lock
- R** Reverse gear
- N** Neutral
- D** Drive position

For more information, see “Automatic transmission” (▷ page 157).

Starting with the SmartKey

- ▶ Make sure the gear selector lever is set to **P**.
- ▶ Do not depress accelerator
- ▶ Turn the SmartKey in the starter switch to position **3** (▷ page 31) and release it again immediately (“touch-start”).
The engine then starts automatically.
- ▶ Depress the brake pedal.

The gear selector lever lock is released.

For information on turning off the engine with the SmartKey, see (▷ page 53).

Starting with KEYLESS-GO*

You can start your vehicle without the SmartKey in the starter switch using the KEYLESS-GO start/stop button on the gear selector lever.

The SmartKey with KEYLESS-GO must be located in the vehicle.



① KEYLESS-GO start/stop button

- ▶ Make sure the gear selector lever is set to **P**.
- ▶ Do not depress accelerator
- ▶ Depress the brake pedal during the starting procedure.
The gear selector lever lock is released.
- ▶ Press KEYLESS-GO start/stop button ① once.
The engine starts automatically if the SmartKey with KEYLESS-GO is in the vehicle.

For information on turning off the engine with KEYLESS-GO, see “Turning off the engine with KEYLESS-GO*” (▷ page 54).

Starting difficulties

If the engine does not start as described, carry out the following steps:

- ▶ If you are starting the engine with the SmartKey, turn SmartKey in starter switch to position **0** and repeat starting procedure.
- ▶ If you are starting the engine with KEYLESS-GO*: Close any doors that may be open to allow for better detection of the SmartKey with KEYLESS-GO*.

Or:

Start the engine with the SmartKey as radio signals from another source may be interfering with the SmartKey with KEYLESS-GO*.

Getting started

Driving

- ▶ Repeat the starting procedure (▷ page 43). Remember that extended starting attempts can drain the battery.
- ▶ Get a jump start (▷ page 366).

If the engine does not start after several starting attempts, there could be a malfunction in the engine electronics or in the fuel supply system.

- ▶ Notify an authorized Mercedes-Benz Center.

Getting started

Driving

Parking brake

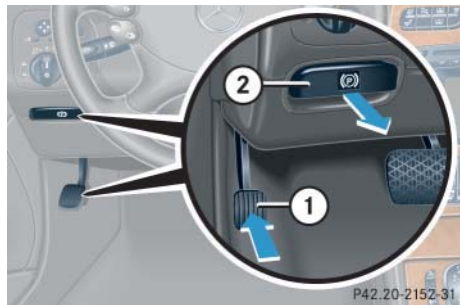

- ① Parking brake pedal
- ② Parking brake release handle

- ▶ Release the parking brake by pulling on handle ②.

The indicator lamp **BRAKE** (USA only) or  (Canada only) in the clock goes out.

Warning!



When leaving the vehicle, always remove the SmartKey from the starter switch, take the SmartKey with KEYLESS-GO* with you and lock the vehicle. Do not leave children unattended in the vehicle, or with access to an unlocked vehicle. Children could release the parking brake, which could result in an accident and/or serious personal injury.

Driving

- ▶ Depress the brake pedal.
- ▶ Move gear selector lever in position **D** or **R**.
- ▶ Release the brake pedal.
- ▶ Carefully depress the accelerator pedal.

Once the vehicle is in motion, the automatic central locking system engages and the locking knobs drop down.

i

You can open a locked door from the inside. Open doors only when conditions are safe to do so.

You can deactivate the automatic locking using the control system (> page 149).

!

If you hear a warning signal when driving off, you have forgotten to release the parking brake.

Release the parking brake.

After a cold start, the automatic transmission shifts at a higher engine revolution. This allows the catalytic converter to reach its operating temperature earlier.

i

Wait for the gear selection process to complete before setting the vehicle in motion.

Warning!

It is dangerous to shift the gear selector lever out of **P** or **N** if the engine speed is higher than idle speed. If your foot is not firmly on the brake pedal, the vehicle could accelerate quickly forward or in reverse. You could lose control of the vehicle and hit someone or something. Only shift into gear when the engine is idling normally and when your right foot is firmly on the brake pedal.



Simultaneously depressing the accelerator pedal and applying the brake reduces engine performance and causes premature brake and drivetrain wear.

Warning!

On slippery road surfaces, never downshift in order to obtain braking action. This could result in drive wheel slip and reduced vehicle control. Your vehicle's ABS will not prevent this type of loss of control.



Place the gear selector lever in position **R** only when the vehicle is stopped in order to avoid damaging the transmission.



Do not run cold engine at high engine speeds. Running a cold engine at high engine speeds may shorten the service life of the engine.

Switching on headlamps**Exterior lamp switch**

- ① Off
- ② Low beam headlamps on

► Turn the switch to .

For more information, see “Exterior lamp switch” (> page 119).

Getting started

Driving

Turn signals and high beam

The combination switch is located on the left of the steering column.



Combination switch

- ① Turn signals, right
- ② Turn signals, left

- ▶ Press the combination switch up ① or down ②.



To signal minor directional changes, move combination switch to point of resistance only and release. The turn signal flashes three times.

High beam

- ▶ Push the combination switch forward.
- The high beam headlights are switched on.
The high beam symbol  in the tachometer comes on.

For more information, see “High beam flasher” (> page 123).

Windshield wipers

The combination switch is located on the left of the steering column.

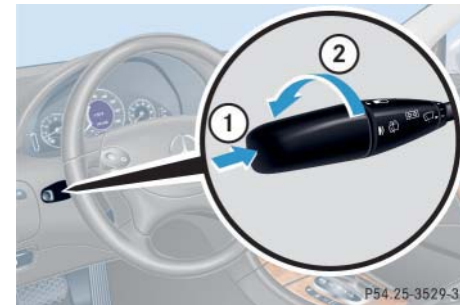

Combination switch

- ① Single wipe
- ② Switching on windshield wipers

- ▶ Make sure the ignition is switched on.

Switching on windshield wipers

- ▶ Turn the combination switch to the desired position depending on the intensity of the rain.

- 0** Windshield wipers off
- I** Intermittent wiping
- II** Normal wiper speed
- III** Fast wiper speed



The intermittent wiping interval is dependent on wetness of windshield. Wiping will not occur with a door open.



Do not leave windshield wipers in intermittent setting when the vehicle is taken to an automatic car wash or during windshield cleaning. Wipers will operate in the presence of water sprayed on the windshield, and wipers may be damaged as a result.

The switch should not be left in intermittent setting as the wipers will wipe the windshield once every time the engine is started. Dust that accumulates on the windshield might scratch the glass and/or damage the wiper blades when wiping occurs on a dry windshield.

Single wipe

- ▶ Press combination switch briefly in the direction of arrow ①.

The windshield wipers wipe one time without washer fluid.

Wiping with windshield washer fluid

- ▶ Push combination switch in the direction of arrow ① past the resistance point.

The windshield wipers operate with washer fluid.

For information on filling up the washer reservoir, see “Windshield washer system and headlamp cleaning system*” (▷ page 289).



If anything blocks the windshield wipers (leaves, snow, etc.), switch them off immediately.

- For safety reasons,
 - turn off the engine by turning the SmartKey to position **0** and withdraw SmartKey from starter switch

or



Getting started

Driving



- turn off the engine by pressing the KEYLESS-GO* start/stop button and open the driver's door (with the driver's door open, starter switch is in position **0**, same as with SmartKey removed from starter switch)

before attempting to remove any blockage.

- Remove blockage.
- Turn the windshield wipers on again.

If windshield wipers fail to function at all in switch position **I**,

- set the combination switch to the next highest wiper speed
- have the windshield wipers checked at the nearest authorized Mercedes-Benz Center

Problems while driving

The engine runs erratically and misfires

- An ignition cable may be damaged.
- The engine electronics may not be operating properly.
- Unburned gasoline may have entered the catalytic converter and damaged it.
 - ▶ Give very little gas.
 - ▶ Have the problem repaired by an authorized Mercedes-Benz Center as soon as possible.

The coolant temperature is over 248°F (120°C)

The coolant is too hot and is no longer cooling the engine.

- ▶ Stop the vehicle as soon as possible and turn off the engine. Allow engine and coolant to cool.
- ▶ Check the coolant level and add coolant if necessary (▷ page 286).

In case of accident

If the vehicle is leaking gasoline:

- ▶ Do not start the engine under any circumstances.
- ▶ Notify local fire and/or police authorities.

If the extent of the damage cannot be determined:

- ▶ Notify an authorized Mercedes-Benz Center.

If no damage can be determined on the

- major assemblies
- fuel system
- engine mount
- ▶ Start the engine in the usual manner.

▼ Parking and locking

You have now completed your first drive. You have properly stopped and parked your vehicle. End your drive as follows:

Warning!



Wait until the vehicle is stationary before removing the SmartKey from the starter switch. The vehicle cannot be steered when the SmartKey is removed.

Warning!



With the engine not running, there is no power assistance for the brake and steering systems. In this case, it is important to keep in mind that a considerably higher degree of effort is necessary to brake and steer the vehicle.

Warning!



Do not park this vehicle in areas where combustible materials such as grass, hay or leaves can come into contact with the hot exhaust system, as these materials could be ignited and cause a vehicle fire.

To reduce the risk of personal injury as a result of inadvertent vehicle movement, before turning off the engine and leaving the vehicle always:

- Keep right foot on brake pedal.
- Firmly depress parking brake pedal.
- Move the gear selector lever to position **P**.
- Slowly release brake pedal.
- When parked on an incline, turn front wheel towards the road curb.

Getting started

Parking and locking

- Turn the SmartKey to starter switch position **0** and remove, or press start / stop button (vehicles with KEYLESS-GO*).
- Take the SmartKey or the SmartKey with KEYLESS-GO* and lock vehicle when leaving.

Getting started

Parking and locking

Parking brake

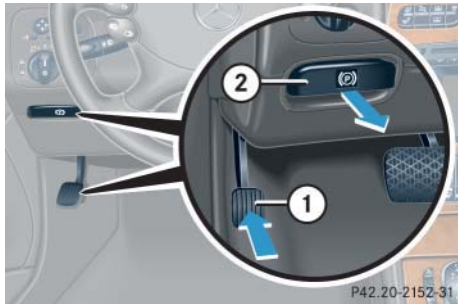

- ① Parking brake
- ② Release handle

- ▶ Step firmly on parking brake ①.

When the engine is running, the indicator lamp **BRAKE** (USA only) or **(P)** (Canada only) in the instrument cluster will be illuminated.

Warning!



When leaving the vehicle, always remove the SmartKey from the starter switch, take the SmartKey with KEYLESS-GO* with you and lock the vehicle. Do not leave children unattended in the vehicle, or with access to an unlocked vehicle. Children could release the parking brake and/or move the gear selector lever from position **P**, either of which could result in an accident and/or serious personal injury.

Warning!



Getting out of your vehicle with the gear selector lever not fully engaged in position **P** is dangerous. Also, when parked on an incline, position **P** alone may not prevent your vehicle from moving, possibly hitting people or objects.

Always set the parking brake in addition to shifting to position **P** (▷ page 159).

When parked on an incline, turn front wheels towards the road curb.

Switching off headlamps

- ▶ Turn the exterior lamp switch to **0** (▷ page 47).

For more information, see “Lighting” (▷ page 119).

Turning off the engine

- ▶ Place the gear selector lever in position **P**.



Always set the parking brake in addition to shifting to position **P**.

On steep slopes, turn the front wheels towards the curb.

Turning off the engine with the SmartKey

- ▶ Turn the SmartKey in the starter switch (▷ page 31) to position **0** and remove it.

The immobilizer is activated.



The SmartKey can only be removed from the starter switch with the gear selector lever in position **P**.

- ▶ Press the seat belt release button (▷ page 42).

Allow the retractor to completely rewind the seat belt by guiding the latch plate.



With the SmartKey removed and the driver's door open, a warning sounds if the vehicle's exterior lamps are not switched off. ▷▷

Getting started

Parking and locking



Opening a door causes the windows on that side of the car to open slightly. They will return to the up position when the door is closed.

Warning!



To prevent possible personal injury, always keep hands and fingers away from the door openings when closing the doors. Be especially careful when small children are around.

Before closing doors, make sure there is no possibility of someone getting caught in a door during closing.

- ▶ After exiting the vehicle, press the lock button  on the SmartKey (▷ page 30).

All turn signal lamps flash three times. The locking knobs in the doors move down.

Warning!



When leaving the vehicle, always remove the SmartKey from the starter switch and lock your vehicle. Do not leave children unattended in the vehicle, or with access to an unlocked vehicle. Unsupervised use of vehicle may cause an accident and/or serious personal injury.

For more information, see “Locking and unlocking” (▷ page 86).

Turning off the engine with KEYLESS-GO*

- ▶ Place the gear selector lever in **P**.
- ▶ Press the KEYLESS-GO start/stop button to shut off the engine.

With the driver's door closed, the starter switch is now in position **1**. With the driver's door opened, the starter switch is set to position **0**, same as SmartKey removed from starter switch (▷ page 31).

- ▶ Press the seat belt release button (▷ page 42).

Allow the retractor to completely rewind the seat belt by guiding the latch plate.



If you hear a warning signal you have either

- forgotten to switch off the vehicle's exterior lamps before opening the driver's door, or
- tried to turn off the engine while the gear selector lever is not in **P**.

Turn off the lights or place the gear selector lever in **P**.

Warning!



To prevent possible personal injury, always keep hands and fingers away from the door openings when closing the doors. Be especially careful when small children are around.

Before closing doors, make sure there is no possibility of someone getting caught in a door during closing.



Opening a door causes the windows on that side of the car to open slightly. They will return to the up position when the door is closed.

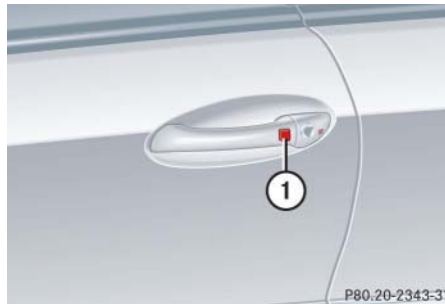

① Lock button on the door handle

- After exiting the vehicle, press lock button ① on the door handle or on the trunk lid.

All turn signal lamps flash three times. The locking knobs in the doors move down.

Getting started

Parking and locking

Warning!



When leaving the vehicle, always remove the SmartKey from the starter switch, take the SmartKey with KEYLESS-GO* with you, and lock your vehicle. Do not leave children unattended in the vehicle, or with access to an unlocked vehicle. Unsupervised use of vehicle equipment may cause an accident and/or serious personal injury.

For more information, see "Locking and unlocking" (▷ page 86).



Safety and Security

Occupant safety

Panic alarm

Driving safety systems

Anti-theft systems



Safety and Security

Occupant safety

▼ Occupant safety

In this section you will learn the most important facts about the restraint systems of the vehicle.

The restraint systems are

- Seat belts
- Emergency tensioning device
- Airbags
- Child seats
- Child seat recognition
- Lower anchors and tethers for children (LATCH)

As independent systems, their protective effects work in conjunction with each other.



For information on infants and children traveling with you in the vehicle and restraint systems for infants and children, see “Children in the vehicle” (▷ page 68).

The **SRS** indicator lamp in the instrument cluster comes on:

- for about 4 seconds when you turn the SmartKey in the starter switch to position **1** or press the KEYLESS-GO* start/stop button once.
- for about 4 seconds when you start the engine by turning the SmartKey or pressing the KEYLESS-GO* start/stop button.



The **SRS** indicator lamp remains lit if the SmartKey is turned to position **2** and left there or if the KEYLESS-GO* start/stop button is pressed twice. The **SRS** indicator lamp will go out when you start the engine.

The **SRS** indicator lamp goes out shortly after you start the engine. This shows that the restraint systems are operational.

A malfunction in the system has been detected if the **SRS** indicator lamp:

- fails to extinguish after approximately 4 seconds.
- does not come on at all.
- comes on after the engine was started or while driving.

For safety reasons, we strongly recommend that you visit an authorized Mercedes-Benz Center immediately to have the system checked.

More information can be found in the “Practical hints” section (▷ page 312).

Warning!



In the event that the **SRS** indicator lamp comes on during driving or does not come at all, the SRS may not be operational. For your safety, we strongly recommend that you visit an authorized Mercedes-Benz Center immediately to have the system checked; otherwise the SRS may not be activated when needed in an accident, which could result in serious or fatal injury, or it might deploy unexpectedly and unnecessarily which could also result in injury.

Improper work on the restraint systems, including incorrect installation and removal, can lead to possible injury through an unintended activation of the SRS.

In addition, through improper work there is a risk of rendering the SRS inoperative or causing unintended airbag deployment. Work on the SRS must therefore only be performed by qualified technicians. Contact your authorized Mercedes-Benz Center.

Airbags

Warning!



Airbags are designed to reduce the potential for injury resulting from certain frontal impacts (front airbags) or side impacts (side impact airbags and head protection window curtain airbags) which may cause significant injuries. However, no system available today can totally eliminate injuries and fatalities.

The activation of the SRS temporarily releases a small amount of dust from the airbags. This dust, however, is neither injurious to your health, nor does it indicate a fire in the vehicle. The dust might cause some temporary breathing difficulty for people with asthma or other breathing trouble. To avoid this, you may wish to get out of the vehicle as soon as it is safe to do so. If you have any breathing difficulty but cannot get out of the vehicle after the airbag inflates, then get fresh air by opening a window or door.

Warning!



To reduce the risk of injury when the front airbags inflate, it is very important for the driver and front passenger to always be in a properly seated position and to be wearing seat belts.

For maximum protection in the event of a collision always be in normal seated position with your back against the backrest. Fasten your seat belt and ensure that it is properly positioned on your body.

Since the airbag inflates with considerable speed and force, a proper seating and hands on steering wheel position will help to keep you at a safe distance from the airbag. Occupants who are unbelted, out of position or too close to the airbag can be seriously injured by an airbag as it inflates with great force in the blink of an eye:

- Sit properly belted in an upright position with your back against the seat backrest.



Safety and Security

Occupant safety



- Adjust the driver seat as far as possible rearward, still permitting proper operation of vehicle controls. The distance from the center of the driver's breastbone to the center of the airbag cover on the steering wheel must be at least ten inches (25 cm) or more. You should be able to accomplish this by a combination of adjustments to the seat and steering wheel. If you have any problems, please see your authorized Mercedes-Benz Center.
- Do not lean with your head or chest close to the steering wheel or dashboard.
- Keep hands on the outside of steering wheel rim. Placing hands and arms inside the rim can increase the risk and potential severity of hand/arm injury when driver front airbag inflates.
- Adjust the front passenger seat as far as possible rearward from the dashboard when the seat is occupied.
- Occupants, especially children, should never lean their heads in the area of the door or the side where the side airbag

inflates. This could result in serious injuries or death should the airbag be triggered. Always sit upright, properly use the seat belts and appropriate size infant or child restraint system.

- Children 12 years old and under must never ride in the front seat, except in a Mercedes-Benz authorized BabySmart^{TM1} compatible child seat, which operates with the BabySmartTM system installed in the vehicle to deactivate the passenger front airbag when it is properly installed. Otherwise they will be struck by the airbag when it inflates in a crash. If this happens, serious or fatal injury will result.

Failure to follow these instructions can result in severe injuries to you or other occupants.

If you sell your vehicle you are responsible to make the buyer aware of these points. Be sure to give the buyer this Operator's Manual.

¹ BabySmartTM is a trademark of Siemens Automotive Corp.

Warning!



Accident research shows that the safest place for children in an automobile is in the rear seat. Should you choose to place a child 12 years old or under in the passenger front seat of your vehicle, you must properly use a BabySmartTM child restraint which will turn off the passenger front airbag. BabySmartTM will not, however, turn off any side impact airbag.

It should be noted that with respect to both front and rear side impact airbags there is a possibility for a side airbag related injury if occupants, especially children, are not properly seated or restrained when next to a side airbag which needs to deploy rapidly in a side impact in order to do its job.

To help avoid the possibility of injury, please follow these guidelines:

- (1) Occupants, especially children, should never place their bodies or lean their heads in the area of the door or the side where the side airbag inflates.

Safety and Security

Occupant safety

This could result in serious injuries or death should the side airbag be activated.

- (2) Always sit upright, properly use the seat belts and use an appropriately sized infant or child restraint system for all children 12 years old or under.
- (3) Always wear seat belts properly.

If you believe that, even with the use of these guidelines, it would be safer for your rear seat occupants to have the rear mounted side airbags deactivated, then deactivation can be accomplished upon your written request to do so at your authorized Mercedes-Benz Center at an additional cost.

Please contact your local authorized Mercedes-Benz Center or call our Customer Assistance Center at 1-800-FOR-MERCEdes (1-800-367-6372) for details.



Airbags are designed to activate only in certain frontal (front airbags) impacts, or side (side impact and head protection window curtain airbags) impacts which exceed preset thresholds.

Only during these types of impacts, if of sufficient severity to meet the deployment thresholds, will they provide their supplemental protection.

The driver and passenger should always wear their seat belts. Otherwise it is not possible for the airbags to provide their supplemental protection.

In cases of other frontal impacts, angled impacts, roll-overs, other side impacts, rear collisions, or other accidents, the airbags will not be activated. The driver and passengers will then be protected by the fastened seat belts.

We caution you not to rely on the presence of the airbags in order to avoid wearing your seat belt.

Your vehicle was originally equipped with airbags that are designed to activate in certain impacts exceeding a preset threshold to reduce the potential and severity of injury. It is important to your safety and that of your passenger that you replace deployed airbags and repair any malfunctioning airbags to ensure that the vehicle will continue to provide supplemental crash protection for occupants.

Safety and Security

Occupant safety

Safety guidelines for the seat belt, emergency tensioning device and airbag

Warning!



- Damaged seat belts or belts that were highly stressed in an accident must be replaced and their anchoring points must also be checked. Only use belts installed or supplied by an authorized Mercedes-Benz Center.
- Airbags and ETDs are designed to function on a one-time-only basis. An airbag or emergency tensioning device (ETD) that was activated must be replaced.
- No modifications of any kind may be made to any components or wiring of the SRS. This includes changing or removing any component or part of the SRS, the installation of additional trim material, badges, etc. over the steering wheel hub, passenger front airbag cover, door trim panels, or rear side

trim panels, and installation of additional electrical/electronic equipment on or near SRS components and wiring. Keep area between airbags and occupants free from objects (e.g. packages, purses, umbrellas, etc.).

- Do not pass belts over sharp edges. They could tear.
- Do not make any modification that could change the effectiveness of the belts.
- Do not hang items such as coat hangers from the coat hooks or handles over the door. These items may turn into projectiles and cause head and other injuries when curtain airbag is deployed.
- An airbag system component within the steering wheel gets hot after the airbag has inflated. Do not touch.
- Improper work on the system, including incorrect installation and removal, can lead to possible injury through an unintended activation of the SRS.

- In addition, through improper work there is a risk of rendering the SRS inoperative or causing unintended airbag deployment. Work on the SRS must therefore only be performed by qualified technicians. Contact your authorized Mercedes-Benz Center.
- For your protection and the protection of others, when disposing of the airbag unit or emergency tensioning device, our safety instructions must be followed. These instructions are available from your authorized Mercedes-Benz Center.
- Given the considerable deployment speed and the textile structure of the airbags, there is the possibility of abrasions or other injuries resulting from airbag deployment.

When you sell your vehicle, we strongly urge you to give notice to the subsequent owner that it is equipped with an SRS by alerting them to the applicable section in the Operator's Manual.

Front airbags

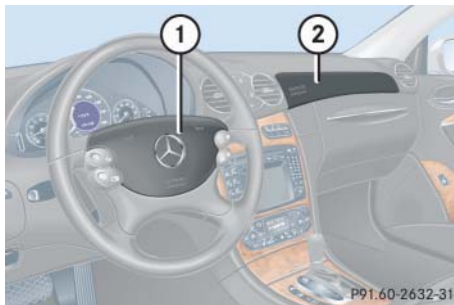

- ① Driver airbag
- ② Passenger airbag

Driver and passenger airbags are deployed:

- in the event of a frontal impact
- if impact exceeds a preset deployment threshold
- independently of the side impact airbags

The airbags will not deploy in impacts which do not exceed the system's deployment thresholds. You will then be protected by the fastened seat belts.

The passenger front airbag will only be deployed if:

- the front passenger seat is occupied.
- the PASS. AIRBAG OFF indicator lamp in the center console is not lit (> page 70).
- impact exceeds a preset deployment threshold



Do not place objects heavier than 20 lbs (9 kg) on the front passenger seat. This could cause the front or side impact airbag on the front passenger side to deploy in a crash which exceeds the system's deployment threshold.

Safety and Security

Occupant safety

Side impact airbags, window curtain airbags

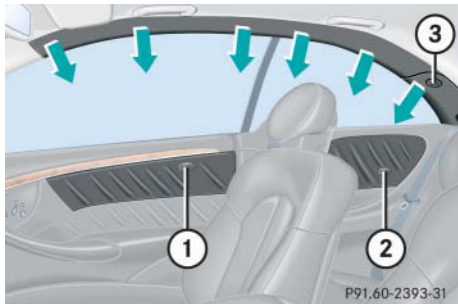

- ① Front side impact airbags
- ② Rear side impact airbags
- ③ Window curtain airbag

The side impact airbags and window curtain airbags are deployed:



- on the impacted side of the vehicle
- in impacts exceeding a preset deployment threshold
- independently of the front airbags

The side impact airbags ① and ② and the window curtain airbags ③ are not deployed in impacts which do not exceed the system's deployment threshold.

The front passenger side impact airbag ① will only deploy if the system senses that the front passenger seat is occupied.

The window curtain airbags ③ fill up the area between the A and C pillars (see arrows).

Seat belts

When the engine is started, the seat belt non-usage warning lamp  illuminates to remind you and your passengers to fasten your seat belts. If the driver's seat belt is not fastened before the engine is started, the seat belt non-usage warning lamp  illuminates and a warning chime sounds for approximately six seconds when the engine is started.

The use of seat belts and infant and child restraint systems is required by law in all 50 states, the District of Columbia, the U.S. territories and all Canadian provinces.

Even where this is not the case, all vehicle occupants should have their seat belts fastened whenever the vehicle is in motion.

Information on fastening seat belts is found in the "Getting started" section (▷ page 40).



For information on infants and children traveling with you in the vehicle and restraint systems for infants and children, see “Children in the vehicle” (▷ page 68).

Warning!



Always fasten your seat belt before driving off. Always make sure your passengers are properly restrained, even those sitting in the rear and pregnant women.

Failure to wear and properly fasten and position your seat belt greatly increases your risk of injuries and their likely severity in an accident. You and your passengers should always wear seat belts.

If you are ever in an accident, your injuries can be considerably more severe without your seat belt properly buckled. Without your seat belt buckled, you are much more likely to hit the interior of the vehicle or be ejected from it. You can be seriously injured or killed.

In the same crash, the possibility of injury or death is lessened if you are properly wearing your seat belt. Airbags can only protect as they are designed if the occupants are properly wearing their seat belts.

Safety and Security

Occupant safety

Warning!



Never ride in a moving vehicle with the seat backrest reclined. Sitting in an excessively reclined position can be dangerous. You could slide under the seat belt in a collision. If you slide under it, the belt would apply force at the abdomen or neck. This could cause serious or even fatal injuries. The seat backrest and seat belt provide the best restraint when the wearer is in an upright position and the belt is properly positioned on the body.

Warning!



Never let more people ride in the vehicle than there are seat belts available. Be sure everyone riding in the vehicle is correctly restrained with a separate seat belt.

Safety and Security

Occupant safety

Warning!



Damaged seat belts or belts that were highly stressed in an accident must be replaced and their anchoring points must also be checked.

Only use seat belts which have been approved by Mercedes-Benz.

Do not make any modifications to the seat belts. This can lead to unintended activation or to failure.

Have all work carried out only by qualified technicians. Contact an authorized Mercedes-Benz Center.

Warning!



USE SEAT BELTS PROPERLY

- Seat belts can only work when used properly. Never wear seat belts in any other way than as described in this section, as that could result in serious injuries in case of an accident.
 - Each occupant should wear their seat belt at all times, because seat belts help reduce the likelihood of and potential severity of injuries in accidents, including rollovers. The integrated restraint system includes SRS (driver airbag, passenger front airbag, side impact airbags, head protection window curtain airbags for side windows), ETD (seat belt emergency tensioning device), and front seat knee bolsters. The system is designed to enhance the protection offered to properly belted occupants in certain frontal (front airbags) and side (side impact and window curtain airbags) impacts which exceed preset deployment thresholds.
- Never wear the shoulder belt under your arm, against your neck or off your shoulder. In a crash, your body would move too far forward. That would increase the chance of head and neck injuries. The belt would also apply too much force to the ribs or abdomen, which could severely injure internal organs such as your liver or spleen.
 - Never wear belts over rigid or breakable objects in or on your clothing, such as eyeglasses, pens, keys, etc., as these might cause injuries.
 - Position the lap belt as low as possible on your hips and not across the abdomen. If the belt is positioned across your abdomen, it could cause serious injuries in a crash.

Safety and Security

Occupant safety

- Never use a seat belt for more than one person at a time. Do not fasten a seat belt around a person and another person or other objects.
- Belts should not be worn twisted. In a crash, you wouldn't have the full width of the belt to manage impact forces. The twisted belt against your body could cause injuries.
- Pregnant women should also use a lap-shoulder belt. The lap belt portion should be positioned as low as possible on the hips to avoid any possible pressure on the abdomen.
- Never place your feet on the instrument panel or on the seat. Always keep both feet on the floor in front of the seat.

Emergency tensioning device (ETD), seat belt force limiter

The seat belts for the front and rear seats are equipped with emergency tensioning devices and belt force limiters.

The ETD is designed to activate in the following cases when the seat belt are fastened and:

- in frontal or rear-end impacts exceeding a preset severity level
- if the restraint systems are operational and functioning correctly. See **SRS** indicator lamp (▷ page 58)

In an impact, emergency tensioning devices remove slack from the belts in such a way that the seat belts fit more snugly against the body. Belt force limiters reduce the force exerted by the seat belts on occupants during a crash.

Warning!



An emergency tensioning device (ETD) that was activated must be replaced.

When disposing of the emergency tensioning device, our safety instructions must be followed. These are available at your authorized Mercedes-Benz Center.



Do not place objects heavier than 20 lbs (9 kg) on the front passenger seat. This could cause the front or side impact airbag on the front passenger side to deploy in a crash which exceeds the system's deployment threshold.

Automatic comfort-fit feature seat belt

An automatic comfort-fit feature for front seats reduces the retracting force of the seat belts when they are in normal use.

Safety and Security

Occupant safety

Children in the vehicle

If an infant or child is traveling with you in the vehicle:

- Secure the child using an infant or child restraint appropriate to the age and size of the child and recommended for use by Mercedes-Benz.
- Ensure that the infant or child is properly secured by a belt at all times while the vehicle is in motion.

Infant and child restraint seats and information on choosing an appropriate restraint system can be obtained from any Mercedes-Benz Center.

Infant and child restraint systems

Only use a BabySmart™¹ compatible child restraint for the front passenger seat in this vehicle.

We recommend all infants and children be properly restrained at all times while the vehicle is in motion.

All lap-shoulder belts except the driver's seat belt have special seat belt retractors for secure fastening of child restraints.

To fasten a child restraint, follow child restraint instructions for mounting. Then pull the shoulder belt out completely and let it retract. During seat belt retraction, a ratcheting sound can be heard to indicate that the special seat belt retractor is activated. The belt is now locked. Push down on child restraint to take up any slack.

To deactivate, release seat belt buckle and let seat belt retract completely. The seat belt can again be used in the usual manner.



Information on child seats with anchor fittings for tether anchorages (▷ page 72).

For information on LATCH-type child seat anchors (▷ page 73).

¹ BabySmart™ is a trademark of Siemens Automotive Corp.

Safety and Security

Occupant safety

Warning!



Never release the seat belt buckle while the vehicle is in motion, since the special seat belt retractor will be deactivated.



The use of infant or child restraints is required by law in all 50 states, the District of Columbia, the U.S. territories, and all Canadian provinces.

Infants and small children should be seated in an appropriate infant or child restraint system properly secured by a lap-shoulder belt or, if so equipped, a child restraint lower anchorage system that complies with U.S. Federal Motor Vehicle Safety Standards 213 and 225 and Canadian Motor Vehicle Safety Standards 213 and 210.2.

A statement by the child restraint manufacturer of compliance with this standard can be found on the instruction label on the restraint and in the instruction manual provided with the restraint.

When using any infant or child restraint system, be sure to carefully read and follow all manufacturer's instructions for installation and use.

Please read and observe warning labels affixed to inside of vehicle and to infant or child restraints.

Warning!



Children 12 years old and under must never ride in the front seat, except in a Mercedes-Benz authorized BabySmartTM¹ compatible child seat, which operates with the BabySmartTM system installed in the vehicle to deactivate the passenger front airbag when it is properly installed. Otherwise they will be struck by the airbag when it inflates in a crash. If this happens, serious or fatal injury will result.

According to accident statistics, children are safer when properly restrained in the rear seating positions than in the front seating positions. Infants and small children must ride in back seats and be seated in an appropriate infant or child restraint system, which is properly secured with the vehicle's seat belt and top tether strap, or secured via lower anchors and top tether strap, fully in accordance with the child seat manufacturer's instructions. >>

¹ BabySmartTM is a trademark of Siemens Automotive Corp.

Safety and Security

Occupant safety



Infants and small children should never share a seat belt with another occupant. During an accident, they could be crushed between the occupant and seat belt.

Children too big for child restraint systems must ride in back seats using regular seat belts. Position shoulder belt across chest and shoulder, not face or neck. A booster seat may be necessary to achieve proper belt positioning for children from 41 lbs until they reach a height where a lap/shoulder belt fits properly without a booster.

A child's risk of serious or fatal injuries is significantly increased if the child restraints are not properly secured in the vehicle and the child is not properly secured in the child restraint.

When the child restraint is not in use, remove it from the vehicle or secure it with the seat belt to prevent the child restraint from becoming a projectile in the event of an accident.

Do not leave children unattended in the vehicle; even if the children are secured in a child restraint system. Unsupervised children in a child restraint system may use vehicle equipment and may cause an accident and/or serious personal injury.

BabySmart™¹ airbag deactivation system



① Indicator lamp

Special BabySmart™ compatible child seats, designed for use with the Mercedes-Benz system and available at any authorized Mercedes-Benz Center, are required for use with the BabySmart™ airbag deactivation system. With the special child seat properly installed, the passenger front airbag will not deploy.

The PASS. AIRBAG OFF indicator lamp ① located in the center console will be illuminated, except with the SmartKey removed or in starter switch position 0.



The system does not deactivate the side impact airbag, the window curtain airbag and the emergency tensioning device.

¹ BabySmart™ is a trademark of Siemens Automotive Corp.

Self-test BabySmart^{TM1} without special child seat installed

After turning the SmartKey in the starter switch to position **1** or **2** or pressing the KEYLESS-GO* start/stop button once or twice, the PASS. AIRBAG OFF indicator lamp ① located in the center console comes on for approximately six seconds and then goes out.

If the indicator lamp should not come on or is continuously lit, the system is not functioning. You must see an authorized Mercedes-Benz Center before seating any child on the passenger seat.

More information can be found in the "Practical hints" section (▷ page 313).

Warning!



The BabySmartTM airbag deactivation system will ONLY work with a special child seat designed to operate with it. It will not work with child seats which are not BabySmartTM compatible.

Never place anything between seat cushion and child seat (e.g. pillow), since it reduces the effectiveness of the deactivation system. The bottom of the child seat must make full contact with the passenger seat cushion. An incorrectly mounted child seat could cause injuries to the child in case of an accident, instead of protecting the child.

Follow the manufacturer's instructions for installation of special child seats.

Warning!



When using a BabySmartTM compatible child seat on the front passenger seat, the passenger front airbag will not deploy only if the PASS. AIRBAG OFF indicator lamp remains illuminated.

Please be sure to check the indicator every time you use the special system child seat. Should the light go out while the restraint is installed, please check installation. If the light remains out, do not use the BabySmartTM restraint to transport children on the front passenger seat until the system has been repaired.

¹ BabySmartTM is a trademark of Siemens Automotive Corp.

Safety and Security

Occupant safety

Warning!



Do not place powered-on laptops, cell phones and like electronic devices on the front passenger seat. Signals from such devices may interfere with the BabySmart^{TM1} system. Such signal interference may cause the PASS. AIRBAG OFF indicator lamp not to come on during self-test or be continuously lit, indicating that the system is not functioning.

¹ BabySmartTM is a trademark of Siemens Automotive Corp.

Installation of infant and child restraint systems

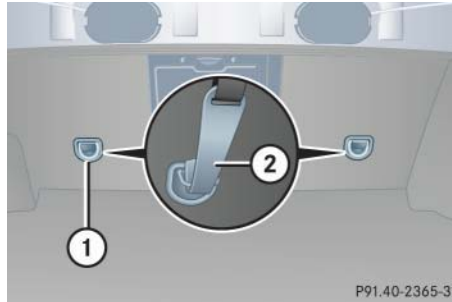

- ① Anchorage ring
- ② Hook

Anchorage rings ① are located on the rear side of outer rear backrests.

Prior to installing a tether strap, note the following steps:

- ▶ Open the trunk and release the backrest.
- ▶ Fold backrest forward.

- ▶ Guide top tether strap between head restraint and top of seat back.

Head restraint must be installed and positioned such that the top tether strap can pass freely between the head restraint and the top of seat back.

Make sure the tether strap is not twisted.

- ▶ Fold backrest back until it locks in place.

Warning!



Always lock backrest in its upright position when rear seat bench is occupied by passengers, or the extended cargo area is not in use. Check for secure locking by pushing and pulling on the backrest.

Safety and Security

Occupant safety

- ▶ Fold up anchorage ring ①.

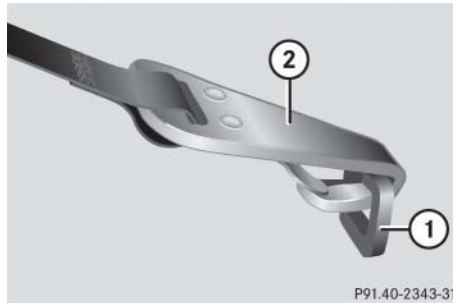

- ① Anchorage ring
- ② Hook

- ▶ Securely fasten hook ②, which is part of the tether strap, to anchorage ring ①.



For safety, please make sure the hook has attached to the ring beyond the safety catch, as illustrated.

Child seat anchors – LATCH type

This vehicle is equipped with two LATCH (Lower Anchors and Tethers for Children) type anchors (at each of the rear seats) for the installation of a LATCH child seat with matching anchor fittings.

If child seats are not installed, the LATCH anchors can be folded back between the seat cushion and the seat backrest.

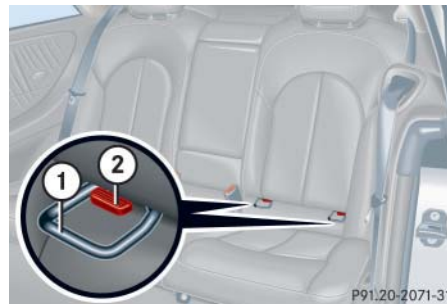

- ▶ Grip inner side of anchors ① and fold forward until they audibly lock in place.
- ▶ Install child seat according to the manufacturer's instructions.



The child seat must be firmly attached in the right and left side anchors.

To fold anchors back

- ▶ Press down button ② on each anchor and return the anchor to its catch.



Non-LATCH type child seats may also be used and can be installed using the vehicle's seat belt system. Install child seat according to the manufacturer's instructions.

Warning!



Children too big for child restraint systems must ride in back seats using regular seat belts. Position shoulder belt across chest and shoulder, not face or neck. A booster seat may be necessary to achieve proper



Safety and Security

Occupant safety

- ▷▷ belt positioning for children from 41 lbs until they reach a height where a lap/shoulder belt fits properly without a booster.
- Before installing the child seat, make sure anchors ① are folded out and locked in place.
- Install child seat according to manufacturer's instructions.
- The child seat must be firmly attached in the right and left side anchor ①.
- An incorrectly mounted child seat may come loose during an accident which could result in serious injury or death to your child.
- Damaged or impact damaged child seats or child seat anchor fittings must be replaced.
- Do not leave children unattended in the vehicle, even if the children are secured in a child restraint system.

Blocking of rear side window operation

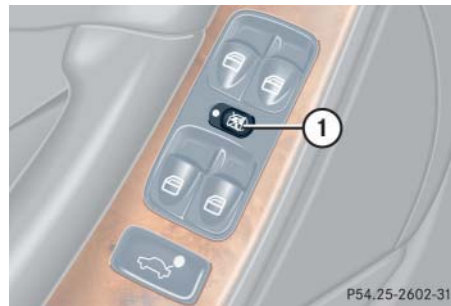

- ① Override switch
- ▶ Slide override switch ① to the right.
- The rear side windows can no longer be operated using the switches located in the rear trim panel.



Operation of the rear side windows with the switches located in the driver's door is still possible.

Warning!



Activate the override switch when children are riding in the back seats of the vehicle. The children may otherwise injure themselves, e.g. by becoming trapped in the window opening.

When leaving the vehicle, always remove the SmartKey from the starter switch take the SmartKey with KEYLESS-GO* with you and lock your vehicle. Do not leave children unattended in the vehicle, or with access to an unlocked vehicle. Unsupervised use of vehicle equipment can cause an accident and/or serious personal injury.

▼ Panic alarm

An audible alarm and flashing exterior lamps will operate for approximately 2½ minutes.



① PANIC button

Activating

- ▶ Press and hold button ① for at least one second.

Deactivating

- ▶ Press button ① again
- or
- ▶ Insert SmartKey in starter switch.

i

For operation in the USA only: This device complies with Part 15 of the FCC Rules. Operation is subject to the following two conditions:

- (1) This device may not cause harmful interference, and
- (2) this device must accept any interference received, including interference that may cause undesired operation.

Any unauthorized modification to this device could void the user's authority to operate the equipment.

Safety and Security

Driving safety systems

▼ Driving safety systems

In this section you will find information on the following driving safety systems:

- ABS (Antilock Brake System)
- BAS (Brake Assist System)
- ESP (Electronic Stability Program)



In winter operation, the maximum effectiveness of the ABS, the BAS, and the ESP is only achieved with winter tires (M+S tires) or snow chains as required.

Warning!



The following factors increase the risk of accidents:

- Excessive speed, especially in turns
- Wet and slippery road surfaces
- Following another vehicle too closely

The ABS, BAS, and ESP cannot reduce this risk.

Always adjust your driving style to the prevailing road and weather conditions.

ABS

Warning!



Do not pump the brake pedal. Use firm, steady brake pedal pressure instead. Pumping the brake pedal defeats the purpose of the ABS and significantly reduces braking effectiveness.

The Antilock Brake System (ABS) regulates the brake pressure so that the wheels do not lock during braking. This allows you to maintain the ability to steer your vehicle.

The ABS is functional above a speed of approximately 5 mph (8 km/h) independent of road surface conditions.

On slippery road surfaces, the ABS will respond even with light brake pressure.

The  indicator lamp in the instrument cluster (▷ page 22) comes on when you turn the SmartKey in the starter switch to position **2** or press the KEYLESS-GO* start/stop button twice. It goes out when the engine is running.

Braking

At the instant one of the wheels is about to lock up, a slight pulsation can be felt in the brake pedal, indicating that the ABS is in the regulating mode.

- ▶ Keep firm and steady pressure on the brake pedal while experiencing the pulsation.

Continuous, steady brake pedal pressure yields the advantages provided by the ABS, namely braking power and the ability to steer the vehicle.

The pulsating brake pedal can be an indication of hazardous road conditions and functions as a reminder to take extra care while driving.

Emergency brake maneuver

- ▶ Keep continuous full pressure on the brake pedal.

Warning!



The ABS cannot prevent the natural laws of physics from acting on the vehicle, nor can it increase braking or steering efficiency beyond that afforded by the condition of the vehicle brakes and tires or the traction. The ABS cannot prevent accidents, including those resulting from excessive speed in turns, following another vehicle too closely, or hydroplaning. Only a safe, attentive, and skillful driver can prevent accidents. The capabilities of an ABS equipped vehicle must never be exploited in a reckless or dangerous manner which could jeopardize the user's safety or the safety of others.

For more information, see “Practical hints” (▷ page 305).

BAS

The Brake Assist System (BAS) operates in emergency situations. If you apply the brakes very quickly, the BAS automatically provides full brake boost, thereby potentially reducing the braking distance. Apply continuous full braking pressure until the emergency braking situation is over. The ABS will prevent the wheels from locking.

When you release the brake pedal, the brakes function again as normal. The BAS is then deactivated.

For more information, see “Practical hints” (▷ page 305).

Safety and Security

Driving safety systems

Warning!





The BAS cannot prevent the natural laws of physics from acting on the vehicle, nor can it increase braking efficiency beyond that afforded by the condition of the vehicle brakes and tires or the traction. The BAS cannot prevent accidents, including those resulting from excessive speed in turns, following another vehicle too closely, or hydroplaning. Only a safe, attentive, and skillful driver can prevent accidents. The capabilities of a BAS equipped vehicle must never be exploited in a reckless or dangerous manner which could jeopardize the user's safety or the safety of others.

ESP

The Electronic Stability Program (ESP) monitors the vehicle's traction (force of adhesive friction between the tires and the road surface) and handling.

The ESP recognizes when a wheel is spinning or if the vehicle starts to skid. By applying brakes to the appropriate wheel and by limiting engine output, the ESP works to stabilize the vehicle. The ESP is especially useful while driving off and on wet or slippery road surfaces.

The ESP warning lamp  in the instrument cluster flashes when the ESP is engaged.

The warning lamp  in the instrument cluster comes on when you turn the SmartKey in the starter switch to position **2** or press the KEYLESS-GO* start/stop button twice. It goes out when the engine is running.

Warning!



Never switch off the ESP when you see the ESP warning lamp  flashing in the instrument cluster. In this case, proceed as follows:

- While driving off, apply as little throttle as possible.
- While driving, ease upon the accelerator.
- Adapt your speed and driving style to the prevailing road conditions.

Failure to observe these guidelines could cause the vehicle to skid.

The ESP cannot prevent accidents resulting from excessive speed.

Warning!



The ESP cannot prevent the natural laws of physics from acting on the vehicle, nor can it increase the traction afforded. The ESP cannot prevent accidents, including those resulting from excessive speed in turns or hydroplaning. Only a safe, attentive, and skillful driver can prevent accidents. The capabilities of an ESP equipped vehicle must never be exploited in a reckless or dangerous manner which could jeopardize the user's safety or the safety of others.



Distronic* is switched off when ESP is activated.



Because of the ESP's automatic operation, the engine must be shut off (SmartKey in starter switch position **0** or **1** or KEYLESS-GO* start/stop button in position **0** or **1**) when

- the parking brake is being tested on a brake test dynamometer
- the vehicle is being towed with the front axle raised

Active braking action through the ESP may otherwise seriously damage the brake system.

The ESP will only function properly if you use wheels of the recommended tire size.

For more information, see "Practical hints" (▷ page 305).

Switching off the ESP

Warning!



The ESP should not be switched off during normal driving other than in the circumstances described below. Disabling of the system will reduce vehicle stability in standard driving maneuvers.

To improve the vehicle's traction, turn off the ESP in driving situations where it would be advantageous to have the drive wheels spin and thus cut into surfaces for better grip such as:

- starting out on slippery surfaces and in deep snow in conjunction with snow chains
- sand or gravel

The switch is located on the center console.

Safety and Security

Driving safety systems



- ① ESP off
- ② ESP on

- ▶ Press upper half ① of the ESP switch until the ESP warning lamp  in the instrument cluster comes on.

The ESP is deactivated.

If one or more drive wheels are spinning, the ESP warning lamp  in the instrument cluster flashes, regardless of the speed.

Traction control brakes a spinning wheel even when the ESP is deactivated.

The ESP always operates when you are braking, even when it has been deactivated.



Avoid spinning of a drive wheel for an extended period with the ESP switched off. This may cause serious damage to the drivetrain which is not covered by the Mercedes-Benz Limited Warranty.

Warning!



When the ESP warning lamp  is illuminated continuously, the ESP is switched off.

Adapt your speed and driving to the prevailing road conditions and to the non-operating status of the ESP.

Switching on the ESP

- ▶ Press lower half ② of the ESP switch until the ESP warning lamp  in the instrument cluster goes out.

You are now again in normal driving mode.

▼ Anti-theft systems

Immobilizer

The immobilizer prevents unauthorized persons from starting your vehicle.

Activating

- With the SmartKey: Removing the SmartKey from the starter switch activates the immobilizer.
- With KEYLESS-GO*: Turning off the engine by means of the start/stop button on the gear selector lever activates the immobilizer.

Deactivating

- With the SmartKey: Inserting the SmartKey in the starter switch deactivates the immobilizer.
- With KEYLESS-GO*: Starting the engine by means of the start/stop button on the gear selector lever deactivates the immobilizer.



In case the engine cannot be started (yet the vehicle's battery is charged), the system is not operational. Contact an authorized Mercedes-Benz Center or call 1-800-FOR-MERCEdes (in the USA), or 1-800-387-0100 (in Canada).

Safety and Security

Anti-theft systems

Anti-theft alarm system

Once the alarm system has been armed, a visual and audible alarm is triggered when someone opens

- a door
- the trunk
- the hood.

The alarm will stay on, even if the activating element (a door, for example) is immediately closed.

The alarm system will also be triggered when

- someone attempts to raise the vehicle
- the vehicle is opened with the mechanical key.



If the alarm stays on for more than 20 seconds, an emergency call is initiated automatically by the Tele Aid system (▷ page 251) provided Tele Aid service was subscribed to and properly activated, and that necessary cellular service and GPS coverage are available.

Arming the alarm system

The alarm system is armed after locking the vehicle with the SmartKey or KEYLESS-GO*. The turn signal lamps flash three times to indicate that the alarm system is activated. The indicator lamp in the switch for the tow-away alarm will flash after approximately 30 seconds when the alarm system is completely armed (▷ page 25).



If the turn signal lamps do not flash three times one of the following elements may not be properly closed:

- a door
- the trunk lid

Close the respective element and lock the vehicle again.

Disarming the alarm system

The alarm system is disarmed when you unlock your vehicle with the SmartKey or KEYLESS-GO*. The turn signal lamps flash once to indicate that the alarm system is deactivated



The alarm system will rearm automatically again after approximately 40 seconds if no door was opened.



Canceling the alarm

To cancel the alarm:

With the SmartKey

- ▶ Insert the SmartKey in the starter switch.

or

- ▶ Press the  or  button on the SmartKey.

*With KEYLESS-GO**

- ▶ Grasp the outside door handle.

or

- ▶ Press the KEYLESS-GO start/stop button.

Tow-away alarm

Once the tow-away alarm is armed, a visual and audible alarm will be triggered when someone attempts to raise the vehicle.



The tow-away protection alarm is triggered, for example, if the vehicle is lifted on one side.

If the alarm stays on for more than 20 seconds, an emergency call is initiated automatically by the Tele Aid system (> page 251) provided Tele Aid service was subscribed to and properly activated, and that necessary cellular service and GPS coverage are available.

Arming tow-away alarm

When you lock your vehicle, the tow-away alarm is automatically armed after about 30 seconds.

When you unlock your vehicle, the tow-away protection disarms automatically.

Safety and Security

Anti-theft systems

Disarming tow-away alarm

To prevent triggering the tow-away alarm feature, switch off the tow-away alarm before towing the vehicle, or when parking on a surface subject to movement, such as a ferry or auto train.

The switch is located on the center console.

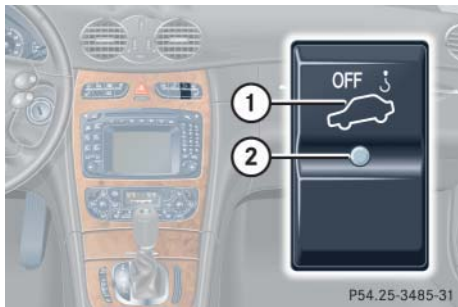

① Tow-away alarm off switch

② Indicator lamp

- ▶ Turn off the ignition and remove the SmartKey.



You cannot disarm the tow-away alarm while the ignition is turned on.



- ▶ Press upper half ① of the switch. Indicator lamp ② in the switch comes on briefly.
- ▶ Exit and lock your vehicle with the SmartKey or (vehicles with KEYLESS-GO*) the lock button at each door handle.

The tow-away alarm remains disarmed until you lock your vehicle again.

Canceling the alarm

To cancel the alarm:

With the SmartKey

- ▶ Insert the SmartKey in the starter switch.
- or
- ▶ Press the  or  button on the SmartKey.

*With KEYLESS-GO**

- ▶ Grasp the outside door handle.
- or
- ▶ Press the KEYLESS-GO start/stop button.



Controls in detail

Locking and unlocking

Seats

Memory function

Lighting

Instrument cluster

Control system

Automatic transmission

Good visibility

Automatic climate control

Audio system

Power windows

Sliding/pop-up roof*

Driving systems

Loading

Useful features

Controls in detail

Locking and unlocking

In the “Controls in detail” section you will find detailed information on how to operate the equipment installed on your vehicle. If you are already familiar with the basic functions of your vehicle, this section will be of particular interest to you.

To quickly familiarize yourself with the basic functions of the vehicle, refer to the “Getting started” section of this manual. The corresponding page numbers are given at the beginning of each segment.

▼ Locking and unlocking

SmartKeys

Your vehicle comes supplied with two SmartKeys, each with remote control and a removable mechanical key. The locking tabs for the mechanical key portion of the two SmartKeys are a different color to help distinguish each SmartKey unit.

The SmartKey provides an extended operating range. To prevent theft, however, it is advisable to only unlock the vehicle when you are in close proximity to it.





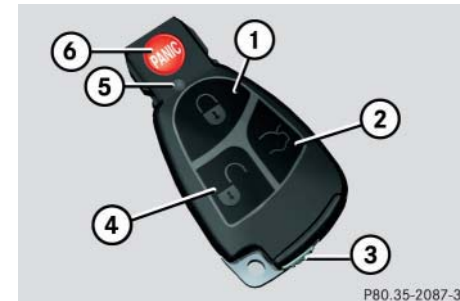

To prevent possible malfunction, avoid exposing the SmartKey to high levels of electromagnetic radiation.

The SmartKey centrally locks and unlocks:

- the doors
- the trunk
- the fuel filler flap



SmartKey with remote controls

- ①  Lock button
- ②  Opening button for trunk lid
- ③ Mechanical key locking tab
- ④  Unlock button
- ⑤ Battery check lamp
- ⑥  PANIC Panic button (▷ page 75)



You can also open and close the power windows (▷ page 212) and sliding/pop-up roof* (▷ page 216) using the SmartKey.

Factory setting

Global unlocking

- ▶ Press button .

All turn signal lamps flash once. The locking knobs in the doors move up.

The vehicle will lock again automatically within approximately 40 seconds of unlocking if neither door nor trunk is opened, the SmartKey is not inserted in the starter switch, or if the central locking switch is not activated.



Global locking

- ▶ Press button .

All turn signal lamps flash three times. The locking knobs in the doors move down.

Selective setting

If you frequently travel alone, you may wish to reprogram the SmartKey so that pressing  only unlocks the driver's door and the fuel filler flap.

- ▶ Press and hold buttons  and  simultaneously for about five seconds until battery check lamp  flashes twice.

The SmartKey will then function as follows:

Unlocking driver's door and fuel filler flap

- ▶ Press button  once.

Global unlocking

- ▶ Press button  twice.



Global locking

- ▶ Press button .

Controls in detail

Locking and unlocking

Restoring to factory setting

- ▶ Press and hold buttons  and  simultaneously for about six seconds until battery check lamp  flashes twice.

Warning!



When leaving the vehicle, always remove the SmartKey from the starter switch, take the SmartKey with KEYLESS-GO* with you and lock the vehicle. Do not leave children unattended in the vehicle, or with access to an unlocked vehicle. It is possible for children to open a locked door from the inside, which could result in an accident and/or serious personal injury.

Controls in detail

Locking and unlocking



If you can no longer lock or unlock the vehicle with the SmartKey, then the batteries in the SmartKey are discharged, the SmartKey is malfunctioning or the vehicle battery is drained.

- Check the batteries in the SmartKey and replace them if necessary (▷ page 345).
- Use the mechanical key to unlock the doors (▷ page 343) and the trunk (▷ page 344).
- Have the vehicle battery and the battery connections checked.
- Use the mechanical key to lock the doors and the trunk (▷ page 344).

If the SmartKey is malfunctioning, contact an authorized Mercedes-Benz Center.

Checking the batteries

- ▶ Press button or .

Battery check lamp comes on briefly to indicate that the SmartKey batteries are in order.



If battery check lamp does not come on briefly during check, then the SmartKey batteries are discharged.

Replace the batteries (▷ page 345).

You can obtain the required batteries at any authorized Mercedes-Benz Center.



If the batteries are checked within signal range of the vehicle, pressing the or button will lock or unlock the vehicle accordingly.

Unlocking and opening the trunk lid

You can unlock and open the trunk lid separately.

A minimum height clearance of 5.71 ft (1.74 m) is required to open the trunk lid.

- ▶ Press and hold button until the trunk lid unlocks and begins to open.



The trunk lid swings open upwards automatically. Always make sure there is sufficient overhead clearance.

Vehicles with trunk lid opening/closing system*: To stop the opening procedure, press button . The Trunk lid stops moving.



If the trunk lid does not open, it is still locked separately (if applicable) (▷ page 104).

If the vehicle was previously centrally locked, the trunk lid will lock automatically when closed (▷ page 97). The turn signals will flash three times to confirm locking.

The trunk can also be opened from its inside in an emergency, see “Trunk lid emergency release” (▷ page 103).

Loss of SmartKey or mechanical key

If you lose a SmartKey or mechanical key, you should do the following:

- ▶ Have the SmartKey deactivated by an authorized Mercedes-Benz Center.
- ▶ Report the loss of the SmartKey or the mechanical key immediately to your car insurance company.
- ▶ If necessary, have the mechanical lock replaced.

Your authorized Mercedes-Benz Center will be glad to supply you with a replacement.

Controls in detail

Locking and unlocking

SmartKey with KEYLESS-GO*

Specially equipped vehicles come with two SmartKeys with KEYLESS-GO, each with remote control and a removable mechanical key. The locking tabs for the mechanical key portion of the two SmartKeys are a different color to help distinguish each SmartKey unit.

The KEYLESS-GO function is integrated into the SmartKey. On these vehicles, the validity of the SmartKey with KEYLESS-GO is checked every time you pull a door handle.



To prevent possible malfunction, avoid exposing the SmartKey with KEYLESS-GO to high levels of electromagnetic radiation.

If the SmartKey with KEYLESS-GO* is valid, your vehicle unlocks

- the doors
- the trunk lid

Controls in detail

Locking and unlocking

- the fuel filler flap

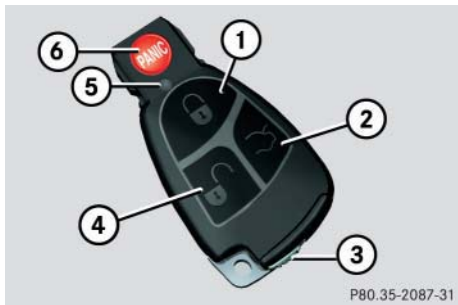

SmartKey with remote controls

- ① Lock button
- ② Opening button for trunk lid
- ③ Mechanical key locking tab
- ④ Unlock button
- ⑤ Battery check lamp
- ⑥ PANIC Panic button (▷ page 75)

For more information on using the SmartKey buttons, see “SmartKeys” (▷ page 86)

Warning!



When leaving the vehicle, always remove the SmartKey from the starter switch, take the SmartKey with KEYLESS-GO with you and lock the vehicle. Do not leave children unattended in the vehicle, or with access to an unlocked vehicle. Unsupervised use of vehicle equipment may cause an accident and/or serious personal injury.



You can also open and close the power windows (▷ page 212) and sliding/pop-up roof* (▷ page 216) using the SmartKey.



If the vehicle has been parked for a longer period of time, you must pull the door handle in order to activate the KEYLESS-GO function.

Important notes on using KEYLESS-GO*

- You can also use the SmartKey with KEYLESS-GO like a normal SmartKey (▷ page 86).
- You can combine KEYLESS-GO functions with normal SmartKey functions (e.g. unlocking with KEYLESS-GO and locking with the remote control).
- Always carry the SmartKey with KEYLESS-GO with you.
- Never store the SmartKey with KEYLESS-GO together with:
 - electronic items such as a cellular phone or another SmartKey with KEYLESS-GO
 - metallic objects such as coins or metal foil

Doing so could impair the function of the KEYLESS-GO system.

Controls in detail

Locking and unlocking

- To lock or unlock the vehicle, the SmartKey with KEYLESS-Go must be located outside the vehicle within approximately 3 ft (1 m) of a door or the trunk.
- In order to start the engine with the SmartKey with KEYLESS-GO:
 - the SmartKey with KEYLESS-GO must be located in the vehicle
 - all the doors must be closed
 - the brake pedal must be depressed
- If you have started the engine with the KEYLESS-GO start/stop button, you can only turn it off again with this button, even if you have put the SmartKey in the starter switch in the meantime.
- This does not apply if, after starting, the gear selector lever is still in position **P**, and the SmartKey is then inserted in the starter switch. The SmartKey will then have priority over the KEYLESS-GO function and the vehicle's electrical system will operate according to the position of the SmartKey in the starter switch, even stopping the engine.
- If the SmartKey with KEYLESS-GO is positioned farther away from the vehicle the system may no longer recognize the SmartKey with KEYLESS-GO. The vehicle cannot be locked or the engine started via the KEYLESS-GO system.
- If the SmartKey with KEYLESS-GO is removed from the vehicle while the ignition is switched on (e.g. if passenger exits the vehicle with the SmartKey with KEYLESS-GO), the message *Key not recognized!* will appear in the multifunction display.

Find the SmartKey with KEYLESS-GO or change its present location immediately (e.g. place it on the front passenger seat or insert it in shirt pocket).
- Remember that the engine can be started by anyone with a SmartKey with KEYLESS-GO that is left inside the vehicle. If you leave the SmartKey with KEYLESS-GO behind when exiting and locking the vehicle, the message *Key recognized in vehicle!* will appear in the multifunction display.

Controls in detail

Locking and unlocking

Factory setting

Global unlocking

- ▶ Pull the door handle.

The vehicle will lock again automatically within approximately 40 seconds of unlocking if neither door nor trunk is opened.



The vehicles could inadvertently be unlocked if the SmartKey with KEYLESS-GO is within 3 ft (1 m) of the vehicle and:

- the door handle is splashed with water, or
- you attempt to clean the door handle.

Global locking

- ▶ Press lock button at door handle (▶ page 55) or trunk lid (▶ page 93).

Selective setting

If you frequently travel alone, you may wish to reprogram the SmartKey with KEYLESS-GO so when you, grasp the driver's door handle only the driver's door and the fuel filler flap unlocks.

- ▶ Press and hold buttons and simultaneously for about five seconds until battery check lamp flashes twice.

The SmartKey with KEYLESS-GO will then function as follows:

Unlocking driver's door and fuel filler flap

- ▶ Grasp the driver's door handle.

Global unlocking

- ▶ Grasp the door handle on the passenger side.

Global locking

- ▶ Press lock button at door handle or trunk lid.

Restoring to factory setting

- ▶ Press and hold buttons and simultaneously for about six seconds until battery check lamp flashes twice.

Warning!



When leaving the vehicle, always remove the SmartKey from the starter switch, take the SmartKey with KEYLESS-GO* with you and lock the vehicle. Do not leave children unattended in the vehicle, or with access to an unlocked vehicle. It is possible for children to open a locked door from the inside, which could result in an accident and/or serious personal injury.



If you can no longer lock or unlock the vehicle with the SmartKey with KEYLESS-GO, then the batteries in the SmartKey are discharged, the SmartKey with KEYLESS-GO is malfunctioning or the vehicle battery is drained.

- Check the batteries in the SmartKey and replace them if necessary (▷ page 345).
- Use the mechanical key to unlock the doors (▷ page 343) and the trunk (▷ page 344).
- Have the vehicle battery and the battery connections checked.
- Use the mechanical key to lock the doors and the trunk (if applicable) (▷ page 344).

If the SmartKey with KEYLESS-GO is malfunctioning, contact an authorized Mercedes-Benz Center.

Locking the vehicle

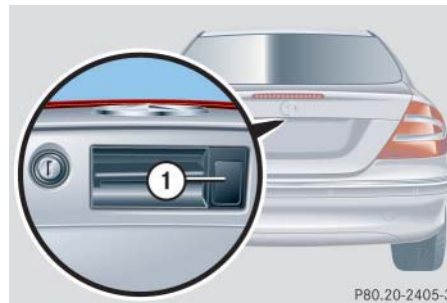

① lock button at trunk

▶ Press the lock button ①.

or

▶ Press the lock button at the driver's door (▷ page 55).

or

▶ Vehicles with trunk lid opening/closing system*, press the KEYLESS-GO locking/closing switch at the trunk lid (▷ page 102).

The vehicle locks. The turn signals blink three times to confirm locking.

Controls in detail

Locking and unlocking

Checking the batteries

▶ Press button or .

Battery check lamp ⑤ comes on briefly to indicate that the SmartKey batteries are in order.



If battery check lamp ⑤ does not come on briefly during check, then the SmartKey batteries are discharged.

Replace the batteries (▷ page 345).

You can obtain the required batteries at any authorized Mercedes-Benz Center.



If the batteries are checked within signal range of the vehicle, pressing the or button will lock or unlock the vehicle accordingly.

Controls in detail

Locking and unlocking

Unlocking and opening the trunk lid

A minimum height clearance of 5.71 ft (1.74 m) is required to open the trunk lid.

The handle is located in the rear license plate recess.

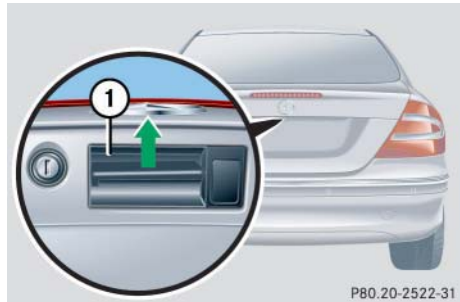

① Handle

- ▶ Pull on handle ①.
The trunk opens.

or

- ▶ Press and hold button  until the trunk unlocks and begins to open.



The trunk lid swings open upwards automatically. Always make sure there is sufficient overhead clearance.

Vehicles with trunk lid opening/closing system*: To stop the opening procedure, press button . The Trunk lid stops moving.



If the trunk lid does not open, it is still locked separately (if applicable) (▷ page 104)

If the vehicle was previously centrally locked, the trunk lid will lock automatically when closed (▷ page 97). The turn signals will flash three times to confirm locking.

The trunk can also be opened from its inside in an emergency, see “Trunk lid emergency release” (▷ page 103).

Closing the side windows and sliding/pop-up roof*

- ▶ Press and hold lock button at door (▷ page 55) until the side windows and the sliding/pop-up roof* are closed.

Warning!



When closing the windows and the sliding/pop-up roof*, make sure there is no danger of anyone being harmed by the closing procedure.

If potential danger exists, proceed as follows:

- Release the lock button.
- Pull on the door handle and hold firmly. The side windows and the sliding/pop-up roof* will open for about two seconds if the door handle is held but the door not opened.

Controls in detail

Locking and unlocking

Loss of the SmartKey with KEYLESS-GO

If you lose your SmartKey with KEYLESS-GO, you should do the following:

- ▶ Have the SmartKey with KEYLESS-GO deactivated by an authorized Mercedes-Benz Center.
- ▶ Report the loss immediately to your car insurance company.
- ▶ Have the mechanical lock replaced if necessary.

Your authorized Mercedes-Benz Center will be glad to supply you with a replacement.

Opening the doors from the inside

You can open a locked door from the inside. Open doors only when conditions are safe to do so.

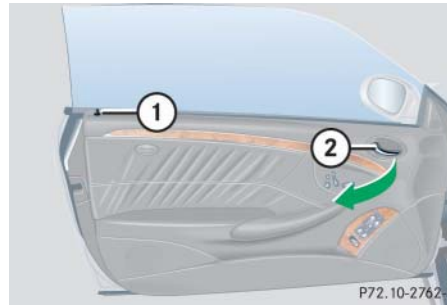

- ① Locking knob
- ② Inside door handle

- ▶ Pull on door handle ②.



If door was locked, locking knob ① will move up.



If the vehicle has previously been locked from the outside with the SmartKey, opening a door from the inside will trigger the anti-theft alarm system.

To cancel the alarm, do one of the following:

With the SmartKey

- Insert the SmartKey in the starter switch.
- Press button  or  on the SmartKey.

With KEYLESS-GO*

- Grasp the outside door handle.
- Press the KEYLESS-GO* start/stop button.

Controls in detail

Locking and unlocking



If you open a door, the side windows on that side of the vehicle will lower slightly. The windows close again when you close the door.

Opening the trunk

Opening the trunk from outside (vehicles without KEYLESS-GO*)

A minimum height clearance of 5.71 ft (1.74 m) is required to open the trunk lid.

The handle is located in the rear license plate recess.

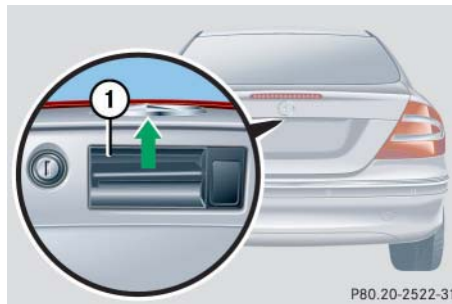

① Handle

► Pull on handle ①.

The trunk opens



The trunk lid swings open upwards automatically. Always make sure there is sufficient overhead clearance.



If the trunk lid does not open, it is still locked separately (if applicable) (▷ page 105).

The vehicle must be unlocked.

The trunk can also be opened using the SmartKey (▷ page 88) or from its inside in an emergency, see “Trunk lid emergency release” (▷ page 103).

Opening the trunk from the inside

You can open the trunk from the inside if the vehicle is stationary.

A minimum height clearance of 5.71 ft (1.74 m) is required to open the trunk lid.

The switch is located on the driver's door.



① Remote trunk lid switch with indicator lamp

- ▶ Press remote trunk lid switch ①.

The trunk lid opens. The indicator lamp in the switch remains lit as long as the trunk is open.



The trunk lid swings open upwards automatically. Always make sure there is sufficient overhead clearance.



If the trunk lid does not open, it is still locked separately (if applicable) (▶ page 104)

If the vehicle was previously centrally locked, the trunk lid will lock automatically when closed (▶ page 97). The turn signals will flash three times to confirm locking.

The trunk can also be opened using the SmartKey (▶ page 88) or from its inside in an emergency, see “Trunk lid emergency release” (▶ page 103).

Controls in detail

Locking and unlocking

Closing the trunk



① Handle

- ▶ Lower trunk lid by pulling firmly on handle ①.
- ▶ Close trunk lid with hands placed flat on it.

Warning!



To prevent possible personal injury, always keep hands and fingers away from the trunk lid opening when closing the trunk. Be especially careful when small children are around.

Controls in detail

Locking and unlocking

Warning!



Only drive with the trunk closed. Among other dangers, such as your view being blocked, exhaust fumes may enter the vehicle interior.



Do not place the SmartKey in the open trunk. You may lock yourself out.



Vehicles with KEYLESS-GO*: To prevent a possible inadvertent lock-out, the trunk lid will open automatically if a SmartKey with KEYLESS-GO* is recognized inside the vehicle or in the trunk.

Trunk lid opening/closing system*

Opening the trunk from the inside

You can open the trunk from the inside if the vehicle is stationary.

A minimum height clearance of 5.71 ft (1.74 m) is required to open the trunk lid.

The switch for opening and closing the trunk is located on the driver's door.



① Remote trunk lid opening switch

② Remote trunk lid closing switch

- ▶ Press remote trunk lid opening switch ① until the trunk lid begins to open.

The trunk lid opens. The indicator lamp in the switch comes on and remains lit until the trunk is closed.



The trunk lid swings open upwards automatically. Always make sure there is sufficient overhead clearance. To stop the opening procedure, press the remote trunk lid opening or closing switch.



If the trunk lid does not open, it is still locked separately (if applicable) (▷ page 104)

If the vehicle was previously centrally locked, the trunk lid will lock automatically when closed (▷ page 97). The turn signals will flash three times to confirm locking.

The trunk can also be opened using the SmartKey (▷ page 88) or from its inside in an emergency, see “Trunk lid emergency release” (▷ page 103).

Limiting opening height of trunk lid

The trunk lid opening height can be limited when transporting goods on a roof rack (e.g. presence of an MB sport luggage container). When activated, the trunk lid opens to approximately the height of the roof edge.

- ▶ With the trunk lid closed, press the remote trunk lid closing switch ② (▷ page 99) and hold for at least five seconds.

Depending on its previous status, the opening height limitation is then switched on or off.

You can activate or deactivate the opening height limitation with the control system, see “Setting trunk lid opening limiter (vehicles with trunk lid opening/closing system*)” (▷ page 149).

Closing the trunk from the inside

- ▶ Press the remote trunk lid closing switch ② (▷ page 98) until the indicator lamp in the switch goes out and the trunk lid is closed.

To interrupt the closing procedure:

- ▶ Release remote trunk lid closing switch ②.

Warning!



Only drive with the trunk closed. Among other dangers, such as your view being blocked, exhaust fumes may enter the vehicle interior.

Controls in detail

Locking and unlocking

Warning!



Maintain sight of trunk area while operating the door mounted switch. Monitor the closing procedure carefully to ensure that no one is in danger of being injured.

To interrupt the closing procedure, release the door mounted remote trunk lid closing switch.

When leaving the vehicle, always remove the SmartKey from the starter switch, take the SmartKey with you and lock your vehicle. Do not leave children unattended in the vehicle, or with access to an unlocked vehicle. Unsupervised use of vehicle equipment may cause an accident and/or serious personal injury.

If the trunk lid comes into contact with an object while closing (e.g. luggage that has been piled too high), the closing procedure is stopped and the trunk reopens slightly.

Controls in detail

Locking and unlocking

Closing the trunk from the outside (vehicles without KEYLESS-GO*)



- ① Trunk lid closing switch
- ▶ Press trunk lid closing switch ① briefly.
- The trunk lid closes.

If the trunk lid comes into contact with an object while closing (e.g. luggage that has been piled too high), the closing procedure is stopped and the trunk reopens slightly.

Warning!



Monitor the closing procedure carefully to ensure that no one is in danger of being injured. To prevent possible personal injury, always keep hands and fingers away from the trunk opening when closing the trunk. Be especially careful when small children are around. To stop the closing procedure, press the remote trunk lid opening or closing switch (on driver's door), the trunk lid closing switch ①, or the  button on the SmartKey.

When leaving the vehicle, always remove the SmartKey from the starter switch, take the SmartKey with you and lock your vehicle. Do not leave children unattended in the vehicle, or with access to an unlocked vehicle. Unsupervised use of vehicle equipment may cause an accident and/or serious personal injury.

Warning!



Only drive with the trunk closed. Among other dangers, such as your view being blocked, exhaust fumes may enter the vehicle interior.



Do not place the SmartKey in the open trunk. You may lock yourself out.

Closing the trunk from the outside (vehicles with KEYLESS-GO*)



① Trunk lid closing switch

- ▶ Make sure you have the SmartKey with KEYLESS-GO with you.
- ▶ Press trunk lid closing switch ① briefly.

The trunk lid closes.

If the trunk lid comes into contact with an object while closing (e.g. luggage that has been piled too high), the closing procedure is stopped and the trunk reopens slightly.



To prevent a possible inadvertent lock-out, the trunk lid will open automatically if a SmartKey with KEYLESS-GO* is recognized inside the vehicle or in the trunk.

Warning!



Only drive with the trunk closed. Among other dangers, such as your view being blocked, exhaust fumes may enter the vehicle interior.

Controls in detail

Locking and unlocking

Warning!



Monitor the closing procedure carefully to ensure that no one is in danger of being injured. To prevent possible personal injury, always keep hands and fingers away from the trunk opening when closing the trunk. Be especially careful when small children are around. To stop the closing procedure, press the remote trunk lid opening or closing switch (on driver's door), the trunk lid closing switch ①, or the  button on the SmartKey with KEYLESS-GO.

When leaving the vehicle, always remove the SmartKey from the starter switch, take the SmartKey with KEYLESS-GO with you and lock your vehicle. Do not leave children unattended in the vehicle, or with access to an unlocked vehicle. Unsupervised use of vehicle equipment may cause an accident and/or serious personal injury.

Controls in detail

Locking and unlocking

Closing the trunk and locking the vehicle from the outside (vehicles with KEYLESS-GO*)



① KEYLESS-GO locking/closing switch

You can close the trunk lid and lock the vehicle simultaneously.

- ▶ Make sure you have the SmartKey with KEYLESS-GO with you.
- ▶ Press switch ① briefly.

The vehicle is locked and the trunk lid closes automatically. The turn signals flash three times to confirm locking.

If the trunk lid comes into contact with an object while closing (e.g. luggage that has been piled too high), the closing procedure is stopped and the trunk reopens slightly.



To prevent a possible inadvertent lock-out, the trunk lid will open automatically if a SmartKey with KEYLESS-GO* is recognized inside the vehicle or in the trunk.

Warning!



Only drive with the trunk closed. Among other dangers, such as your view being blocked, exhaust fumes may enter the vehicle interior.

Warning!



Monitor the closing procedure carefully to ensure that no one is in danger of being injured. To prevent possible personal injury, always keep hands and fingers away from the trunk opening when closing the trunk.

Be especially careful when small children are around. To stop the closing procedure, press the remote trunk lid opening or closing switch (on driver's door), the trunk lid closing switch ①, or the  button on the SmartKey with KEYLESS-GO.

When leaving the vehicle, always remove the SmartKey from the starter switch, take the SmartKey with KEYLESS-GO with you, and lock your vehicle. Do not leave children unattended in the vehicle, or with access to an unlocked vehicle. Unsupervised use of vehicle equipment may cause an accident and/or serious personal injury.

Controls in detail

Locking and unlocking

Trunk lid emergency release

The emergency release button is located on the inside of the trunk lid.



① Emergency release button

Illumination of the emergency release button:

- The button will flash for 30 minutes after opening the trunk.
- The button will flash for 60 minutes after closing the trunk.



The emergency release button does not open the trunk lid if the vehicle battery is discharged or disconnected.

- ▶ Briefly press emergency release button ①.



The trunk unlocks and the trunk lid opens.



The emergency release button unlocks and opens the trunk while the vehicle is standing or driving.



If the emergency release button is pressed and the vehicle was centrally locked, the exterior lamps will flash and the alarm will sound as the trunk lid opens. To cancel the alarm, do one of the following:

- press button  or  on the SmartKey.
 - insert the SmartKey in the starter switch.
- In vehicles with KEYLESS-GO*:
- pull the outside door handle.
 - press the start/stop button.

Controls in detail

Locking and unlocking

Separately locking the trunk

Your vehicle may be equipped with a function permitting the separate locking of the trunk using the mechanical key. If present, this feature can permit you to deny any unauthorized person access to the trunk by locking the trunk separately and leaving the SmartKey less the mechanical key with the vehicle.

To verify the presence of this feature, use the mechanical key to lock the trunk and then attempt to open the trunk by pulling the trunk lid handle after the vehicle has been centrally unlocked with the SmartKey.

The lock is located next to the recessed handle.

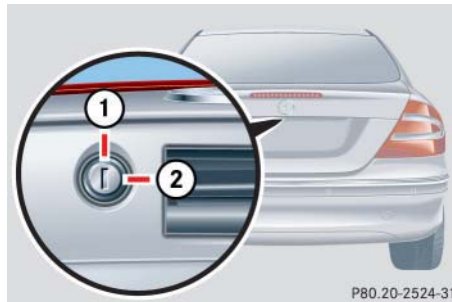

- ① Neutral position
- ② Locked

- ▶ Close the trunk lid (▷ page 97)
- ▶ Pull the mechanical key out of the SmartKey (▷ page 343).
- ▶ Insert the mechanical key in the trunk lid lock.
- ▶ Turn the mechanical key clockwise to position ②.

The trunk remains locked even when the vehicle is centrally unlocked.



You can only cancel the separate trunk locking mode by means of the mechanical key.

Separately unlocking the trunk

- ▶ Pull the mechanical key out of the SmartKey (▷ page 343).
- ▶ Insert the mechanical key in the trunk lid lock.
- ▶ Turn the mechanical key counterclockwise to neutral position ①.

You can now open the trunk (▷ page 96).

A minimum height clearance of 5.71 ft (1.74 m) is required to open the trunk lid.

Warning!



Only drive with the trunk closed. Among other dangers, such as your view being blocked, exhaust fumes may enter the vehicle interior.

Automatic central locking

The doors and the trunk automatically lock when the ignition is switched on and the wheels are turning at vehicle speeds of approximately 9 mph (15 km/h) or more.

You can open a locked door from the inside. Open doors only when conditions are safe to do so.



The doors unlock automatically after an accident if the force of the impact exceeds a preset threshold.

The vehicle automatically locks when the ignition is switched on and the wheels are turning at vehicle speeds of approximately 9 mph (15 km/h) or more. You could therefore lock yourself out when the vehicle

- is pushed or towed
- is on a test stand

You can deactivate the automatic locking using the control system (▷ page 149).

For more information on towing the vehicle, see “Towing the vehicle” (▷ page 368).

Controls in detail

Locking and unlocking

Locking and unlocking from the inside

You can lock or unlock the doors and the trunk from inside using the central locking switch. This can be useful, for example, if you want to lock the vehicle before starting to drive.

The fuel filler flap will not be locked or unlocked with the central locking switch.

Warning!



When leaving the vehicle, always remove the SmartKey from the starter switch, take the SmartKey with KEYLESS-GO* with you and lock the vehicle. Do not leave children unattended in the vehicle, or with access to an unlocked vehicle. Unsupervised use of vehicle equipment may cause an accident and/or serious personal injury.

The switch is located in the center console.



Central locking switch

- ① Locking
- ② Unlocking

Locking

- ▶ Press upper half ① of the central locking switch.

If both doors are closed, the vehicle locks.

Unlocking

- ▶ Press lower half ② of the central locking switch.

The vehicle unlocks.



You can open a locked door from the inside. Open doors only when conditions are safe to do so.

If the vehicle was previously centrally locked with the SmartKey or the SmartKey with KEYLESS-GO*, it will not unlock using the central locking switch.

If the vehicle was previously locked with the central locking switch

- while in the global remote control mode, the vehicle is completely unlocked when a door is opened from the inside.
- while in the selective remote control mode, only the door opened from inside is unlocked.

▼ Seats

Information on seat adjustment can be found in the “Getting started” section (▷ page 34).

Easy-entry/exit feature

With the easy-entry/exit feature activated, the steering wheel tilts upwards and the driver's seat moves to the rear.

This allows easier entry into and exit from the vehicle when the driver's door is opened. However, the engine must be turned off.

When the SmartKey is inserted in the starter switch or you have pressed the KEYLESS-GO* start/stop button once and the driver's door is closed, the steering wheel and the driver's seat return to their last set positions.

Warning!



You must ensure that no one can become trapped or injured by the moving steering wheel and driver's seat when the easy-entry/exit feature is activated, the driver's door is being opened, and the engine is turned off or the SmartKey removed from the starter switch. Do not leave children unattended in the vehicle, or with access to an unlocked vehicle. Children could open the driver's door and unintentionally activate the easy-entry/exit feature, which could result in an accident and/or serious personal injury.

Controls in detail

Seats

You can activate the following functions:

- Steering column:
Only the steering column is adjusted.
- Steering column and seat:
Both the steering column and the seat are adjusted.

The easy-entry/exit feature can be switched on or off in the convenience submenu of the control system (▷ page 150).



To cancel seat /steering wheel movement, do one of the following:

- Press seat adjustment switch (▷ page 34).
- Move the steering column stalk (▷ page 38).
- Press the memory button (▷ page 116)

Controls in detail

Seats

Removing and installing front seat head restraints

Information on head restraint adjustment can be found in the “Getting started” section (▷ page 36).

Warning!



For your protection, drive only with properly positioned head restraints.

Adjust head restraint so that the center of the head restraint supports the back of the head at eye level. This will reduce the potential for injury to the head and neck in the event of an accident or similar situation.

Do not drive the vehicle without the seat head restraints. Head restraints are intended to help reduce injuries during an accident.

Do not interchange head restraints from front and rear seat.



Tilt the seat backrest to the rear for easier removal and installation of the head restraints.

Front seat head restraints

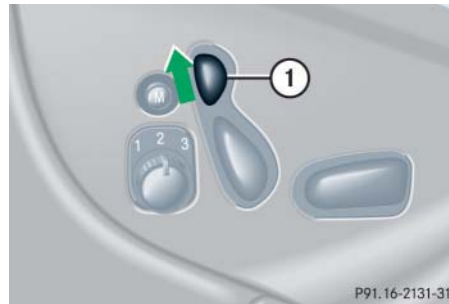

Removing front head restraints

- ▶ Press switch ① upwards and hold until the head restraint is fully extended.
- ▶ Pull out head restraint.

Installing front head restraints:

- ▶ Press switch ① upwards and hold for about five seconds.
- ▶ Push the head restraint down until it engages.
- ▶ Adjust head restraint to desired position (▷ page 36).

Rear seats head restraints

Head restraint height



① Release button

Raising:

- ▶ Manually adjust the height of the head restraint by pulling it upward.

If the head restraint is fully retracted, push release button ① and pull the head restraint out.

Lowering:

- ▶ To lower the head restraint, push release button ① and press down on the head restraint.

Warning!



For your protection, drive only with properly positioned head restraints.

Adjust head restraint so that the center of the head restraint supports the back of the head at eye level. This will reduce the potential for injury to the head and neck in the event of an accident or similar situation.

Do not drive the vehicle without the seat head restraints. Head restraints are intended to help reduce injuries during an accident.

Controls in detail

Seats

Folding head restraints back with release button

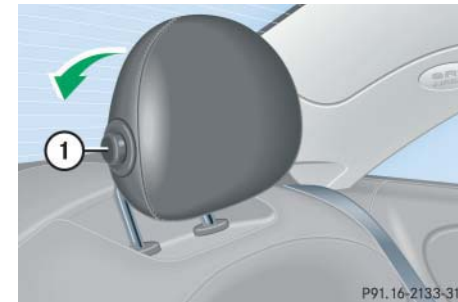

① Release button

- ▶ Push release button ①.

The head restraints will fold backward.



You can also fold the head restraints back using the switch in the center console.

Controls in detail

Seats

Folding head restraints back with switch in the center console



- ① Head restraint release button
 - ▶ Start the engine.
 - ▶ Press the symbol-side on the rocker switch ① to release the head restraints.
- The head restraints will fold backward.

Warning!



For safety reasons, always drive with the rear head restraints in the upright position when the rear seats are occupied.

Keep the area around head restraints clear of articles (e.g. clothing) to not obstruct the folding operation of the head restraints.

Placing rear head restraints upright



- ▶ Pull the rear head restraint forward until it locks into position.



Make sure the head restraints engage when placing them upright. Otherwise their protective function cannot be assured.

Head restraint tilt

Two different head restraint angle positions are available.

- ▶ Press the release button and tilt the head restraint to the desired position.

Removing and installing rear seats head restraints

Warning!



For your protection, drive only with properly positioned head restraints.

Adjust head restraint so that the center of the head restraint supports the back of the head at eye level. This will reduce the potential for injury to the head and neck in the event of an accident or similar situation.

Do not drive the vehicle without the seat head restraints. Head restraints are intended to help reduce injuries during an accident.

Do not interchange head restraints from front and rear seat.



① Release button

Removing rear seat head restraints

- ▶ Fold back head restraint.
- ▶ Pull head restraint to its highest position.
- ▶ Push release button ① and pull out head restraint.

Installing rear head restraints

- ▶ Insert head restraint and push it down until it engages.
- ▶ Push release button ① and adjust head restraint to desired position.

Controls in detail

Seats

Multicontour seat*

The multicontour seat has a movable seat cushion and inflatable air cushions built into the backrest to provide additional lumbar and side support.

The seat cushion movement, backrest cushion height and curvature can be continuously varied with switches on the right side of the seat after starting the engine.

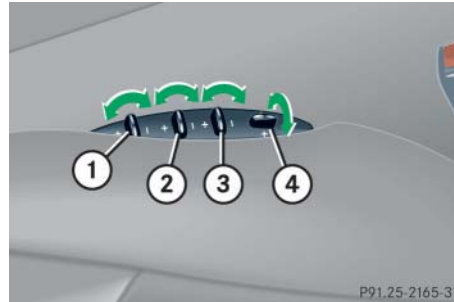

- ① Seat cushion depth
- ② Backrest bottom
- ③ Backrest center
- ④ Side bolster adjustment

- ▶ Start the engine.

Seat cushion depth

- ▶ Adjust the seat cushion depth to the length of your upper leg using switch ①.

Backrest contour

- ▶ Adjust the contour of the backrest to the desired position using switches ② and ③.

Backrest side bolsters

- ▶ Adjust the backrest side bolsters so that they provide good lateral support using switch ④.

Seat ventilation*

Both switches for the front seats are located in the center console.



① Seat ventilation

The blue indicator lamps on the switch show which ventilation level you have selected:

Level	
2	Two indicator lamps on
1	One indicator lamp on
off	No indicator lamp on

- ▶ Make sure the ignition is switched on.

All lamps in the instrument cluster come on.

Switching on seat ventilation

- ▶ Press lower switch position ①.
Two blue indicator lamps on the switch come on.
- ▶ Continue pressing switch ① until the desired seat ventilation level is reached.

Switching off seat ventilation

- ▶ Press lower switch position ① repeatedly until all blue indicator lamps go out.



If one or all of the lamps flash on the seat ventilation switch, there is insufficient voltage due to too many electrical consumers being switched on. The seat ventilation switches off automatically.

The seat ventilation will switch back on again automatically as soon as sufficient voltage is available.

Controls in detail

Seats

Seat heating*

Vehicles without seat ventilation*

Both switches for the front seats are located in the center console.



- ① Normal heating
- ② Rapid heating

- ▶ Make sure the ignition is switched on.
All the lamps in the instrument cluster come on.

Switching on seat heating

- ▶ Press upper switch position ①.

A red indicator lamp on the switch comes on.

Switching off seat heating

- ▶ Press upper switch position ① again.



The seat heating will be automatically switched off after approximately 20 minutes.

Switching on rapid seat heating

- ▶ Press lower switch position ②.

Both red indicator lamps on the switch come on.



The system switches over to normal heating mode after approximately ten minutes. Only one indicator lamp remains lit.

Switching off rapid seat heating

- ▶ Press lower switch position ②.



If one or both of the lamps on the seat heater switch are flashing, there is insufficient voltage available since too many electrical consumers are turned on. The seat heater switches off automatically.

The seat heater will switch back on again automatically as soon as sufficient voltage is available.

Vehicles with seat ventilation*

Both switches for the front seats are located in the center console.



① Seat heating

The red indicator lamps on the switch show the heating level you have selected:

Level	
2	Two indicator lamps on
1	One indicator lamp on
off	No indicator lamp on

- ▶ Make sure the ignition is switched on.

All the lamps in the instrument cluster come on.

Switching on seat heating

- ▶ Press upper switch position ① twice.
A red indicator lamp on the switch comes on.

Switching off seat heating

- ▶ Press upper switch position ① again.



The seat heating will be automatically switched off after approximately 20 minutes.

Switching on rapid seat heating

- ▶ Press upper switch position ① once.
Both red indicator lamps on the switch come on.



The system switches over to normal heating mode after approximately ten minutes. Only one indicator lamp remains lit.

Switching off rapid seat heating mode

- ▶ Press switch position ① twice.



If one or both of the lamps on the seat heating switch are flashing, there is insufficient voltage due to too many electrical consumers are turned on. The seat heating switches off automatically.

The seat heating will switch back on again automatically as soon as sufficient voltage is available.

Controls in detail

Memory function

▼ Memory function



Prior to operating the vehicle, the driver should check and adjust the seat height, seat position fore and aft, and seat backrest angle if necessary, to ensure adequate control, reach and comfort. The head restraint should also be adjusted for proper height. See also the section on airbags (▷ page 59) for proper seat positioning.

In addition, adjust the steering wheel to ensure adequate control, reach, operation and comfort. Both the interior and exterior rear view mirrors should be adjusted for adequate rear vision.

Fasten seat belts. Infants and small children should be seated in a properly secured restraint system that complies with U.S. Federal Motor Vehicle Safety Standards 213 and 225 and Canadian Motor Vehicle Safety Standards 213 and 210.2.

The memory button and stored position switch are located on the door.

You can store up to three different settings for each SmartKey or SmartKey with KEYLESS-GO*.

The following settings are saved for each stored position:

- Driver's seat, backrest and restraint position
- Settings for multicontour seat*
- Steering wheel position
- Driver's side exterior rear view mirror position
- Passenger side exterior rear view mirror position

These key-dependent memory settings can be deactivated if desired (▷ page 151).

Warning!



Do not activate the memory function while driving. Activating the memory function while driving could cause the driver to lose control of the vehicle.

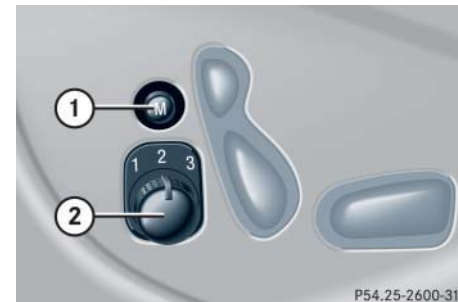

- ① Memory button
- ② Stored position button

- ▶ Make sure the ignition is switched on or the relevant door is open and the SmartKey is inserted in the starter switch.

Controls in detail

Memory function

Storing positions into memory

- ▶ Adjust the seats, steering wheel and rear view mirrors to the desired position (▷ page 34).
- ▶ Turn button ② to selected memory position.
- ▶ Press memory button ①.
- ▶ Release memory button and push button ② within three seconds.

All the settings are stored at the selected position.

Recalling positions from memory

- ▶ Turn button ② to selected memory position.
- ▶ Press and hold button ② until the seat, steering wheel and rear view mirrors have fully moved to the stored positions.



Releasing the button immediately stops movement to the stored positions.

Warning!



Do not operate the power seats using the memory button if the seat backrest is in an excessively reclined position. Doing so could cause damage to front or rear seats. First move the seat backrest to an upright position.

Controls in detail

Memory function

Storing exterior rear view mirror parking position

For easier parking, you can adjust the passenger-side exterior rear view mirror so that you can see the right rear wheel as soon as you engage reverse gear **R**.

For information on activating the parking position feature, see “Setting parking position for exterior rear view mirror” (> page 151).



You can store a parking position for the passenger-side exterior rear view mirror for each SmartKey or SmartKey with KEYLESS-GO*.

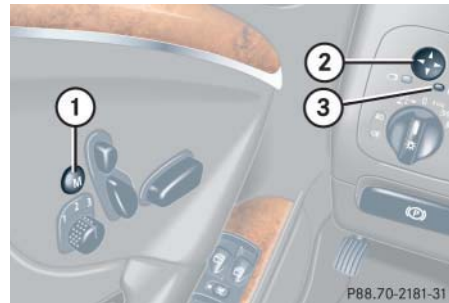

- ① Memory button
- ② Adjustment button
- ③ Passenger-side exterior rear view mirror button

- ▶ Stop the vehicle.
- ▶ Switch on ignition (if not already on).
- ▶ Press button ③.

The passenger-side exterior rear view mirror is selected.

- ▶ Adjust the exterior rear view mirror with button ② so that you see the rear wheel and the road curb.
- ▶ Press memory button ①.
- ▶ Within three seconds, press bottom of adjustment button ②.

The parking position is stored if the mirror does not move.



If the mirror does move, repeat the above steps. After the setting is stored you can move the mirror again.

▼ Lighting

For notes on how to switch on the headlamps and use the turn signals, see “Switching on headlamps” (▷ page 47).



If you drive in countries where vehicles drive on the other side of the road than the country where the vehicle is registered, you must have the headlamps modified for symmetrical low beams. Relevant information can be obtained at your authorized Mercedes-Benz Center



Exterior lamp switch

The exterior lamp switch is located on the dashboard to the left of the steering wheel.



Controls in detail

Lighting

- 0** Off
- AUTO** Automatic headlamp mode
-  Parking lamps (also side marker lamps, tail lamps, license plate lamps, instrument panel lamps)
Canada only:
When engine is running, the low beam is also switched on.
-  Low beam plus parking lamps or high beam headlamps (combination switch pushed forward).
- P** ← → Standing lamps, right (turn left one stop)
- ← P** Standing lamps, left (turn left two stops)

Controls in detail

Lighting



If you remove the SmartKey and open the driver's door while the parking lamps or low beam headlamps are switched on,

- a warning sounds
-  appears in the multifunction display
- the message Turn off lamps! appears in the multifunction display



With the daytime running lamp mode activated and the engine running, the low beam headlamps cannot be switched off manually.

Manual headlamp mode

The low beam headlamps and parking lamps can be switched on and off with the exterior lamp switch. For exterior lamp switch, see “Exterior lamp switch” (▷ page 119).

Automatic headlamp mode

The parking lamps, low beam headlamps and license plate lamps switch on and off automatically depending on the brightness of the ambient light.

- ▶ Turn the exterior lamp switch to **AUTO**.



Warning!



If the exterior lamp switch is set to **AUTO**,

- the headlamps may switch off unexpectedly when the system senses bright ambient light, for example light from oncoming traffic.
- the headlamps will not be automatically switched on under foggy conditions.

To minimize risk to you and to others, activate headlamps by turning exterior lamp switch to  when driving or when traffic and /or ambient lighting conditions require you to do so.

In low ambient lighting conditions, only switch from position **AUTO** to  with the vehicle at a standstill. Switching from **AUTO** to  will briefly switch off the headlamps. Doing so while driving in low ambient lighting conditions may result in an accident.

The automatic headlamp feature is only an aid to the driver. The driver is responsible for the operation of the vehicle's lights at all times.



With the daytime running lamp mode activated, the low beam headlamps will not be switched off automatically.



The front fog lamps and rear fog lamp cannot be switched on manually with exterior lamp switch in position **AUTO**. To activate the fog lamps, turn exterior lamp switch to position and pull the exterior lamp switch to first or second stop (▷ page 122).

Daytime running lamp mode

- ▶ Turn exterior lamp switch to position **0** or **AUTO**.

When the engine is running, the low beam headlamps are automatically switched on. In low ambient light conditions the parking lamps will also switch on.

Canada only

When you shift from a driving position to position **N** or **P**, the low beam switches off (with a three-minute delay).

For nighttime driving you should turn the exterior lamp switch to position to permit activation of the high beam headlamps.

Controls in detail

Lighting

USA only

The high beam headlamps can also be activated when driving with the daytime running lamp mode activated and exterior lamp switch in position **0**.

To activate the daytime running lamp mode, see “Setting daytime running lamp mode (USA only)” (▷ page 145).



See notes on the exterior lamp switch (▷ page 119).

Locator lighting and night security illumination

Locator lighting and night security illumination are described in the control system section, see “Setting locator lighting” (▷ page 146) and see “Setting night security illumination (Exterior lamps delayed shut-off)” (▷ page 147).



Controls in detail

Lighting

Switching on fog lamps

Warning!



In low ambient lighting or foggy conditions, only switch from position **AUTO** to  with the vehicle at a standstill. Switching from **AUTO** to  will briefly switch off the headlamps. Doing so while driving in low ambient lighting conditions may result in an accident.



Fog lamps will operate with the parking lamps and/or the low beam headlamps on. Fog lamps should only be used in conjunction with low beam headlamps. Consult your State or Province Motor Vehicle Regulations regarding permissible lamp operation.



The front fog lamps and rear fog lamp cannot be switched on manually with exterior lamp switch in position **AUTO**. To activate the fog lamps, turn exterior lamp switch to position  and pull the exterior lamp switch to first or second stop (> page 122).

Switching on front fog lamps

- ▶ Make sure the low beam headlamps are switched on.
- ▶ Pull out exterior lamp switch to first stop.

The green indicator lamp  beside the lamp switch comes on.

Switching on rear fog lamp

- ▶ Make sure the low beam headlamps are switched on.
- ▶ Pull out exterior lamp switch to second stop.

The yellow indicator lamp  beside the lamp switch comes on.

Combination switch

The combination switch is located on the left side of the steering column.

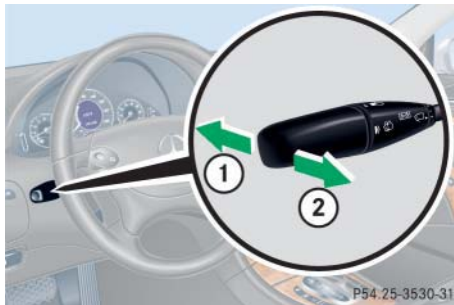

- ① High beam
- ② High beam flasher

Switching on high beams

- ▶ Turn exterior lamp switch to position  or to **AUTO** (▷ page 119).
- ▶ Push the combination switch in direction ①.

The high beam indicator  on the instrument cluster is illuminated (▷ page 22).

High beam flasher

- ▶ Pull the combination switch briefly in direction ②.

Hazard warning flasher

The hazard warning flasher can be activated with the ignition switched on or off. It is activated automatically when an airbag is deployed.

The switch is located on the center console.



- ① Hazard warning flasher switch

Switching on the hazard warning flasher

- ▶ Press the hazard warning flasher switch.

All turn signals will flash.

Controls in detail

Lighting



With the hazard warning flasher activated and the combination switch set for either left or right turn, only the respective left or right turn signal will operate when the SmartKey in the starter switch is in position **1** or **2**.

Switching off the hazard warning flasher

- ▶ Press hazard warning flasher switch again.



If the hazard warning flasher was activated automatically, press switch **①** twice.

Interior lighting

The controls are located in the overhead control panel.



- ① Rear interior lights
- ② Right front reading lamp
- ③ Rocker switch for automatic control system
- ④ Left front reading lamp

Activating automatic control

- ▶ Press rocker switch **③** to center position.

Interior lamps are switched on in darkness, even when you:

- unlock the vehicle
- open a door
- remove the SmartKey from the starter switch

The interior lamps are switched off after a preset time (▶ page 148).



If the door remains open, the interior lamps switch off automatically after approximately five minutes when the SmartKey is removed or in starter switch position **0**.

Deactivating automatic control

- ▶ Press the  symbol on rocker switch ③.

The interior lighting remains switched off in darkness, even when you:

- unlock the vehicle
- open a door
- remove the SmartKey from the starter switch

Manual control

Switching all front interior lights on and off

- ▶ Press the  symbol on rocker switch ③.

The front interior lights come on.

- ▶ Press rocker switch ③ to center position to activate the automatic control.

Switching rear interior lights on and off

- ▶ Press button .

The lights in the rear passenger compartment come on.

- ▶ Press button  again.

The lights in the rear passenger compartment go out.

Switching right front reading lamp on and off

- ▶ Press right button .

The right reading lamp comes on.

- ▶ Press right button  again.

The right reading lamp goes out.

Switching left front reading lamp on and off

- ▶ Press left button .

The left reading lamp comes on.

- ▶ Press left button  again.

The left reading lamp goes out.

Door entry lamps

The appropriate door entry lamp switches on if a door is opened in darkness and if the interior lighting is switched to automatic function.

The entry lamp switches off automatically when the door is closed.



If you turn the SmartKey in the starter switch to position 0 and switch off the exterior headlamps, the door entry lamps will remain lit for approximately five minutes.

Controls in detail

Instrument cluster

▼ Instrument cluster

A full view illustration of the instrument cluster can be found in the “At a glance” section of this manual (▷ page 22).

The instrument cluster is activated when you

- open a door
- turn on the ignition
- press the reset button, see (▷ page 126)
- switch on the exterior lamps

You can change the instrument cluster settings in the Instrument cluster submenu of the control system (▷ page 142).

Instrument cluster illumination



① Reset button

Use the reset button to adjust the illumination brightness for the instrument cluster.



The instrument cluster illumination is dimmed or brightened automatically to suit ambient light conditions.

The instrument cluster illumination will also be adjusted automatically when you switch on the vehicle's exterior lamps.

To brighten illumination

- ▶ Turn reset button ① in the instrument cluster clockwise.

The instrument cluster illumination will brighten.

To dim illumination

- ▶ Turn reset button ① in the instrument cluster counterclockwise.

The instrument cluster illumination will dim.

Coolant temperature indicator

Warning!



- Driving when your engine is badly overheated can cause some fluids which may have leaked into the engine compartment to catch fire. You could be seriously burned.
- Steam from an overheated engine can cause serious burns and can occur just by opening the hood. Stay away from the engine if you see or hear steam coming from it.

Turn off the engine, get out of the vehicle and do not stand near the vehicle until the engine has cooled down.





Excessive coolant temperature triggers a warning in the multifunction display (▷ page 323) and the red coolant warning lamp in the instrument cluster comes on (▷ page 309).

During severe operating conditions, e.g. stop-and-go traffic, the coolant temperature may rise close to 120°C.

The engine should not be operated with the coolant temperature above 120°C. Doing so may cause serious engine damage which is not covered by the Mercedes-Benz Limited Warranty.

Trip odometer

Make sure you are viewing the trip odometer display (▷ page 129).

- ▶ If it is not displayed, press button  or  on the multifunction steering wheel repeatedly until the trip odometer appears.
- ▶ Press and hold reset button ① on the instrument cluster (▷ page 126) until the trip odometer is reset.

Controls in detail

Instrument cluster

Tachometer

The red marking on the tachometer denotes excessive engine speed.



Avoid driving at excessive engine speeds, as it may result in serious engine damage that is not covered by the Mercedes-Benz Limited Warranty.

To help protect the engine, the fuel supply is interrupted if the engine is operated within the red marking.

CLK 55 AMG

The tachometer of the CLK 55 AMG does not have a red marking denoting excessive engine speed.

To help protect the engine, the fuel supply is interrupted if the engine is operated at an excessive engine speed.

Outside temperature indicator

Warning!



The outside temperature indicator is not designed to serve as an ice-warning device and is therefore unsuitable for that purpose.

Indicated temperatures just above the freezing point do not guarantee that the road surface is free of ice. The road may still be icy, especially in wooded areas or on bridges.

The outside temperature is displayed in the multifunction display (▷ page 22). For information on how to select the unit of the displayed temperature, i.e. degrees Celsius (°C) or degrees Fahrenheit (°F), see “Selecting temperature display mode” (▷ page 142)

The temperature sensor is located in the front bumper area. Due to its location, the sensor can be affected by road or engine heat during idling or slow driving. This means that the accuracy of the displayed temperature can only be verified by comparison to a thermometer placed next to the sensor, not by comparison to external displays (e.g. bank signs, etc.).

When moving the vehicle into colder ambient temperatures (e.g. when leaving your garage), you will notice a delay before the lower temperature is displayed.

A delay also occurs when ambient temperatures rise. This prevents inaccurate temperature indications caused by heat radiated from the engine during idling or slow driving.

▼ Control system

The control system is activated as soon as the SmartKey in the starter switch is turned to position **1** or as soon as the KEYLESS-GO* start/stop button is in position **1**. The control system enables you to

- call up information about your vehicle
- change vehicle settings

For example, you can use the control system to find out when your vehicle is next due for service, to set the language for messages in the instrument cluster display, and much more.



The displays for the audio systems (radio, CD player, cassette player) will appear in English, regardless of the language selected.

Warning!



A driver's attention to the road and traffic must always be his/her primary focus when driving.

For your safety and the safety of others, selecting features through the multifunction steering wheel should only be done by the driver when traffic and road conditions permit it to be done safely.

Bear in mind that at a speed of just 30 mph (approximately 50 km/h), your vehicle is covering a distance of 44 feet (approximately 13.5 m) every second.

The control system relays information to the multifunction display.

Controls in detail

Control system

Multifunction display



- ① Outside temperature
- ② Trip odometer
- ③ Automatic transmission program mode
- ④ Main odometer
- ⑤ Current gear selector lever position

Controls in detail

Control system

Multifunction steering wheel

The displays in the multifunction display and the settings in the control system are controlled by the buttons on the multifunction steering wheel (▷ page 24).

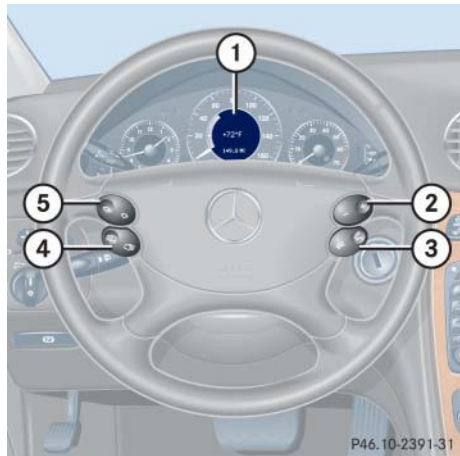

- ① Multifunction display in the speedometer

Operating the control system

- ② Selecting the submenu or setting the volume

— down / to decrease

+ up / to increase

- ③ Telephone*

☎ to take a call

☎ to end a call

- ④ Menu systems

☰ for next menu

☰ for previous menu

- ⑤ Moving within a menu

⬆ for next display





⬇ for previous display

Pressing any of the buttons on the multifunction steering wheel will alter what is shown in the multifunction display.

The information available in the multifunction display is arranged in menus, each containing a number of functions or sub-menus.

The individual functions are then found within the relevant menu (radio or CD operations under *Audio*, for example). These functions serve to call up relevant information or to customize the settings for your vehicle.

It is helpful to think of the menus, and the functions within each menu, as being arranged in a circular pattern.

- If you press button  or  repeatedly, you will pass through each menu one after the other.
- If you press button  or  repeatedly, you will pass through each function display, one after the other, in the current menu.

In the *Settings* menu, instead of functions you will find a number of submenus for calling up and changing settings. For instructions on using these submenus, see “Settings menu” (▷ page 139).

The number of menus available in the system depends on which optional equipment is installed in your vehicle.

The menus are described on the following pages.

Controls in detail

Control system

Menus

This is what you will see when you scroll through the menus.

The table on the next page provides an overview of the individual menus.

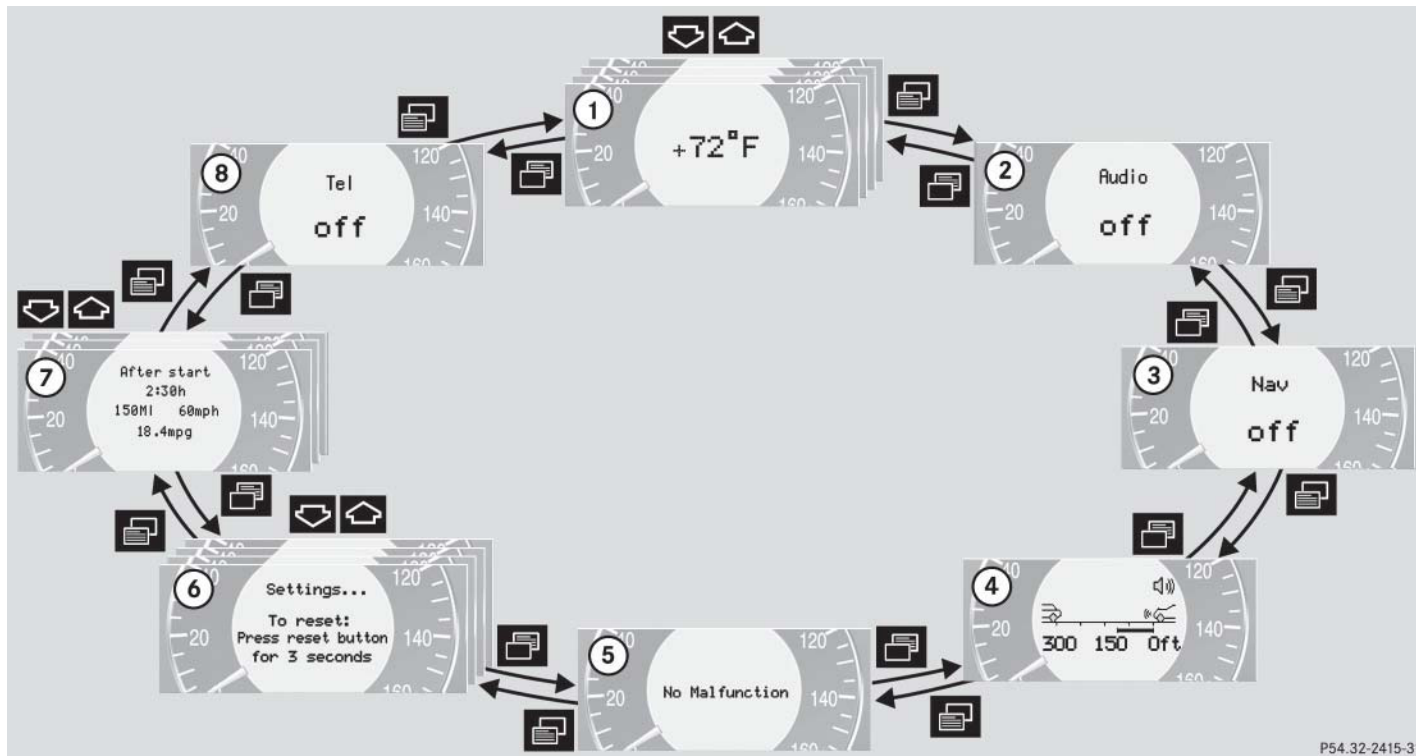

P54.32-2415-31

Menus, submenus and functions

	Menu ①	Menu ②	Menu ③	Menu ④	Menu ⑤	Menu ⑥	Menu ⑦	Menu ⑧
	Standard display	AUDIO	NAVI*	Distronic*	Malfunction memory	Settings	Trip computer	Telephone
Commands/submenus	Digital speedometer	Select radio station	Activate route guidance	Call up settings	Call up malfunction messages	Reset to factory settings	Fuel consumption statistics after start	Load phone book
	Call up FSS	Select satellite radio station				Instrument cluster submenu	Fuel consumption statistics since the last reset	Search for name in phone book
	Check engine oil level	Operate CD player* Operate cassette player				Time submenu Lighting submenu Vehicle submenu Convenience submenu	Call up range	

Controls in detail

Control system



The headings used in the menus table are designed to facilitate navigation within the system and are not necessarily identical to those shown in the control system displays.

The first function displayed in each menu will automatically show you which part of the system you are in.

Standard display menu

You can select the functions in the standard display menu with button or .

The following functions are available:

Function	Page
Call up digital speedometer	134
Call up FSS	297
Check engine oil level	283

Display digital speedometer

- ▶ Press the or button repeatedly until you see the digital speedometer appear in the display.

The current vehicle speed is shown in the multifunction display.

AUDIO menu

The functions in the *Audio* menu operate the audio equipment which you currently have turned on.

If no audio equipment is currently turned on, the message *Audio off* is shown in the display.



The following functions are available:

Function	Page
Select radio station	135
Select satellite radio station*	135
Operate CD player*	136
Operate cassette player	136



Controls in detail

Control system

Select radio station

- ▶ Turn on the radio (▷ page 186). Vehicles with COMAND*: Refer to separate operating instructions.
- ▶ Press button  or  repeatedly until you see the currently tuned station in the display.



- ① Waveband
 - ② Setting for station selection using memory
 - ③ Station frequency
- ▶ Press button  or  repeatedly until the desired station is found.

The type of search depends on the setting for the station tuning (▷ page 148):

- The next stored station is selected (SP)
- Station search



You can only store new stations using the designated feature on the radio (▷ page 191). Vehicles with COMAND*: Refer to separate operating instructions.



You can also operate the radio in the usual manner.

Select satellite radio station*

The Sirius -Satellite - Radio is treated as a radio application.

- ▶ Select SAT radio with the corresponding softkey in the radio menu.



- ① SAT mode and preset number
 - ② Setting for station selection using memory
 - ③ Channel name or number
- ▶ Press button  or  repeatedly until the desired channel is found.

Controls in detail

Control system



Feature description is based on preliminary information available at time of printing.

For more information on satellite radio operation, see “Satellite radio (SAT)* (USA only)” (▷ page 192).

Vehicles with COMAND*: Refer to separate operating instructions.

Operate the CD player*

- ▶ Turn on the radio and select the CD player (▷ page 199). Vehicles with COMAND*: Refer to separate operating instructions.
- ▶ Press button or repeatedly until the settings for the CD currently being played are shown in the display.

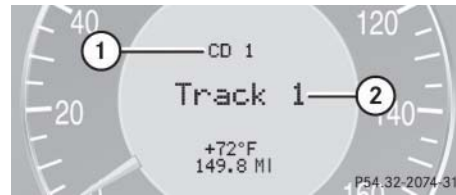

- ① Current CD (for CD changer*)
- ② Current track

- ▶ Press button or repeatedly until the desired track is selected.



To select a CD from the magazine, press a number on the audio system or the COMAND* system key pad located in the center dashboard.

Operate the Cassette player*

- ▶ Turn on the radio and select the cassette player (▷ page 196). Vehicles with COMAND*: Refer to separate operating instructions.
- ▶ Press button or repeatedly until the settings for the cassette currently being played are shown in the display.



- ① Current side

- ▶ Press button to fast forward to the next track.
- ▶ Press button to rewind the cassette to the beginning of the current track.



To select the reverse side of the tape, press button below track number on the audio system display, or enter request on the COMAND* system located in the center dashboard.

NAV menu

The Nav menu contains the functions needed to operate your navigation system.

- ▶ Press button or repeatedly until you see the message Nav in the display.
- If the navigation system is switched off, the message Nav off is shown in the display.
- If the navigation system is on, the message Nav active is shown in the display.

Please refer to the COMAND* manual for instructions on how to activate the route guidance system*.

Distronic* menu

Use the Distronic menu to display the current settings for your Distronic system. What information is shown in the display depends on whether the Distronic system is active or inactive.

Please refer to the “Driving systems” section of this manual (▶ page 221) for instructions on how to activate Distronic.

- ▶ Press button or repeatedly until you see one of the following two pictures in the display.

Distronic deactivated

When Distronic is deactivated you will see the standard display in the display.

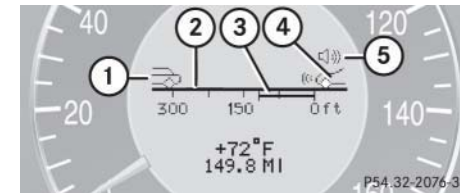

- ① Vehicle ahead, if detected
- ② Actual distance to vehicle ahead
- ③ Preset distance threshold to vehicle ahead
- ④ Your vehicle
- ⑤ Symbol for activated distance warning function

Controls in detail

Control system

Controls in detail

Control system

Distronic activated

When you activate DISTRONIC, you will see the set speed for about five seconds in the DISTRONIC display. The following display then appears:

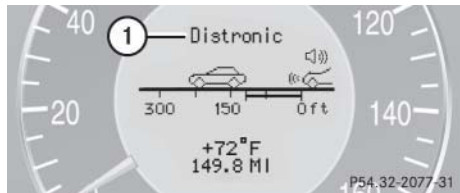

① DISTRONIC activated



Malfunction memory menu

Use the malfunction memory menu to scan malfunction and warning messages that may be stored in the system. What information is shown in the display depends on whether malfunctions have actually occurred.

Warning!



Malfunction and warning messages are only indicated for certain systems and are intentionally not very detailed. The malfunction and warning messages are simply a reminder with respect to the operation of certain systems and do not replace the owner's and/or driver's responsibility to maintain the vehicle's operating safety by having all required maintenance and safety checks performed on the vehicle and by bringing the vehicle to an authorized Mercedes-Benz Center to address the malfunction and warning messages (> page 314).

- ▶ Press button  or  repeatedly until you see the malfunction message memory in the display.

No malfunction messages

If no malfunctions have occurred, the message in the display is:

No Malfunction

Malfunctions have occurred

If malfunctions have occurred, you will see the number of malfunctions in the display:



① Number of malfunctions

- ▶ Press button  or .

The stored messages will now be displayed in order. See the “Practical hints” section for malfunction and warning messages (> page 314).



Should any malfunctions occur while driving, the number of malfunctions will reappear in the display when the SmartKey in the starter switch is turned to position **0** or removed from the starter switch.



The message memory will be cleared when you turn the SmartKey in the starter switch to position **1** or **2**. You will then only see high-priority malfunctions (▷ page 314).

Settings menu

In the Settings menu there are two functions:

- The function `Reset to factory settings?`, with which you can reset all the settings to the original factory settings.
 - A collection of submenus with which you can make individual settings for your vehicle.
- ▶ Press button  or  repeatedly until the Settings menu is seen in the display.



Resetting all settings

You can reset all the functions of all submenus to the factory settings.

- ▶ Press the reset button in the instrument cluster for approximately three seconds.

In the display you will see the request to press the reset button again to confirm.

- ▶ Press the reset button again.

The functions of all the submenus will reset to factory settings.



The settings you have changed will not be reset unless you confirm the action by pressing the reset button a second time. After approximately five seconds, you will see the Settings... menu again.

Controls in detail

Control system

Submenus in the Settings menu



- ▶ Press button  or .



In the display you see the collection of the submenus.





- ▶ Press button .

The selection marker moves to the next submenu.

The submenus are arranged by hierarchy. Scroll down with the  button, scroll up with the  button.

Move within the submenus with the  or  button to the individual functions.

The settings themselves are made with button  or .

Resetting the functions of a submenu

For each submenu you can reset all the functions to the factory settings.

- ▶ Move to a function in the submenu.
- ▶ Press the reset button ( page 126) in the instrument cluster for approximately three seconds.

In the display you will see the request to press the reset button again to confirm.

- ▶ Press the reset button again.

All functions of the submenu will reset to factory settings.

Controls in detail

Control system

The table below shows what settings can be changed within the various menus. Detailed instructions on making individual settings can be found on the following pages.

INSTRUMENT CLUSTER	TIME	LIGHTING	VEHICLE	CONVENIENCE
Select temperature display mode	Set time (hours)	Set daytime running lamp mode (USA only)	Set station selection mode (radio)	Activate easy-entry/exit feature
Select speedometer display mode	Set time (minutes)	Set locator lighting	Set automatic locking	Set key-dependency
Select language		Exterior lamps delayed shut-off	Set opening limiter for trunk lid	Set parking position for exterior rear view mirror
Select display (speed display or outside temperature) for status display		Interior lighting delayed shut-off		
Select display (speed display or outside temperature) for standard display				

Controls in detail



Control system

Instrument cluster submenu

Access the Instr. cluster submenu via the Settings menu. Use the Instr. cluster submenu to change the instrument cluster display settings. The following functions are available:

Function	Page
Select temperature display mode	142
Select speedometer display mode	142
Select language	143
Select display (speed display or outside temperature) for status display	143
Select display (speed display or outside temperature) for standard display	144

Selecting temperature display mode

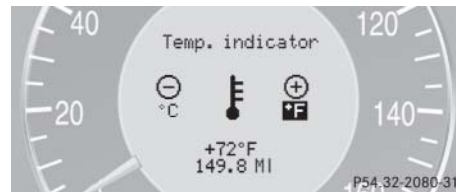

- ▶ Move the selection marker with the **+** or **-** button to the Instr. cluster submenu.
- ▶ Press button  or  repeatedly until you see this message in the display: Temp. indicator.

The selection marker is on the current setting.



- ▶ Press **+** or **-** to set the temperature unit to degrees Celsius (°C) or degrees Fahrenheit (°F).

Selecting speedometer display mode

- ▶ Move the selection marker with the **+** or **-** button to the Instr. cluster submenu.
- ▶ Press button  or  repeatedly until you see this message in the display: Display unit.

The selection marker is on the current setting.



- ▶ Press **+** or **-** to set speedometer unit to km or miles.

Selecting language

- ▶ Move the selection marker with the **+** or **-** button to the Instr. cluster submenu.
- ▶ Press button **▲** or **▼** repeatedly until you see this message in the display: Language.

The selection marker is on the current setting.



- ▶ Press **+** or **-** to select the language to be used for the multifunction display messages.

Available languages:

- German
- English
- French
- Italian
- Spanish

Controls in detail

Control system

Selecting display (speed display or outside temperature) for status indicator

- ▶ Move the selection marker with the **+** or **-** button to the Instr. cluster submenu.
- ▶ Press button **▲** or **▼** repeatedly until you see this message in the display: Status line display.

The selection marker is on the current setting.

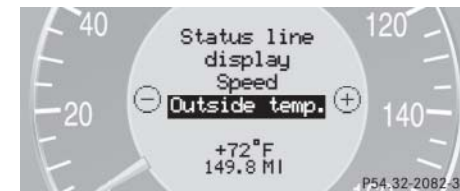

- ▶ Press **+** or **-** to select the status line to degrees Fahrenheit (°F) or miles



You will see the status indicator when you have called up a different display from the standard display.

Controls in detail

Control system

Selecting display (speed display or outside temperature) for standard display

- ▶ Move the selection marker with the **+** or **-** button to the Instr. cluster submenu.
- ▶ Press button **▲** or **▼** repeatedly until you see this message in the display: Basic display.

The selection marker is on the current setting.



- ▶ Press **+** or **-** to select the display permanently shown in the multi-function display.

Time submenu

This function is only available in vehicles with audio system.



Vehicles with COMAND*:
For information on setting the time, refer to the separate COMAND operating instructions.

Access the Time submenu via the Settings menu. Use the Time submenu to change the time display settings. The following functions are available:

Function	Page
Set time (hours)	144
Set time (minutes)	145

Set time (hours)

- ▶ Move the selection marker with the **+** or **-** button to the Time submenu.
- ▶ Press button **▲** or **▼** repeatedly until you see this message in the display: Clock, hours.



The selection marker is on the hour setting.



- ▶ Press **+** or **-** to set the hour.
- ▶ Press the reset button in the instrument cluster to confirm.

The hour is set and stored.

Set time (minutes)

- ▶ Move the selection marker with the **+** or **-** button to the Time submenu.
- ▶ Press button  or  repeatedly until you see this message in the display: Clock, minutes.

The selection marker is on the minute setting.



- ▶ Press **+** or **-** to set the minutes.
- ▶ Press the reset button in the instrument cluster to confirm.



The minutes are set and stored.

Lighting submenu

Access the Lighting submenu via the Settings menu. Use the Lighting submenu to change the lamp and lighting settings on your vehicle. The following functions are available:

Function	Page
Set daytime running lamp mode (USA only)	145
Set locator lighting	146
Exterior lamps delayed switch-off	147
Interior lighting delayed switch-off	148

Setting daytime running lamp mode (USA only)

- ▶ Move the selection marker with the **+** or **-** button to the Lighting submenu.
- ▶ Press button  or  repeatedly until you see this message in the display: Lamp circuit headlamp.

The selection marker is on the current setting.



- ▶ Press **+** or **-** to select manual or daytime running lamp (constant) mode. This function is not available in countries where daytime running lamps are mandatory.

▷▷

Controls in detail

Control system

- ▷▷ With daytime running lamp mode selected and the exterior lamp switch at position **0**, the following lamps will come on automatically when the engine is turned on:
- Parking lamps and low beam headlamps
 - License plate lamps (in low ambient light conditions)



If you turn the exterior lamp switch to another position, the corresponding lamp(s) will switch on.

For safety reasons, resetting the Lighting submenu to factory settings (▷ page 140) while driving will not reset the daytime running lamp mode.

In the display you will then see the message: Lighting - Cannot be completely reset to factory settings while driving.

Setting locator lighting

During darkness, the following lamps will come on when the exterior lamp switch is in position **AUTO**, the locator lighting feature is activated, and the vehicle is unlocked with the SmartKey:

- Parking lamps
- Tail lamps
- License plate lamps
- Front fog lamps

To activate locator lighting:

- ▶ Make sure the function surround lighting is set to on, see (▷ page 146).
- ▶ Turn the exterior lamp switch to position **AUTO**.

The locator lighting switches off when the driver's door is opened. It switches off automatically after a period of approximately 40 seconds.

- ▶ Move the selection marker with the **+** or **-** button to the Lighting submenu.

- ▶ Press button or repeatedly until you see this message in the display: Function Surround lighting.

The selection marker is on the current setting.

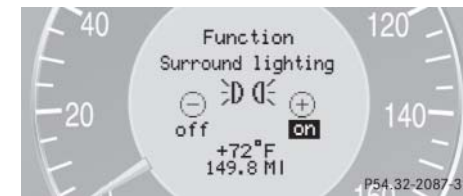

- ▶ Press **+** or **-** to select the desired setting.

The locator lighting will be switched on or off.

Setting night security illumination (Exterior lamps delayed shut-off)

Use the Headlamps delayed shut-off function to set whether and for how long you would like the exterior lamps to illuminate during darkness after all doors are closed. When the delayed shut-off feature is activated and the exterior lamp switch is in position **AUTO**, the following lamps will remain lit after you remove the SmartKey from the starter switch:

- Parking lamps
- Tail lamps
- License plate lamps
- Front fog lamps



You can reactivate this function within ten minutes by opening a door.

If you do not open a door after removing the SmartKey, the lamps will automatically switch off after 60 seconds.

To activate night security illumination:

- ▶ Select delayed shut-off period, see (▷ page 147).
- ▶ Turn the exterior lamp switch to position **AUTO**.

To select delayed shut-off period:

- ▶ Move the selection marker with the **+** or **-** button to the Lighting submenu.
- ▶ Press button or repeatedly until you see this message in the display: Headlamps delayed shut-off.

The selection marker is on the current setting.



- ▶ Press **+** or **-** to select the desired lamp-on period.

Controls in detail

Control system

You can select:

- 0 s, the delayed shut-off feature is deactivated
- 15 s, 30 s, 45 s or 60 s, the delayed shut-off feature is activated

You can temporarily deactivate the delayed shut-off feature:

- ▶ Before leaving the vehicle turn the SmartKey in the starter switch to position **0**.
- ▶ Then turn it to position **2** and back to **0**.

The delayed shut-off feature is deactivated. It will reactivate as soon as you reinsert the SmartKey in the starter switch.

For vehicles with KEYLESS-GO*:

- ▶ Press the KEYLESS-GO start/stop button on the gear selector lever (▷ page 33).

Controls in detail

Control system

Interior lighting delayed shut-off

Use this function to set whether and for how long you would like the interior lighting to remain lit during darkness after the SmartKey is removed from the starter switch.

- ▶ Move the selection marker with the **+** or **-** button to the Lighting submenu.
- ▶ Press button **↕** or **↴** repeatedly until you see this message in the display: Interior lamp delayed shut-off.

The selection marker is on the current setting.



- ▶ Press **+** or **-** to select the desired lamp-on time period. You can select:
 - 0 s, the delayed shut-off feature is deactivated.
 - 5 s, 10 s, 15 s or 20 s, the delayed shut-off feature is activated.

Vehicle submenu

Access the Vehicle submenu via the Settings menu. Use the Vehicle submenu to make general vehicle settings. The following functions are available:

Function	Page
Set station selection mode (radio)	148
Set automatic locking	149
Set opening limiter for trunk lid	149

Setting station selection mode

Use the Audio Search function to select the manual or memory station selection mode for the radio (▷ page 135).

- ▶ Move the selection marker with the **+** or **-** button to the Vehicle submenu.
- ▶ Press button **↕** or **↴** repeatedly until you see this message in the display: Audio Search function.

The selection marker is on the current setting.



- ▶ Press **+** or **-** to select the desired station selection mode. You can select:
 - freq.
 - memory selects next stored station

Setting automatic locking

Use this function to activate or deactivate the automatic central locking. With the automatic central locking system activated, the vehicle is centrally locked at vehicle speeds of approximately 9 mph (15 km/h).

- ▶ Move the selection marker with the **+** or **-** button to the Vehicle submenu.
- ▶ Press button **↕** or **↘** repeatedly until you see this message in the display: Automatic door lock.

The selection marker is on the current setting.



- ▶ Press **+** or **-** to switch Automatic door lock on or off.

Setting trunk lid opening limiter (vehicles with trunk lid opening/closing system*)

Use this function to activate or deactivate the trunk lid opening limiter function. You can also activate or deactivate the opening height limitation with the trunk lid closing switch, see (▷ page 99).

- ▶ Move the selection marker with the **+** or **-** button to the Vehicle submenu.
- ▶ Press button **↕** or **↘** repeatedly until you see this message in the display: Opening limiter Trunk lid.

The selection marker is on the current setting.



- ▶ Press **+** or **-** to switch Opening limiter trunk lid on or off.

Convenience submenu

Access the Convenience submenu via the Settings menu. Use the Convenience submenu to change the settings for a number of convenience features. The following functions are available:

Function	Page
Activate easy-entry/exit feature	150
Set key-dependency	151
Set parking position for exterior rear view mirror	151

Controls in detail

Control system

Activating easy-entry/exit feature

Use this function to activate and deactivate the easy-entry/exit feature. When the feature is activated, the steering wheel and driver's seat will move back to facilitate exiting when you

- remove the SmartKey from the starter switch
- open the driver's door

However, the engine must be turned off.

Warning!



You must make sure no one can become trapped or injured by the moving steering wheel and the driver's seat when the easy-entry/exit feature is in operation and the driver's door is being opened or the SmartKey is removed from the starter switch.

Do not leave children unattended in the vehicle, or with access to an unlocked vehicle. Children could open the driver's door and unintentionally activate the easy-entry/exit feature, which could result in an accident and/or serious personal injury.

After entering the vehicle, the steering wheel and seat will move into the position stored in memory when

- the driver's door is closed.
- you put the SmartKey in the starter switch or press the KEYLESS-GO* start/stop button.
- press the appropriate stored position button on the memory switch (▷ page 116).



To cancel seat/steering wheel movement, do one of the following:

- Press seat adjustment switch (▷ page 35)
- Move the steering column stalk (▷ page 38)
- Press the memory switch (▷ page 116)

- ▶ Move the selection marker with the **+** or **-** button to the Convenience submenu.
- ▶ Press button **↶** or **↷** repeatedly until you see this message in the display: Function Easy-entry feature. The selection marker is on the current setting.



- ▶ Press **+** or **-** to change the easy-entry/exit setting. The following settings are available for the easy-entry/exit feature:

off	The easy-entry/exit feature is deactivated.
Steering col.	Only the steering column is moved.
Steer. col. + seat	Both the steering column and the seat are moved.

Setting key-dependency

Use this function to set whether the memory settings for the seats, the steering wheel and the mirrors should be stored separately for each SmartKey or SmartKey with KEYLESS-GO (▷ page 116).

- ▶ Move the selection marker with the **+** or **-** button to the Convenience submenu.
- ▶ Press button **↶** or **↷** repeatedly until you see this message in the display: Key-dependent. The selection marker is on the current setting.

Controls in detail

Control system

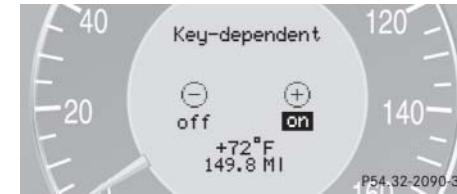



- ▶ Press **+** or **-** to set key-dependency to on or off.

Setting parking position for exterior rear view mirror

Use the Mirror adjustment parking aid function to select whether the passenger-side exterior rear view mirror should be turned downward during parking maneuvers when reverse gear **R** is engaged. For additional information, see “Activating exterior rear view mirror parking position” (▷ page 168).

Controls in detail

Control system

- ▶ Move the selection marker to the Convenience submenu using the **+** or **-** button.
- ▶ Press button  or  repeatedly until you see this message in the display: Mirror adjustment parking aid.

The selection marker is on the current setting.







- ▶ Press **+** or **-** to switch function on or off.

Trip computer menu

Use the trip computer menu to call up statistical data on your vehicle. The following information is available:

Function	Page
Fuel consumption statistics after start	152
Fuel consumption statistics since last reset	153
Call up range (distance to empty)	153

Fuel consumption statistics after start

- ▶ Press button  or  repeatedly until you see the first function of the Trip computer menu.
- ▶ Press button  or  repeatedly until you see this message in the left display: After start.

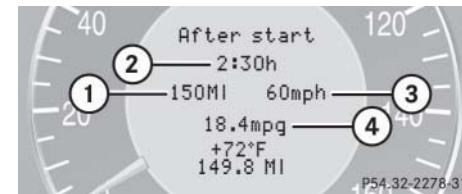

- ① Distance driven since start
- ② Time elapsed since start
- ③ Average speed since start
- ④ Average fuel consumption since start



All statistics stored since the last engine start will be reset approximately four hours after the SmartKey in the starter switch is turned to position **0** or removed from the starter switch.

Resetting will not occur if you turn the SmartKey back to position **1** or **2** within this time period.

Fuel consumption since last reset

- ▶ Press button or repeatedly until you see the first function of the Trip computer menu.
- ▶ Press button or repeatedly until you see this message in the display: After reset.

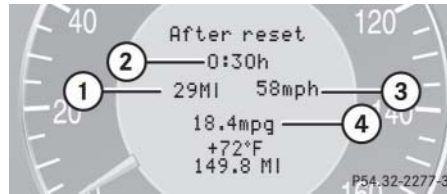

- ① Distance driven since last reset
- ② Time elapsed since last reset
- ③ Average speed since last reset
- ④ Average fuel consumption since last reset

Resetting fuel consumption statistics

- ▶ Press button or repeatedly until you see the first function of the Trip computer menu.
- ▶ Press button or repeatedly until you see the reading that you want to reset in the display.
- ▶ Press and hold the reset button in the instrument cluster (▷ page 126) until the value is reset to 0.

Controls in detail

Control system

Call up range (distance to empty)

- ▶ Press button or repeatedly until you see the first function of the Trip computer menu.
- ▶ Press button or repeatedly until you see this message in the display: Range.

In the display you will see the calculated range based on the current fuel tank level.

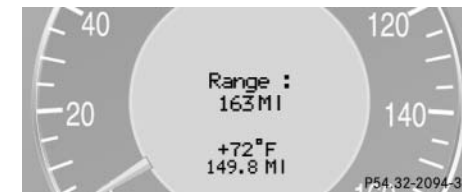

Controls in detail

Control system

TEL menu*

Warning!





A driver's attention to the road must always be his/her primary focus when driving. For your safety and the safety of others, we recommend that you pull over to a safe location and stop before placing or taking a telephone call. If you choose to use the telephone while driving, please use the hands-free device and only use the telephone when weather, road and traffic conditions permit.

Some jurisdictions prohibit the driver from using a cellular telephone while driving a vehicle.

Bear in mind that at a speed of just 30 mph (approximately 50 km/h), your vehicle is covering a distance of approximately 44 feet (approximately 13.5 m) every second.

Never operate radio transmitters equipped with a built-in or attached antenna (i.e. without being connected to an external antenna) from inside the vehicle while the engine is running. Doing so could lead to a malfunction of the vehicle's electronic system, possibly resulting in an accident and/or personal injury.

You can use the functions in the Tel menu to operate your telephone, provided it is connected to a hands-free system and switched on.

- ▶ Switch on the telephone and Audio or COMAND*.
- ▶ Press button  or  on the steering wheel repeatedly until you see the Tel menu in the display.

Which messages will appear in the display field depends on whether your telephone is switched on or off:

- If the telephone is off, the message in the multifunction display is: Tel off.
- If the telephone is on:

The telephone will then search for a network. During this time the display is empty.

As soon as the telephone has found a network, READY is indicated in the display.

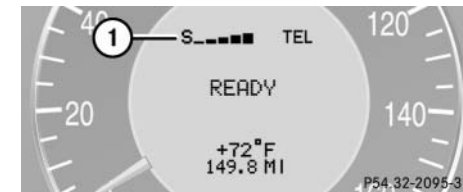

① Signal strength

This standby message indicates that your telephone is ready for use and you can operate it using the control system.



Vehicles with Audio system:
The signal strength is indicated in the top right corner, for example "S9". The higher the number, the stronger the signal from the cellular network.

Vehicles with COMAND*:
The signal strength is indicated by bars in the top left corner. The higher the number of bars, the stronger the signal from the cellular network.

Answering a call

When your telephone is ready to receive calls, you can answer a call at any time. In the display you will then see the message:



- ▶ Press button .

You have answered the call. In the display you see the length of the call.



If you do not wish to accept a call, press button .

Controls in detail

Control system



Ending a call



- ▶ Press button .

You have ended the call. In the display you will again see the standby message.

Dialing a number from the phone book

If your telephone is ready to receive calls, you may select and dial a number from the phone book at any time.

- ▶ Press button  or  repeatedly until you see the Tel menu in the display.



- ▶ Press button  or .

The control system reads the phone book which is stored in the telephone. This may take up to 30 seconds. In the display you will see the message Please wait.

When the message Please wait disappears, the phone book has been loaded. >>



Controls in detail

Control system

- ▷▷▶ Press button  or  repeatedly until the desired name appears in the display.

The stored names are displayed in ascending or descending alphabetical order.



If you press and hold  or  for longer than one second, the system scrolls rapidly through the list of names until you release the button again.

Cancel the quick search mode by pressing .

- ▶ Press button .

The system dials the selected phone number.



- If the connection is successful, the name of the party you called and the duration of the call will appear in the display.



- If no connection is made, the control system stores the dialed number in the redial memory.



Redialing

The control system stores the most recently dialed phone numbers. This eliminates the need to search through your entire phone book.

- ▶ Press button  or  repeatedly until you see the Tel menu in the display.

- ▶ Press button .

In the display you see the first number in the redial memory.

- ▶ Press button  or  repeatedly until the desired name appears in the display.



If you do not want to use the telephone, press button .

- ▶ Press button .

The control system dials the selected phone number.

▼ Automatic transmission

Information on driving with an automatic transmission is found in the “Getting started” section (▷ page 44).

Your vehicle’s transmission adapts its gear shifting process to your individual driving style by continually adjusting the shift points up or down. These shift point adjustments are performed based on current operating and driving conditions.

If the operating conditions change, the automatic transmission reacts by adjusting its gear shift program.



During the brief warm-up, transmission upshifting is delayed. This allows the catalytic converter to heat up more quickly to operating temperature.

The automatic transmission selects individual gears automatically, depending on:

- the gear selector lever position **D** with gear ranges **4, 3, 2, 1** (▷ page 159)
- the selected shift program (**C/S**) (▷ page 163)
or
(C/S/M) (CLK 55 AMG only) (▷ page 164)
- the position of the accelerator pedal (▷ page 163)
- the vehicle speed

The current gear selector lever position and shift program (C/S) or (C/S/M) appear in the multifunction display (▷ page 129).

An additional indication of the current gear selector lever position can be found on the cover of the shifting-gate. The indicators come on when you activate a switch (e.g. unlocking the vehicle or opening a door) and go out after approximately 15 minutes.

Controls in detail

Automatic transmission

Warning!



It is dangerous to shift the gear selector lever out of **P** or **N** if the engine speed is higher than idle speed. If your foot is not firmly on the brake pedal, the vehicle could accelerate quickly forward or reverse. You could lose control of the vehicle and hit someone or something. Only shift into gear when the engine is idling normally and when your right foot is firmly on the brake pedal.

When the gear selector lever is in position **D**, you can influence transmission shifting by

- limiting the gear range
- changing gears manually

Controls in detail

Automatic transmission

One-touch gearshifting

Even with an automatic transmission you can change the gears manually when the gear selector lever is in position **D**.

Downshifting

- ▶ Briefly press the gear selector lever to the left in the **D-** direction.

The transmission will shift from the current gear to the next lower gear. This action simultaneously limits the gear range of the transmission (▷ page 159).

Warning!



On slippery road surfaces, never downshift in order to obtain braking action. This could result in drive wheel slip and reduced vehicle control. Your vehicle's ABS will not prevent this type of loss of control.



To avoid overrevving the engine when the gear selector lever is moved to the **D-** direction, the transmission will not shift to a lower gear if the engine's max. speed would be exceeded.

Upshifting

- ▶ Briefly press the gear selector lever to the right in the **D+** direction.

The transmission will shift from the current gear to the next higher gear as permitted by the shift program. This action simultaneously extends the gear range of the transmission.

Canceling gear range limit

- ▶ Press and hold the gear selector lever in the **D+** direction until **D** reappears in the multifunction display.

The transmission will shift from the current gear range directly to gear range **D**.

Shifting into optimal gear range

- ▶ Press and hold the gear selector lever in the **D-** direction.

The transmission will automatically select the gear range suited for optimal acceleration and deceleration. This will involve shifting down one or more gears.

Gear ranges

With the gear selector lever in position **D**, you can limit the transmission's gear range by pressing the gear selector lever to the left (**D-**), and reverse the gear range limit by pressing the gear selector lever to the right (**D+**).

The selected gear range appears in the multifunction display. If you press on the accelerator when the engine has reached its rpm limit, the transmission will upshift beyond any gear range limit selected.

Effect	
4	The transmission shifts through fourth gear only.
3	The transmission shifts through third gear only. With this selection you can use the braking effect of the engine.

Controls in detail

Automatic transmission

Effect	
2	The transmission shifts through second gear only. Allows the use of engine's braking power when driving: <ul style="list-style-type: none">• on steep downgrades• in mountainous regions• under extreme operating conditions
1	The transmission operates only in first gear. For maximum use of engine's braking effect on very steep or lengthy downgrades.

Controls in detail

Automatic transmission

Gear selector lever position

	Effect
P	Park position Gear selector lever position when the vehicle is parked. Place gear selector lever in position P only when vehicle is stopped. The park position is not intended to serve as a brake when the vehicle is parked. Rather, the driver should always set the parking brake in addition to placing the gear selector lever in position P to secure the vehicle.

	Effect
	The SmartKey can only be removed from the starter switch with the gear selector lever in position P . With the SmartKey removed, the gear selector lever is locked in position P . If the vehicle's electrical system is malfunctioning, the gear selector lever could remain locked in position P (▷ page 347).
R	Reverse gear Place gear selector lever in position R only when vehicle is stopped.

	Effect
N	Neutral No power is transmitted from the engine to the drive axle. When the brakes are released, the vehicle can be moved freely (pushed or towed). To avoid damage to the transmission, never engage N while driving. If the ESP is deactivated or malfunctioning: Move gear selector lever to N only if the vehicle is in danger of skidding, e.g. on icy roads.
D	Drive The transmission shifts automatically. All five forward gears are available.



Coasting the vehicle, or driving for any other reason with gear selector lever in **N** can result in transmission damage that is not covered by the Mercedes-Benz Limited Warranty.

Warning!



Getting out of your vehicle with the gear selector lever not fully engaged in position **P** is dangerous. Also, position **P** alone is not intended to or capable of preventing your vehicle from moving, possibly hitting people or objects.

Always set the parking brake in addition to shifting to position **P** (▷ page 46).

When parked on an incline, turn the front wheels towards the road curb.

Do not park this vehicle in areas where combustible materials such as grass, hay, or leaves can come into contact with the hot exhaust system, as these materials could be ignited and cause a vehicle fire.

Warning!



When leaving the vehicle, always remove the SmartKey from the starter switch, take the SmartKey with KEYLESS-GO* with you and lock the vehicle. Do not leave children unattended in the vehicle, or with access to an unlocked vehicle. Children could move the gear selector lever from position **P**, which could result in an accident and/or serious personal injury.

Controls in detail

Automatic transmission

Steering wheel gearshift control (Speedshift) CLK 55 AMG

In the manual shift program mode you can change the gears manually on the steering wheel or by using the gear selector lever (▷ page 158).

Allow engine to warm up under low load use. Do not place full load on the engine until the operating temperature has been reached. Shift into reverse gear only when the vehicle is stopped.



Avoid spinning of a drive wheel for an extended period when driving off on slippery road surfaces. This may cause serious damage to the drive train which is not covered by the Mercedes-Benz Limited Warranty.

Controls in detail

Automatic transmission

The steering wheel gearshift buttons are located to the left and right of the steering wheel.

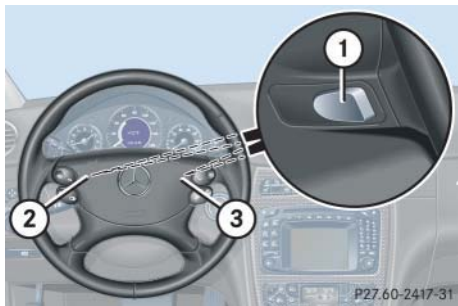

- ① Shift button
- ② Left button: downshift
- ③ Right button: upshift

Downshifting

- ▶ Press button ② on the left side of the steering wheel.

When driving in the manual program mode (▷ page 164), the transmission will shift from the current gear to the next lower gear (▷ page 165).

Warning!



On slippery road surfaces, never downshift in order to obtain braking action. This could result in drive wheel slip and reduced vehicle control. Your vehicle's ABS will not prevent this type of loss of control.



You cannot shift with the steering wheel gearshift buttons when the gear selector lever is in position **P**, **N** or **R**.

Upshifting

- ▶ Press button ③ on the right side of the steering wheel.

When driving in the manual program mode (▷ page 164), the transmission will shift from the current gear to the next higher gear (▷ page 165).



You cannot shift with the steering wheel gearshift buttons when the gear selector lever is in position **P**, **N** or **R**.

Program mode selector switch

The program mode selector switch is located on the lower part of the center console.



① Program mode selector switch

S Sport For standard driving

C Comfort For comfort driving



Never change the program mode when the gear selector lever is out of position **P**. This could result in a change of driving characteristics for which you may not be prepared.

- ▶ Press the program mode selector switch ① repeatedly until the letter of the desired shift program appears in the multifunction display (▷ page 129).

Select **C** for comfort driving:

- The vehicle starts out in second gear (both forward and reverse) for gentler starts. This does not apply if full throttle is applied or gear range **1** is selected.
- Traction and driving stability are improved on icy roads.
- Upshifts occur earlier even when you give more gas. The engine then operates at lower rpms and the wheels are less likely to spin.
- The power transmission ratio for gear selector lever position **R** changes depending on the program mode selected (**S** or **C**).

Accelerator position

Your driving style influences the transmission's shifting behavior:

Less throttle Earlier upshifting

More throttle Later upshifting

Kickdown

Use kickdown when you want maximum acceleration.

- ▶ Press the accelerator past the point of resistance.
The transmission shifts into a lower gear.
- ▶ Ease on the accelerator when you have reached the desired speed.
The transmission shifts up again.

Controls in detail

Automatic transmission

Manual shift program CLK 55 AMG

In the manual shift program mode you can change the gears manually on the steering wheel (▷ page 161) or by using the gear selector lever (▷ page 158).

Allow engine to warm up under low load use. Do not place full load on the engine until the operating temperature has been reached. Shift into reverse gear only when the vehicle is stopped.



Avoid spinning of a drive wheel for an extended period when driving off on slippery road surfaces. This may cause serious damage to the drive train which is not covered by the Mercedes-Benz Limited Warranty.

Program mode selector switch

The program mode selector switch is located on the lower part of the center console.



① Program mode selector switch

- | | |
|------------------|--------------------------|
| S Sport | For standard driving |
| C Comfort | For comfort driving |
| M Manual | For manual gear shifting |

The selected shift program (C/S/M) is indicated in the multifunction display (▷ page 129).

Activating manual shift program

- ▶ Press program mode selector switch ① repeatedly until the **M** for manual shift program appears in the multifunction display.

The program mode switches to manual program mode **M**. Automatic shifting is switched off. The gear range is not limited.

You can change the gears manually when the gear selector lever is in position **D**. You can upshift or downshift through the gears in succession.

The current gear selector lever position and the selected shift program (C/S/M) is indicated in the multifunction display (▷ page 129).

Downshifting

- ▶ Briefly press the gear selector lever to the left in the **D-** direction (▷ page 158).

or

- ▶ Press button ② on the left side of the steering wheel (▷ page 161).
The transmission shifts to the next lower gear.

Warning!



On slippery road surfaces, never downshift in order to obtain braking action. This could result in drive wheel slip and reduced vehicle control. Your vehicle's ABS will not prevent this type of loss of control.

Upshifting

- ▶ Briefly press the gear selector lever to the right in the **D+** direction (▷ page 158).

or

- ▶ Press button ③ on the right side of the steering wheel (▷ page 161).

The transmission shifts to the next higher gear.

Deactivating manual shift program

- ▶ Press the program mode selector switch repeatedly until **S** or **C** appears in the right multifunction display field.

or

- ▶ Restart the engine.

The transmission will go into the last shift program mode selected (**S** or **C**).

Program mode **M** is not stored.



The last selected automatic program mode (**S** or **C**) is switched on when the engine is restarted in the automatic program mode.

Emergency operation (Limp Home Mode)

If vehicle acceleration worsens or the transmission no longer shifts, the transmission is most likely operating in limp home (emergency operation) mode. In this mode, only second gear and reverse gear can be activated.

- ▶ Stop the vehicle.
- ▶ Move gear selector lever to **P**.
- ▶ Turn off the engine.
- ▶ Wait at least ten seconds before restarting.
- ▶ Restart the engine.
- ▶ Move gear selector lever to position **D** (for second gear) or **R**.
- ▶ Have the transmission checked at an authorized Mercedes-Benz Center as soon as possible.

Controls in detail

Good visibility

▼ Good visibility

Windshield wipers

More information on the windshield wipers can be found in the “Getting started” section (▷ page 48).



Intermittent wiping is interrupted when the vehicle is at a standstill and a door is opened.

A rain sensor automatically controls the windshield wipers depending on how wet the windshield is.

- ▶ Switch ignition on.
- ▶ Set the wiper switch to position I (▷ page 49).

After the initial wipe, pauses between wipes are automatically controlled by the rain sensor.



Do not leave windshield wipers in intermittent setting when the vehicle is taken to an automatic car wash or during windshield cleaning. Wipers will operate in the presence of water sprayed on the windshield, and wipers may be damaged as a result.

The switch should not be left in intermittent setting as the wipers will wipe the windshield once every time the engine is started. Dust that accumulates on the windshield might scratch the glass and/or damage the wiper blades when wiping occurs on a dry windshield.

Headlamp cleaning system*

The switch is located on the left side of the dashboard.



① Headlamp washer switch

- ▶ Switch on ignition.
- ▶ Press switch ①.

The headlamps are cleaned with a high-pressure water jet.

For information on filling up the washer reservoir, see “Windshield washer system and headlamp cleaning system*” (▷ page 394).

Rear view mirror

More information on setting the rear view mirrors can be found in the “Getting started” section (▷ page 38).

Automatic antiglare rear view mirror

The reflection brightness of the exterior rear view mirror on the driver’s side and the interior rear view mirror will respond automatically to glare when

- the ignition is switched on, and
- incoming light from headlamps falls on the sensor in the interior rear view mirror.

The rear view mirror will not react if

- reverse gear is engaged
- the interior lighting is turned on

Warning!



The automatic antiglare function does not react if incoming light is not aimed directly at sensors in the interior rear view mirror.

The interior rear view mirror and the exterior rear view mirror on the driver’s side do not react, for example, if the rear window sun shade* is in raised position.

Glare can endanger you and others.

Warning!



In the case of an accident, liquid electrolyte may escape from the mirror housing if the mirror glass breaks.

Electrolyte has an irritating effect. Do not allow the liquid to come into contact with eyes, skin, clothing, or respiratory system. In case it does, immediately flush affected area with water, and seek medical help if necessary.

Controls in detail

Good visibility

Warning!



Exercise care when using the passenger side exterior rear view mirror. The mirror surface is convex (outwardly curved surface for a wider field of view). Objects in mirror are closer than they appear. Check your interior rear view mirror or glance over your shoulder before changing lanes.



Electrolyte drops coming into contact with the vehicle paint finish can be completely removed only while in the liquid state by applying plenty of water.

Controls in detail

Good visibility

Activating exterior rear view mirror parking position

Follow these steps to activate the mirror parking position so that the passenger-side exterior rear view mirror will be turned downward to the stored position.

- ▶ Make sure you have stored a parking position for the passenger-side exterior rear view mirror (▷ page 118).
- ▶ Make sure the Mirror adjustment parking aid function in the Convenience submenu of the control system is switched to on (▷ page 151).
- ▶ Switch on ignition (if not already on).
- ▶ Press button ② for the passenger-side exterior rear view mirror.
- ▶ Place the gear selector lever in reverse gear **R**.

The passenger-side exterior rear view mirror will be turned downward to the stored position.

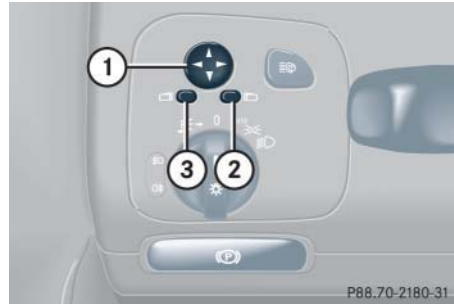

- ① Adjustment button
- ② Passenger-side exterior rear view mirror button
- ③ Driver's side exterior rear view mirror button

The exterior rear view mirror returns to its previously stored driving position:

- ten seconds after you put the gear selector lever out of position **R**
- immediately once your vehicle exceeds a speed of approximately 6 mph (10 km/h)
- immediately when you press button ③ for driver's side mirror.

Sun visors

The sun visors protect you from sun glare while driving.

Warning!



Do not use the vanity mirror while driving. Keep the mirrors in the sun visors closed while vehicle is in motion. Reflected glare can endanger you and others.

- ▶ Swing sun visors down when you experience glare.

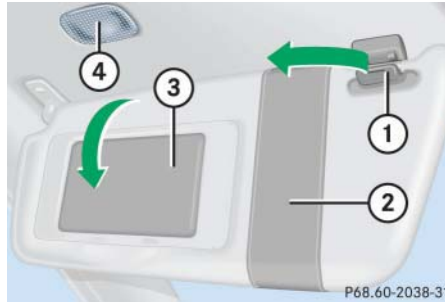

- ① Mounting
 - ② Sun visor
 - ③ Mirror cover
 - ④ Mirror lamp
- ▶ To use mirror, lift up cover ③.

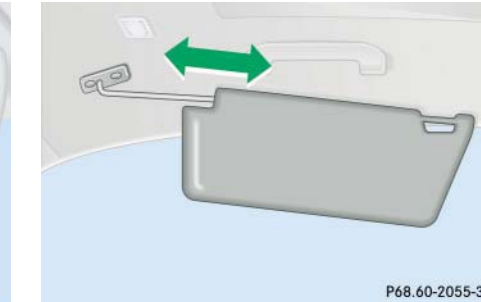

If sunlight enters through a side window:

- ▶ disengage sun visor from mounting ①.
- ▶ pivot sun visor to the side.

The sun visors are extendable.

- ▶ Adjust the sun visors by pushing or pulling in the direction of the arrow.



If you disengage the sun visor from mounting ①, mirror lamp ④ will switch off.

Controls in detail

Good visibility

Controls in detail

Good visibility

Rear window sunshade*

The switch is located in the center console.

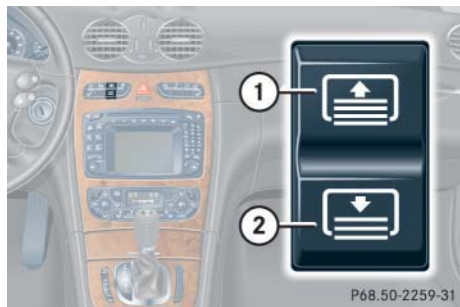

- ▶ Turn the SmartKey to starter switch position **1** or **2**. Vehicles with KEYLESS-GO*: press the start/stop button once or twice.
- ▶ Press the switch briefly at ① to raise the sunshade.
- ▶ Press the switch briefly at ② to lower the sunshade.

Always raise the sunshade fully for its support against the window frame.

Warning!



When operating the rear window sunshade, make sure there is no danger of anyone being harmed by the raising or lowering procedure.

The raising or lowering procedure can be immediately halted by briefly pressing the upper or lower half of the switch.

Briefly press upper or lower half of the switch again to raise or lower the rear window sunshade completely.

Warning!



When leaving the vehicle, always remove the SmartKey from the starter switch, take the SmartKey with KEYLESS-GO* with you and lock your vehicle. Do not leave children unattended in the vehicle, or with access to an unlocked vehicle. Unsupervised use of vehicle equipment may cause an accident and/or serious personal injury.

Rear window defroster

The rear window defroster uses a large amount of power. To keep battery drain to a minimum, switch off the defroster as soon as the rear window is clear. The defroster is automatically deactivated after approximately 6 to 17 minutes of operation depending on the outside temperature.

Activating

- ▶ Press button  (▷ page 173).

The indicator lamp on the button comes on.

Deactivating

- ▶ Press button  (▷ page 173) again.

The indicator lamp on the button goes out.

Controls in detail

Good visibility

Warning!



Any accumulation of snow and ice should be removed from the rear window before driving. Visibility could otherwise be impaired, endangering you and others.



If the rear window defroster switches off too soon and the indicator lamp starts flashing, this means that too many electrical consumers are operating simultaneously and there is insufficient voltage in the battery. The system responds automatically by deactivating the rear window defroster.

As soon as the battery has sufficient voltage, the rear window defroster automatically switches on again.

Controls in detail

Automatic climate control

▼ Automatic climate control

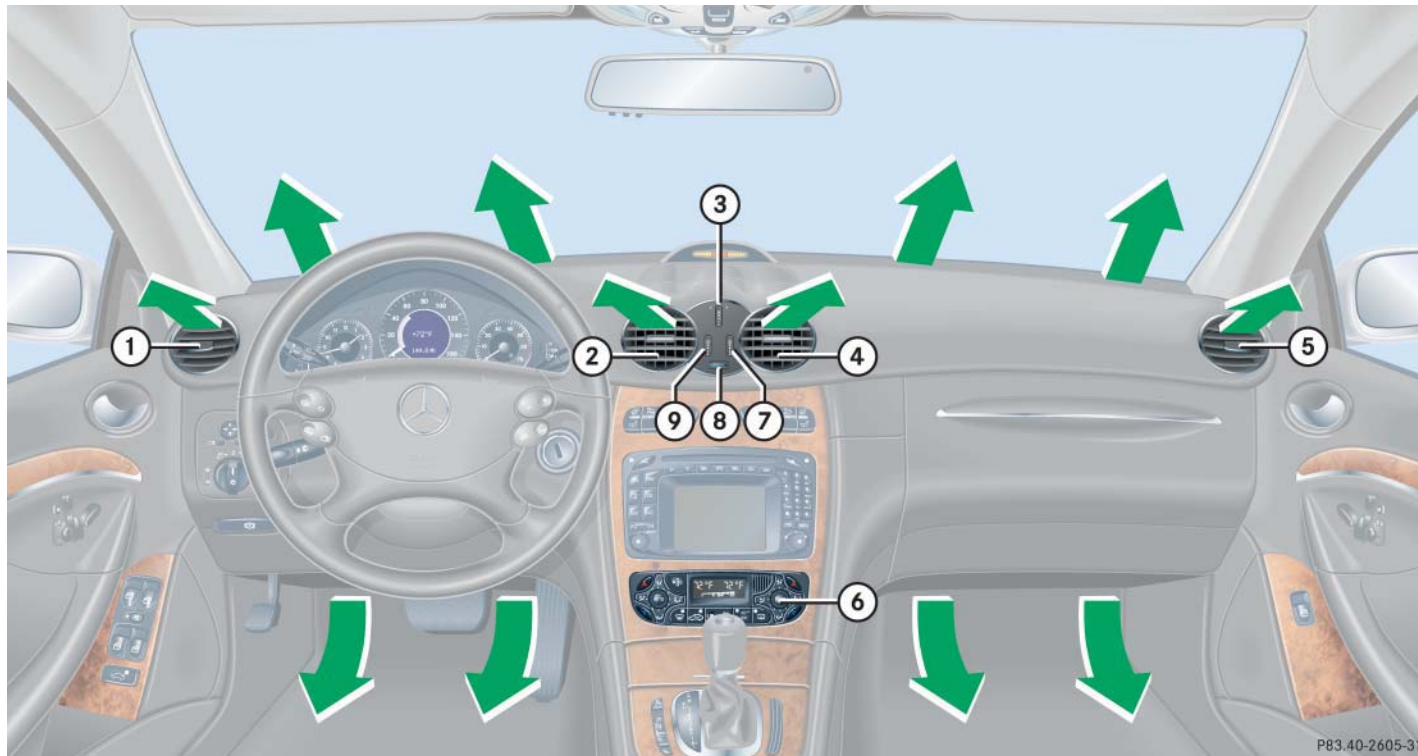

Item
① Left side air vent, adjustable
② Left center air vent, adjustable
③ Thumbwheel for air volume control for center air vents
④ Right center air vent, adjustable
⑤ Right side air vent, adjustable
⑥ Automatic climate control panel
⑦ Thumbwheel for air volume control for right side center air vent
⑧ Thumbwheel for lowering temperature, center and side air vents
⑨ Thumbwheel for air volume control for left side center air vent



For draft-free ventilation, move the sliders for the center air vents ①, ②, ④, ⑤ to the middle position.



Automatic climate control panel

Controls in detail

Automatic climate control

Item
① Temperature control, left, lowering
② Temperature control, left, raising
③ Left-side air distribution (automatic or manual operation)
④ Activated charcoal filter
⑤ Display
⑥ Right-side air distribution (automatic or manual operation)
⑦ Temperature control, right, raising
⑧ Temperature control, right, lowering
⑨ Rear window defroster
⑩ AC cooling on/off  Residual heat/ventilation
⑪ Air volume control
⑫ Automatic climate control on/off (complete system)
⑬ Air recirculation
⑭ Defrosting

Controls in detail

Automatic climate control

The automatic climate control is operational whenever the engine is running. You can operate the climate control system in either the automatic or manual mode. The system cools or heats the interior depending on the selected interior temperature and the current outside temperature.

Warning



When operating the automatic climate control, the air that enters the passenger compartment through the air vents in the footwell can be very hot or very cold (depending on the set temperature). This may cause burns or frostbite on unprotected skin in the immediate area of the air vents. Always keep sufficient distance between unprotected parts of the body and the footwell air vents. If necessary change the air flow using the air distribution controls to direct the air away from the footwell air vents (▷ page 176).

Nearly all dust particles, pollutants and odors are filtered out before outside air enters the passenger compartment through the air distribution system.

The air conditioning will not engage (no cooling) if the  mode is selected (▷ page 181).

Warning!



Follow the recommended settings for heating and cooling given on the following pages. Otherwise the windows could fog up, impairing visibility and endangering you and others.



Severe conditions (e.g. strong air pollution) may require replacement of the filter before its scheduled interval. A clogged filter will reduce the air volume to the interior.

If the vehicle interior is hot, ventilate the interior before driving off.

Keep the air intake grille in front of the windshield free of snow and debris.

Do not obstruct air flow by placing objects on the air flow-through exhaust slots below the rear window.

Setting the temperature

Use temperature controls (▷ page 173) ① and ② for the left side or ⑦ and ⑧ for the right side to separately adjust the air temperature on each side of the passenger compartment. You should raise or lower the temperature setting in small increments, preferably starting at 72°F (22°C).



When operating the climate control system in automatic mode, you will only rarely need to adjust the temperature, air volume and air distribution.

Increasing

- ▶ Push temperature control ② and/or ⑦.

The automatic climate control system will correspondingly adjust the interior air temperature.

Decreasing

- ▶ Push temperature control ① and/or ⑧.

The automatic climate control system will correspondingly adjust the interior air temperature.

Adding outside air





- ▶ Turn thumbwheel ④ in dashboard (▷ page 172) to increase flow of outside air through air vents for center, left and right sides, as well as dashboard top center and rear passenger compartment.

Controls in detail

Automatic climate control





Adjusting air distribution

Use the air distribution controls ⑦ and ⑨ (▷ page 172) to separately adjust the air distribution on each side of the passenger compartment. The following symbols are found on the controls:

Symbol	Function
	Directs air through the center, side and rear passenger compartment air vents
	Directs air to the windows
	Directs air into the entire vehicle interior
	Directs air to the footwells

Adjusting manually





- ▶ Press left or right **AUTO** button.

The **AUTO** pops out, the , ,  and  symbols are visible.

Air distribution can be adjusted manually.



Adjusting automatically

- ▶ Press left or right **AUTO** button again.

The , ,  and  symbols are no longer visible.

The air distribution is adjusted automatically.

Windshield fogged on the outside

- ▶ Switch the windshield wipers on, see “Windshield wipers” (▷ page 48).
- ▶ Switch to manual mode.
- ▶ Close the air vent at dashboard top center.
- ▶ Turn the air distribution control to  or .

Adjusting air volume

Adjusting manually





Seven blower speeds are available.

- ▶ Press left **0** or right  side of air volume control switch until the requested blower speed is attained.

The display “AUTO” disappears and the automatic mode is switched off. The selected blower speed is shown in the display.

Adjusting automatically

- ▶ Press left or right **AUTO** button until it clicks in.

The , ,  and  symbols are no longer visible.

The air volume is adjusted automatically.

Maximum cooling MAXCOOL

If the left and right air distribution controls as well as the airflow volume control are set to **AUTO** and there is a high need for cooling, the display “MAXCOOL” appears.

This provides the fastest possible cooling of the vehicle interior (when windows and sliding/pop-up roof are closed).

Defrosting



These settings should only be selected for a short time.

Activating

- ▶ Press button  (▷ page 173).

The indicator lamp on the button comes on.

Switch off air recirculation, if selected.

- ▶ Press button  (▷ page 173).

The indicator lamp on the button goes out.

- ▶ Close center air vents.
- ▶ Adjust side air vents upwards.

Deactivating

- ▶ Press button  (▷ page 173).

The indicator lamp on the button goes out. Defrosting is turned off.

Controls in detail

Automatic climate control

Air recirculation mode

Switch to air recirculation mode to prevent unpleasant odors from entering the vehicle from the outside. This setting cuts off the intake of outside air and recirculates the air in the passenger compartment.

Warning!



When the outside temperature is below 41°F (5°C), only switch to air recirculation mode for short periods to prevent window fogging.

Activating

- ▶ Press button  (▷ page 173).
The indicator lamp on the button comes on.





If you keep button  pressed, the side windows and the sliding/pop-up roof* will close.

Warning



Never operate the side windows and the sliding/pop-up roof* if there is the possibility of anyone being harmed by the closing procedure.

In the event that the procedure causes potential danger, the closing of the side windows can be immediately halted by releasing the  button or by pressing or pulling the respective window switch. The closing of the sliding/pop-up roof* can be immediately halted by releasing the  button or by moving the sliding/pop-up roof* switch in the overhead control panel in any direction.



The air recirculation mode is activated automatically:

- at high outside temperatures
- if the concentration of carbon monoxide and nitrogen oxide in the outside air increases, for example in a tunnel

Please note that the charcoal filter must be activated (▷ page 179) for the air recirculation mode to be activated automatically.

If you have turned off the air conditioning system (▷ page 181) or the outside temperature is below 41°F (5°C), the air recirculation mode will not switch on automatically.

Deactivating

- ▶ Press button  (▷ page 173).
The indicator lamp on the button goes out.



If you keep button  pressed, the side windows and the sliding/pop-up roof* will return to their previous position.



The air recirculation mode is deactivated automatically:

- after five minutes if the outside temperature is below approximately 41°F (5 °C)
- after five minutes if the air conditioning is turned off
- after 30 minutes if the outside temperature is above approximately 41°F (5 °C)

At outside temperatures above 79°F (26 °C) the system will not automatically switch back to outside air. A quantity of outside air is added after approximately 30 minutes.

Controls in detail

Automatic climate control

Charcoal filter

An activated charcoal filter markedly reduces bad odors and removes pollutants from air entering the passenger compartment.

Activating

- ▶ Press button  (▷ page 173).
The indicator lamp on the button comes on.



If you keep button  pressed, the side windows and the sliding/pop-up roof* will close.



Controls in detail

Automatic climate control

Warning



Never operate the side windows and the sliding/pop-up roof* if there is the possibility of anyone being harmed by the closing procedure.

In the event that the procedure causes potential danger, the closing of the side windows can be immediately halted by releasing the  button or by pressing or pulling the respective window switch. The closing of the sliding/pop-up roof* can be immediately halted by releasing the  button or by moving the sliding/pop-up roof* switch in the overhead control panel in any direction.

Deactivating

- ▶ Press button  (▷ page 173).

The indicator lamp on the button goes out.



If you keep button  pressed, the side windows and the sliding/pop-up roof* will return to their previous position.

The system switches automatically to the air recirculation mode if the carbon monoxide (CO) or nitrogen oxide (NO_x) concentration of the outside air increases beyond a predetermined level.

The automatic air recirculation mode does not function if economy mode  is selected or if the outside temperature has fallen below 41°F (5°C).

The activated charcoal filter should be switched off when windows fog up on the inside, or if the passenger compartment needs to be quickly heated or cooled down.

Deactivating the climate control system

Deactivating

It is possible to deactivate the automatic climate control system.

- ▶ Press button  (▷ page 173) until the display is cleared.

The climate control system is deactivated.

Reactivating

- ▶ Press button  (▷ page 173).



When the automatic climate control system is deactivated, the air flow and circulation are also switched off. Only choose this setting temporarily to prevent the windows from fogging up.

Air conditioning

The air conditioning is operational while the engine is running and cools the interior air to the temperature set by the operator.



Condensation may drip out from underneath the vehicle. This is normal and not an indication of a malfunction.

Deactivating

It is possible to deactivate the air conditioning (cooling) function of the automatic climate control system. The air in the vehicle will then no longer be cooled or dehumidified.

- ▶ Press button  (▷ page 173).

The indicator lamp on the button  comes on.

Activating

Moist air can fog up the windows. You can dehumidify the air with the air conditioning.

- ▶ Press  again (▷ page 173).

The indicator lamp on the button  goes out.

The air conditioning system uses the refrigerant R134a. This refrigerant is free of CFCs which are harmful to the ozone layer.



If the  button on the automatic climate control panel starts to flash, this indicates that the air conditioning system is losing refrigerant. The compressor has turned itself off. The air conditioning cannot be turned on again.

Have the air conditioning system checked at the nearest authorized Mercedes-Benz Center.

Residual heat and ventilation*

With the engine switched off, it is possible to continue to heat or ventilate the interior for up to 30 minutes. This feature makes use of the residual heat produced by the engine.

Activating

- ▶ Turn the SmartKey in the starter switch to position **1** or **0** or remove it from the starter switch.
- ▶ Press button  (▷ page 173).

The indicator lamp on button  comes on.

Controls in detail

Automatic climate control

Deactivating

- ▶ Press button  (▷ page 173).

The indicator lamp on button  goes out.

The residual heat is automatically turned off:

- when the ignition is switched on
- after about 30 minutes
- if the battery voltage drops



How long the system will provide heating depends on the coolant temperature and the temperature set by the operator. The blower will run at speed setting **1** regardless of the air distribution control setting.

Rear passenger compartment adjustable air vents

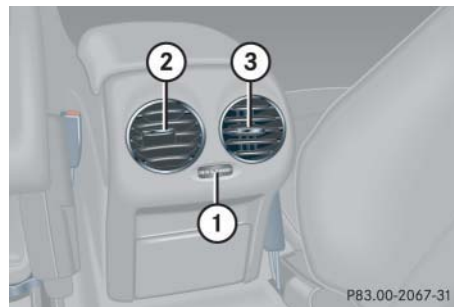

- ① Thumbwheel for center air vents with adjustable booster blower
- ② Left center air vent
- ③ Right center air vent

To open center air vents and to adjust the booster blower:

- ▶ Turn thumbwheel ①.



The booster blower allows airflow speed to the rear passenger compartment to be increased at four different levels.

The temperature at the air vents for rear passenger compartment ② and ③ is the same as at the dashboard center air vents.

▼ Audio system

Audio and telephone, operation

These instructions are intended to help you become familiar with your Mercedes-Benz audio system. They contain useful tips and a detailed description of the user functions.

Warning!



In order to avoid distraction which could lead to an accident, the driver should enter system settings with the vehicle at a standstill and operate the system only when road and traffic conditions permit. Always pay full attention to traffic conditions first before operating system controls while driving.

Bear in mind that at a speed of just 30 mph (approximately 50 km/h), your car is covering a distance of 50 feet (approximately 14 m) every second.

Operating safety

Warning!



Any alterations made to electronic components can cause malfunctions.

The radio, amplifier, CD changer*, satellite radio*, telephone* and voice control system* are interconnected. When one of the components is not operational or has not been removed/replaced properly, the function of other components may be impaired.

This condition might seriously impair the operating safety of your vehicle.

We recommend that you have any service work on electronic components carried out by an authorized Mercedes-Benz Center.

Controls in detail

Audio system

Operating and display elements

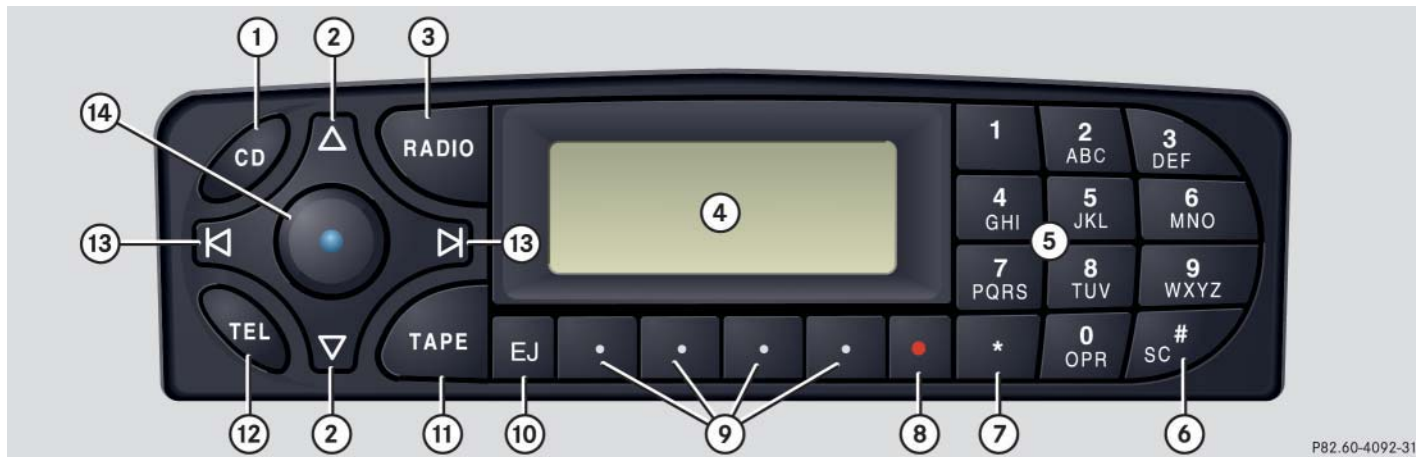

Controls in detail

Audio system

Item	Page
① CD mode selector	199
② Manual tuning (radio)	189
Fast forward/reverse (cassette, CD)	198, 202
Speed dialing memory (telephone*)	207
③ Radio mode selector	189
④ Display panel	
Cassette compartment behind display panel	

Item	Page
⑤ Alpha-numeric keypad	
Band selection, station buttons (radio)	189
CD selection (CD)	201
Telephone number entry, retrieving speed dialing memory (telephone)	204
⑥ Scanning (radio, cassette, CD)	191, 198, 202
⑦ Function button	190
⑧ Light-emitting diode	

Item	Page
⑨ Function keys	
⑩ Cassette eject	197
⑪ Cassette mode selector	196
⑫ Telephone* mode selector	203
⑬ Seek tuning (radio)	190
Track search (cassette, CD)	197, 202
Speed dialing memory (telephone)	207
⑭ On/off	186
Volume	186

Controls in detail

Audio system

Button and soft key operation

In these instructions, the alpha-numeric keypad (right side of radio panel) and the function buttons (left side of radio panel) are referred to as “buttons”. The four keys below the display panel are referred to as “soft keys”.



Do not press directly on the display face. Otherwise, the display will be damaged.

Operation

Switching on/off

Switching on:

- ▶ Turn SmartKey in starter switch to position **1** or **2**.

or

- ▶ Turn control knob



If the radio is switched on without the SmartKey in the starter switch, it will automatically switch off again after approx. 30 minutes.

Switching off:

- ▶ Remove SmartKey from starter switch.

or

- ▶ Turn control knob

Adjusting the volume

- ▶ Turn control knob .

The volume will increase or decrease depending on the direction turned.



The volume setting can be selected separately for the telephone*, audio system and voice control system*.

Adjusting audio functions

Press the AUD key to call up the bass, treble, balance and fader functions in the various operating modes. Settings for bass and treble are stored separately for the AM and FM frequency bands, satellite radio (SAT) mode, cassette mode and CD mode.

Controls in detail

Audio system

Bass

- ▶ Regardless of operating mode, press the **AUD** key repeatedly until **BASS** appears on the display.

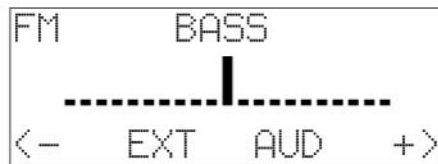

P82.60-4081-31

- ▶ Press **+** or **-** key to increase or decrease level.
- or
- ▶ Press both **+** and **-** keys simultaneously to reset the Bass to its center (flat) level.

Treble

- ▶ Regardless of operating mode, press the **AUD** key repeatedly until **TREBLE** appears on the display.

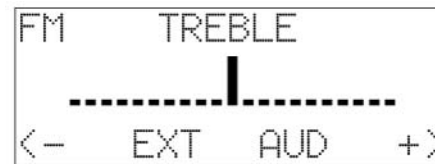

P82.60-4082-31

- ▶ Press **+** or **-** key to increase or decrease level.
- or
- ▶ Press both **+** and **-** keys simultaneously to reset the Treble to its center (flat) level.

Fader



Your vehicle may or may not have the fader function, depending on the vehicle equipment and model.

- ▶ Regardless of operating mode, press the **AUD** key repeatedly until **FADER** appears on the display.

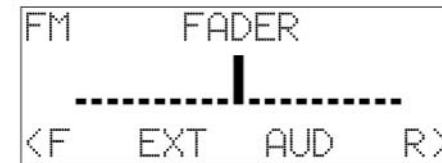

P82.60-4083-31

- ▶ Press **F** or **R** key to shift sound accordingly to the front or rear speakers.

or

- ▶ Press both **F** and **R** keys simultaneously to reset the Fader to its center level.

Controls in detail

Audio system

Balance

- ▶ Regardless of operating mode, press the **AUD** key repeatedly until **BALANCE** appears on the display.



P82.60-4084-31

- ▶ Press **L** or **R** key to shift sound accordingly to the left or right speakers.

or

- ▶ Press both **L** and **R** keys simultaneously to reset the Balance to its center level.

Returning audio functions to factory settings



P82.60-4085-31

- ▶ Regardless of operating mode, press and hold **AUD** key longer than two seconds. **RESET** will appear on the display.

All settings for bass, treble and balance are returned to the center level and the volume is set to a predefined level.

Audio system sound selection (EXT)*

- ▶ Regardless of operating mode, press the **AUD** key.

The sound settings menu appears on the display.

- ▶ Press the **EXT** key.



P82.60-4065-31

- ▶ Press one of the function keys.

You can select from among the following settings:

- **DRV:** The tone level is set to the Driver position; sound is directed toward the passengers.
- **SP:** The tone level is set for Speech, optimizing the sound for the spoken word.
- **AMB:** The tone level is set for Ambience, producing a three-dimensional sound.
- **OFF:** The audio system sound selection is turned off.

Telephone* muting

If a telephone has been installed in the vehicle, the radio will switch to telephone mode when a call is incoming. The current audio source is muted.

Radio operation

Selecting radio mode

- ▶ Press **RADIO** button.
- ▶ You can now receive radio stations over the analog FM, AM or WB station frequencies or you can receive channels digitally via satellite radio (SAT)*.

Analog station frequencies

Selecting the band

You can select from among FM, AM or WB frequency bands.

Weather band (▷ see page 192).



FM frequency band:
FM 87.7.....107.9 MHz
AM frequency band:
MW (medium wave) 530.....1710 KHz

- ▶ Press FM, AM or WB key repeatedly until desired band has been selected.

The FM, AM and WB frequency bands are called up one after the other.

The frequency band currently selected appears in the upper left-hand corner of the display.

Selecting a station

The following options are available for selecting a station:

- Direct frequency band input (▷ page 190)
- Manual tuning (▷ page 190)
- Automatic seek tuning (▷ page 190)
- Scan tuning (▷ page 191)
- Preset buttons (▷ page 191)
- Automatic station memory (Autostore) (▷ page 191)

Controls in detail

Audio system

Direct frequency input

Select the desired frequency band.



P82.60-4061-31

- ▶ Press ***** button.
- ▶ Enter desired frequency using buttons **1** to **0**.



You can only enter frequencies within the respective waveband.

If a button is not pressed within four seconds, the radio will return to the station last tuned to.

Manual tuning

▶ Select the desired frequency band.



P82.60-4057-31

- ▶ Press and hold either the **▲** or **▼** button until the desired frequency is reached.

Step-by-step station tuning takes place in ascending or descending order of frequency. The first three tuning steps will take place without muting. Afterwards, the radio will be muted and highspeed tuning will take place until the button is released.

Automatic seek tuning

▶ Select the desired frequency band.



P82.60-4059-31

- ▶ Press either the **▶** or **◀** button. The radio will tune to the next higher or next lower receivable frequency.

Controls in detail

Audio system

Scan tuning

- Starting scan tuning
 - ▶ Select desired frequency band.



- ▶ Press **SC#** button.
SC will appear on the display. The radio briefly tunes in all receivable stations on the band selected. The first scan cycle will tune in only the stations with a strong signal. The second scan cycle will tune in every receivable station.
- Ending scan tuning
 - ▶ Press **SC#** button or **▲**, **▼**, **▶** or **◀** button.
SC disappears from the display.

Manual station memory (Presets)

You can store ten AM and ten FM stations.

- Storing stations
 - ▶ Tune in the desired station.
 - ▶ Press and hold desired station button **1** to **0** until a brief signal tone is heard.



The frequency is stored on the selected station button.

The frequency band and station button number are shown in the upper left-hand corner of the display.

- Retrieving a station from memory
 - ▶ Press desired station button **1** to **0**.

Automatic station memory (Autostore)

The Autostore memory function provides an additional memory level. The station memory for manually stored stations is not overwritten.

- Calling up Autostore memory level
 - ▶ Briefly press the AS key.

AS is highlighted in the display.

The radio finds the ten stations with the strongest signals. These stations are stored on the station buttons **1** to **0** in order of signal strength.

- Retrieving a station from memory
 - ▶ Press desired station button **1** to **0**.
- Leaving the Autostore memory level
 - ▶ Press the AS key.

The highlighted AS in the display disappears.

Controls in detail

Audio system

Weather band



P82.60-4060-31

- ▶ Press the WB key.
The weather band station last selected is tuned in.
- ▶ Select the desired weather band station with buttons **1** to **7** PQRS.
If a station cannot be tuned in, a scan is automatically started.
- ▶ Press **▶** or **◀** button. The next receivable weather band station is tuned in.

Satellite radio (SAT)* (USA only)



Additional optional satellite radio equipment and a subscription to satellite radio service provider is required for the satellite radio operation described here. Feature description is based on preliminary information available at time of printing.

At time of printing, no date for availability of optional equipment required for satellite radio operation had been set. Contact your authorized Mercedes-Benz Center for details and availability for your vehicle.

Satellite radio service may be unavailable or interrupted from time to time for a variety of reasons, such as environmental or topographic conditions and other things we can't control. Service might also not be available in certain places (e.g., in tunnels, parking garages, or within or next to buildings) or near other technologies.

Sirius Satellite Radio provides 100 channels of digital-quality radio, among others music, sports, news, and entertainment, free of commercials. Sirius Satellite Radio uses a fleet of high-power satellites to broadcast 24 hours per day coast-to-coast.

This diverse, satellite-delivered programming is available for a monthly subscription fee.

For more information, call the Sirius service or contact www.siriusradio.com

Program categories

The channels are categorized. The categories allow you to tune to stations broadcasting a certain type of program (PTY mode) (▷ page 195).

Starting satellite radio (SAT)

- ▶ Start radio mode.

If the radio was in SAT radio mode before being turned off or changed to another operating mode, the last SAT channel selected is called up.

or

- ▶ Press the SAT key.

When you call up the SAT radio mode for the first time, ACQUIRING will appear on the display during the initialization process.

or



The last channel selected is called up.

Entering the Electronic Serial Number (ESN)

The first time SAT radio is called up, you must give your SAT radio provider the Electronic Serial Number (ESN) of your SAT receiver over the telephone.

- ▶ Press the SAT key.

The radio switches to SAT mode.

CALL SIRI appears on the display.



- ▶ Press the ESN key.

The provider's phone number will appear first. After pressing the ESN key again, the ESN number will appear.

Make note of the phone number and ESN number.

Controls in detail

Audio system

- ▶ Press the ESN key repeatedly until all required information has appeared on the display.
- ▶ Call the telephone number and give provider your ESN number.



Credit card information is also required for your application.

The activation process takes approximately five to ten minutes after calling the SIRIUS Service Center.

Controls in detail

Audio system

Channel selection

The following options are available for selecting a channel:

- Direct channel input (▷ page 194)
- Manual tuning (▷ page 194)
- Preset channels (▷ page 194)

Direct channel input



- ▶ Press ***** key.
- ▶ Enter desired channel number using buttons **1** to **0**.



Only inputs for available channels are possible.

If a button is not pressed within four seconds, the radio will return to the last station tuned.

Manual tuning

- ▶ Press and hold **▶**, **▲**, **▼** or **◀** button until the desired channel has been reached.

Preset channels

You can store up to ten channels.

- Retrieving a channel from memory
 - ▶ Press the desired channel button **1** to **0**.

- Storing channels

- ▶ Tune in the desired channel.
- ▶ Press and hold desired channel button **1** to **0** until a brief signal tone sounds.



The channel is stored on the selected channel button.

Program type (PTY) mode

In PTY mode, you can tune in and select channels of a specific program type.

Calling up PTY mode

- ▶ Start SAT radio mode.
- ▶ Press the **PTY** key.
The name of the channel currently being received is shown.

Leaving PTY mode

- ▶ Press the **CH** key.
The number of the channel currently being received is shown.

Selecting channel category

- ▶ Press **▲** or **▼** button.
The individual program types are selected.

Tuning in a PTY channel

Once you have selected a program type, you can tune in channels broadcasting a program that corresponds to the selected program type.

- ▶ Press **▶** or **◀** button.
The radio will tune to the next highest or lowest channel broadcasting this type of program.

Program Descriptive Text (PDT)

In PDT mode, you can call up additional information on the channel, the current track and the performing artist(s).

- ▶ Press the **TXT** key.
The station category appears on the display.
- ▶ Press the **TXT** key again within four seconds.
The title of the current track appears.
- ▶ Press the **TXT** key again within four seconds.
The name of the musician(s) of the current track appear on the display.

Controls in detail

Audio system

Cassette operation

Playing cassettes

- ▶ Press **[EJ]** button.

The display panel folds down and the cassette compartment becomes accessible.

- ▶ Insert cassette into the cassette compartment until it engages and tap it gently.

The cassette will be pulled in automatically. The system switches to cassette mode. Side 1 will be played and **SIDE 1** appears in the display. Side 1 is the side of the cassette which is facing upward. The cassette deck will automatically detect the type of tape.

- ▶ Fold display panel back up and press gently on the display panel frame to lock it in place.



Do not press directly on the display face. Otherwise the display will be damaged.

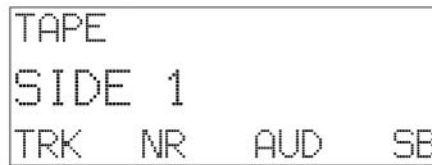

P82.60-4071-31

or

- ▶ If a cassette is already in the mechanism, press **[TAPE]** button.



A warning signal will sound after 20 seconds if the display panel is left in the down position. Fold display panel back up. If the display panel is not closed, a warning signal will sound and the radio will be muted.

Track selection

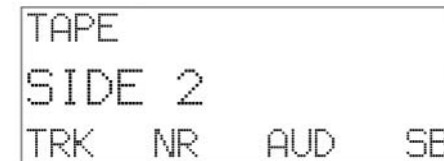

P82.60-4072-31

- ▶ Press the **TRK** key.
The current track will be displayed as **SIDE 1** or **SIDE 2**.
- ▶ You can switch sides at any time.
The side will be changed automatically at the end of the tape.

Cassette eject

- ▶ Press eject button **[EJ]**.
The display folds down and the cassette is ejected. The system will switch back to radio mode automatically.
- ▶ Fold display panel back up and press gently on the display panel frame to lock it.



Do not press directly on the display face. Otherwise the display will be damaged.



The cassette will not be ejected when the system is switched off or switched to another operating mode.

Track search

Track search forward



P82.60-4073-31

- ▶ Press **[▶]** button.
SEEK FWD will appear in the display. Track search will run the tape forward to the start of the next track and switch to Play.



The beginning of a track can only be found if there is pause of at least four seconds between tracks.

Controls in detail

Audio system

Track search backward

- ▶ Press **[◀]** button.
SEEK RWD will appear on the display. Track search will run the tape backward to the start of the track currently playing and switch to Play.

Stopping track search

- ▶ Press **[▲]**, **[▼]**, **[▶]** or **[◀]** button.
The cassette will switch over to Play.

Controls in detail

Audio system

Scanning

- Starting scan



- ▶ Press **SC#** button.
SC will appear on the display.
Each track on the cassette will be played briefly in ascending order.
- Stopping scan
 - ▶ Press **SC#**, **▲**, **▼**, **▶** or **◀** button.
The system will switch to Play.

Fast forward/reverse

- Starting cassette fast forward mode



- ▶ Press **▲** button.
FORWARD will appear on the display.
- Starting cassette fast reverse mode
 - ▶ Press **▼** button.
REWIND will appear on the display.

The cassette will automatically switch over to the play mode at the end or beginning of the tape.

- Stopping the cassette fast forward/reverse mode
 - ▶ Press **▲**, **▼**, **▶** or **◀** button.
The cassette will switch over to the play mode.

Skipping blank sections (skip blank)

Switching on the skip blank function

- ▶ Press the SB key.

SB is highlighted in the display.

If the system does not detect a sound signal, the cassette will automatically fast forward to the next sound signal.

Switching off the skip blank function

- ▶ Press the SB key.

The highlighted SB in the display disappears.

Dolby NR¹ (noise reduction system)

To enable optimum sound reproduction of cassettes recorded using Dolby B NR, the Dolby NR system should be switched on.



The Dolby NR function should be switched off when playing cassettes not recorded with Dolby B NR.

Switching on

- ▶ Press the NR key.
NR is highlighted in the display.

Switching off

- ▶ Press the NR key.
The highlighted NR in the display disappears.

CD changer* operation

General notes

Should excessively high temperatures occur while in CD mode, CD TEMP HIGH will appear on the display and the CD will be muted. The unit will then switch back to the last operating mode used until the temperature has decreased to a safe operating level.

```
CD 5
CD TEMP LOW
RDM RPT AUD T
```

P82.60-4066-31

Should excessively low temperatures occur while in CD mode, CD TEMP LOW will appear on the display, but the CD will continue to play.

Handle CDs carefully to prevent interference during playback. Avoid fingerprints and dust on CDs. Do not write on CDs or apply any labels or other material to them.

¹ DOLBY and the double-D symbol are trademarks of Dolby Laboratories Licensing Corporation.

The Dolby noise reduction system is manufactured under license from Dolby Laboratories Licensing Corporation.

Controls in detail

Audio system

Only use original CDs. Using copied CDs may create problems during playback.

Clean CDs from time to time with a commercially available cleaning cloth. Do not use solvents, anti-static sprays, etc. for cleaning. Replace the CD in its case after use. Protect CDs from heat and direct sunlight.



Only use CDs, which bear the label shown and that conform to the compact disc digital audio standard (IEC 60908). You can therefore only use CDs with a maximum thickness of 1.3 mm.



Use of CDs which do not meet this standard may cause damage to the CD changer. Do not play single-CDs (80 mm) with an adapter.

Your CD drive has been designed to play CDs which correspond to the EN 60908 standard.

If you insert thicker data carriers, e.g. ones that have data on both sides (one side with DVD data, the other side with audio data), they cannot be ejected and will damage the drive.

Warning!



The CD changer* is a Class 1 laser product. There is a danger of invisible laser radiation if the cover is opened or damaged. Do not remove the cover. The CD changer* does not contain any parts which can be serviced by the user. For safety reasons, have any service work which may be necessary performed only by qualified personnel.

Operational readiness of CD changer

If a CD changer has been installed in the system, it can be operated from the front control panel of the radio. A loaded magazine must be installed to play CDs.

Loading/unloading the CD magazine

- ▶ Slide changer door to the right and press eject button .
- ▶ The magazine will be ejected.

Controls in detail

Audio system

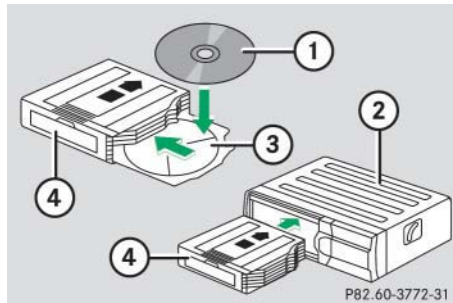

- ① CD
- ② CD changer
- ③ CD tray
- ④ CD magazine

- ▶ Remove magazine and pull CD tray fully out.
- ▶ Place CD in recess of tray, label side up.
- ▶ Push tray into magazine in direction of arrow.



CDs which have been inserted improperly or are unreadable will not be played.

- ▶ Push magazine into CD changer in direction of arrow and close sliding door.

Playing CDs

- ▶ Press **CD** button.

CD will appear on the display.

The last CD listened to will then start playing at the point where it was switched off. After the last track on a CD has finished, the next CD is automatically played.

Selecting CDs

```
CD 2
TRACK 1
RDM RPT AUD T
```

P82.60-4067-31

- ▶ You can select from among the CDs in the CD magazine using buttons **1** to **6**.

CD and the magazine slot number of the selected CD appear on the display. The number of the current track is displayed after TRACK.

```
CD 2
NO CD 5
RDM RPT AUD T
```



P82.60-4068-31



If there is no CD in the selected magazine slot, NO CD appears on the display with the corresponding slot number.

Controls in detail

Audio system

Skipping tracks forward/backward

- Skipping tracks forward
 - ▶ Press  button.
The next track will be played.
- Skipping tracks backward
 - ▶ Press  button.
If the track has been playing for more than ten seconds, it will revert to the start of that track. If it has been playing for less than ten seconds, it will revert to the preceding track.

Pressing the  or  button repeatedly will result in multiple tracks being skipped.

Fast forward/reverse

- Fast forward
 - ▶ Press and hold  button until desired point has been reached.

- Fast reverse
 - ▶ Press and hold  button until desired point has been reached.



The relative time of the track is shown on the display during the search.

Scanning

- Starting scan
 - ▶ Press **SC#** button.







CD 2 SC
TRACK 5
RDM RPT AUD T

P82.60-4069-31

SC appears in the display.

Each track on the current CD will be played for approx. eight seconds in ascending order.

- Ending scan
 - ▶ Press **SC#**, , ,  or  button.

Random play

The random play function (RDM) plays the tracks on the current CD in random order.

- Switching on random play



CD 2
TRACK 1
RDM RPT AUD T

P82.60-4067-31

- ▶ Press the RDM key.
RDM is highlighted in the display.

- Switching off random play

- ▶ Press the RDM key.
The highlighted RDM in the display disappears.

Repeat

The repeat function (RPT) repeats the current track.

Switching on repeat:



P82.60-4067-31

- ▶ Press the RPT key.
RPT is highlighted in the display.

Switching off repeat:

- ▶ Press the RPT key.
The highlighted RPT in the display disappears.



The Random play and Repeat function cannot be used simultaneously.

Track and time display



P82.60-4070-31

- ▶ Press the T key.
The number of the track being played and the elapsed playing time appear in the display.
- ▶ Press the T key.
The total number of tracks and the total playing time of the CD appear in the display.
The CD main menu appears again after eight seconds.

Telephone* operation

Various car telephone* functions and operating steps for the car telephone can be performed and displayed via the audio system.

Further operating instructions not covered here can be found in the operating instructions for the multifunction steering wheel, voice control* and the telephone*.

Controls in detail

Audio system

Switching on the telephone

- ▶ Press **TEL** button.
If you have programmed an unlock code for the telephone, you must enter the code now.
- ▶ Enter the desired telephone number using buttons **1** to **0**.
- ▶ If necessary, correct number entered with the CLR key. Press key briefly to delete the last digit entered; press key and hold to delete the complete number.
- ▶ Press the OK key after entering correct code.
The telephone is unlocked. If you have entered the wrong code, you must repeat the entering procedure with the correct code.

Switching off the telephone

- ▶ Press **TEL** button repeatedly until PHONE OFF appears in the display.
The receiving symbol in the display disappears.

Adjusting the volume

- ▶ Turn control knob  during telephone operation.

The volume increases or decreases depending on the direction in which the knob is turned.



The volume can be adjusted separately for the telephone*, voice control system* and radio.

Placing a call

Entering a telephone number and starting the dialing process

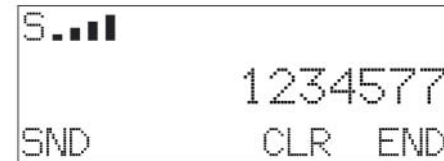

P82.60-4076-31

- ▶ Enter the desired telephone number using buttons **1** to **0**.
The number can have up to 32 digits, but only 13 of these are visible on the display.
If necessary, correct number entered with the CLR key.
- ▶ Press key briefly to delete the last digit entered.
- ▶ Press key and hold to delete the complete number.
- ▶ After correct telephone number has been entered, press the SND key.

Phone book

The numbers stored in the phone book can be called up either by name or number.

Calling up the phone book

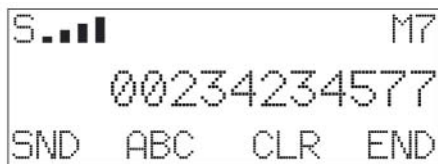

P82.60-4077-31

- ▶ Press , ,  or  button.

Switching between name search and number search

- ▶ Press the ABC key.

The name search is called up.

or

- ▶ Press the NUM key.

The number search is called up.

Searching and calling up phone book entries by name

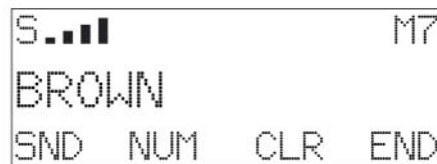

P82.60-4078-31

- ▶ Press the ABC key.
The current name is highlighted on the display.

Controls in detail

Audio system

- ▶ Press either the  or  button.



The stored entries are selected according to the alphabetical order of the initial letter.

or

- ▶ Press either the  or  button.

The stored entries are selected in increments of four.

or

- ▶ Press the desired numerical key  to .

The stored entries are selected according to the alphabetical order of the initial letters (e.g. for B -Brown, press button  twice).



Several characters and symbols cannot be shown on the display for technical reasons. They have been replaced with spaces.



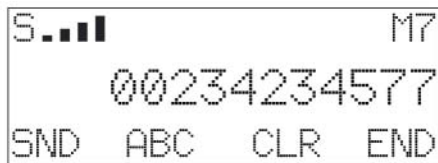

Controls in detail

Audio system

Searching and selecting phone book entries by number



P82.60-4077-31

- ▶ Press the NUM key.
The current number is marked in the display.
 - ▶ Press either the  or  button.
The stored entries are selected according to numerical order.
- or
- ▶ Press either the  or  button.
The stored entries are selected in increments of 5 (e.g. Entry M5, Entry M10, etc.)

Starting dialing process

- ▶ Once you have selected a number, press the SND key.



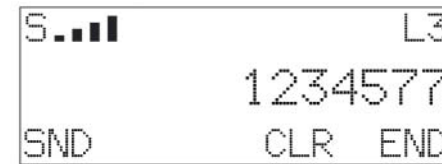

Repeat dialing

If the number dialed is busy, you can again place calls to the last ten telephone numbers dialed using the repeat dialing function.

Manual repeat dialing (redial)



P82.60-4079-31

- ▶ Press the SND key.
The last number dialed is shown in the display.
- ▶ Select the desired telephone number using , ,  or  button.
The abbreviation L and the number of the entry are shown in the top line of the display.
- ▶ When you have selected a number, press the SND key.
The call will be made.

Automatic repeat dialing (redial)

If a call cannot be connected, press the **SND** key.

REDIAL will appear on the display and repeated attempts to place the call will be made for the next four minutes.

Selecting numbers directly from the directory

- ▶ Enter previously selected 3-digit (1-999) number of the entry using number keys **1** to **0**.
- ▶ Press the **RCL** key.
The telephone number stored under that entry will be dialed.
- ▶ Press the **SND** key.
The call will be made.

Speed dialing

- ▶ Input desired entry number using number keys **1** to **0**.

A maximum of two digits can be entered.

If necessary, correct the last number entered with the **CLR** key.

- ▶ Press the **SND** key.

The telephone number stored under that entry will be dialed. The number, **L** and the full entry number will be shown in the display.

Quick-dialing

- ▶ Press one of the desired number buttons **1** to **0** longer than one second.

The telephone number saved under that number will be dialed.



Please be aware that button **1** might already be reserved for an emergency call number.

Controls in detail

Audio system

Emergency call

- ▶ Press button **1** longer than one second.
- ▶ A call will be placed to the saved number (e.g. 911).



Please be aware that the 911 emergency call system is a public service. Using it without due cause is a criminal offense.

You can make an emergency call to an emergency rescue station with a mobile communications network.

The emergency call will be placed as long as the corresponding mobile communications network is available. To do this, switch the telephone on if this has not already been done.

The call will also be placed even if the unlock code is not entered.

Emergency calls may not be possible with all telephone networks or if certain network services and/or telephone functions are active. Check with your local network operation company. It may take some time to set up an emergency call.

To use this function you must ensure that the number stored in memory location 1 is the number to be dialed in case of emergency.

If an emergency call cannot be connected, the message `SYSTEM BUSY` appears.

Accepting an incoming call

Accepting an incoming call in telephone mode

With an incoming call, a ringing tone can be heard and the caller's telephone number, or the name under which this telephone number has been saved in the telephone book, appears on the display. If the caller's number is not transmitted, `CALL` will appear in the display.

- ▶ Press the `SND` key to accept call.

Accepting an incoming call in cassette, CD or radio mode

If the telephone is activated in the background (receiving symbol **S** visible on display), the audio source is muted when a call is received. The ringing tone is heard and the caller's telephone number or the name under which this telephone number has been saved in the telephone book appears on the display. If the caller's number is not transmitted, **CALL** appears in the display.

- ▶ Press the **SND** key to accept the call.

Muting a call

It is possible to mute a call; the caller is then no longer able to hear you.

Mute on

- ▶ Press the **MUT** key.

Mute off

- ▶ Press the **MUT** key.

Terminating a call

- ▶ Press the **END** key.

The current call is terminated.

Call waiting

If you receive another call during an already active call, you can accept the second call and switch between the two.

Accepting a second call

- ▶ Press the **SND** key.

You are connected with the second caller, the first call is muted.

Switching between the calls

- ▶ Press the **SND** key.

Terminating the second call

- ▶ Press the **END** key.

The current call will be terminated. You are connected with the muted call again.

Controls in detail

Power windows

▼ Power windows

Opening and closing the windows

The side windows can be opened and closed electrically. The switches for all the side windows are on the driver's door. The switches for the respective windows are on the front passenger door and the rear side trim panels.

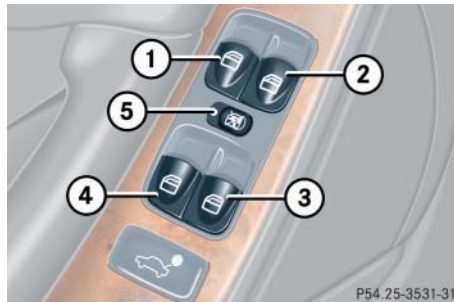

- ① Left front window
- ② Right front window
- ③ Right rear window
- ④ Left rear window
- ⑤ Rear window override switch
(▷ page 74)

Warning!



When closing the windows, make sure there is no danger of anyone being harmed by the closing procedure.

The closing of the door windows can be immediately halted by releasing the switch or, if switch was pulled past the resistance point and released, by either pressing or pulling the respective switch.

The closing of the rear side windows can be immediately halted by releasing the switch.



The door windows are equipped with the express-close and automatic reversal function. If a door window encounters an obstruction that blocks its path in a circumstance where you pulled the switch past the resistance point and released it to close the window, the automatic reversal function will stop the window and open it slightly.

If a door window encounters an obstruction that blocks its path in a circumstance where you are closing the window by pulling and holding the switch, by pressing and holding button  on the SmartKey, or by pressing and holding the lock button (vehicles with KEYLESS-GO*) on the door handle, the automatic reversal function will not operate.

When leaving the vehicle, always remove the SmartKey from starter switch, take the SmartKey with KEYLESS-GO* with you, and lock your vehicle. Do not leave children unattended in the vehicle, or with access to an unlocked vehicle. Unsupervised use of vehicle equipment can cause an accident and/or serious personal injury.



You can also open or close the windows using the:

- SmartKey (summer opening/convenience feature) (▷ page 212)
- button  in the control panel of the automatic climate control (▷ page 173).
- button  in the control panel of the automatic climate control (▷ page 173).

- ▶ Turn SmartKey in the starter switch to position **1** or **2** or press the KEYLESS-GO* start/stop button.

Opening the windows

- ▶ Press switch ① to ④ to the resistance point.
The corresponding window will move downwards until you release the switch.

Closing the windows

- ▶ Pull on switch ① to ④ to the resistance point.
The corresponding window will move upwards until you release the switch.

Controls in detail

Power windows

Fully opening the door windows (Express-open)

- ▶ Press switch ① or ② past the resistance point and release.
The corresponding window opens completely.

Fully closing the door windows (Express-close)

- ▶ Pull switch ① or ② past the resistance point and release.
The corresponding window closes completely.

Warning!



If you pull and hold the switch up when closing the window, and upward movement of the window is blocked by some obstruction including but not limited to arms, hands, fingers, etc., the automatic reversal will not operate. ▷▷

Controls in detail

Power windows



If the upward movement of a door window is blocked during the closing procedure, the door window will stop and open slightly.

Remove the obstruction, pull the switch again past the resistance point and release.

If the door window still does not close when there is no obstruction, then pull the switch and hold it. The door window will then close without the obstruction sensor function.

Warning!



Driver's door only:
If within five seconds you again pull the switch past the resistance point and release, the automatic reversal will not function.

Stopping windows

- ▶ Press or pull respective switch again.



Opening and closing the windows with the SmartKey

The sliding/pop-up roof* (▷ page 214) will also be opened or closed when the power windows are operated with the SmartKey.

Warning!



Never operate the windows or sliding/pop-up roof* if there is the possibility of anyone being harmed by the opening or closing procedure.

In the event that the procedure causes potential danger, the procedure can be immediately halted by releasing the button on the SmartKey. To reverse direction of movement press  for opening or  for closing.

- ▶ Aim transmitter eye at the front door handle.

Opening (Summer opening feature)

- ▶ Press and hold button  after unlocking the vehicle.

The windows and sliding/pop-up roof* begin to open after approximately one second.

- ▶ Release the  button to stop procedure.

Closing (Convenience feature)

- ▶ Press and hold button  after locking the vehicle.

The windows and sliding/pop-up roof* begin to close after approximately one second.

- ▶ Release the  button to stop procedure.

Make sure all side windows and the sliding/pop-up roof* are properly closed before leaving the vehicle.

Closing the side windows and sliding/pop-up roof* with KEYLESS-GO

- ▶ Press and hold lock button at door (▷ page 55) until the side windows and the sliding/pop-up roof* are closed.

Warning!



When closing the windows and the sliding/pop-up roof* make sure there is no danger of anyone being harmed by the closing procedure.

The windows will not automatically reopen if blocked during convenience closing.

If potential danger exists, proceed as follows:

- Release the lock button.
- Pull on the door handle and hold firmly. The side windows and the sliding/pop-up roof* will open for about two seconds if the door handle is held but the door not opened.

Controls in detail

Power windows

Synchronizing power windows

The power windows must be resynchronized each time

- after the battery has been disconnected.
- if the power windows cannot be fully opened (Express-open) or closed (Express-close).

Synchronizing the power windows

- ▶ Switch ignition on.
- ▶ Pull the power window switches until the side windows are closed.
Hold the switches for approximately one second.
The power windows are adjusted.

Controls in detail

Sliding/pop-up roof*

▼ Sliding/pop-up roof*

Opening and closing the sliding/pop-up roof

The sliding/pop-up roof can be opened and closed electrically. The switch for the sliding/pop-up roof is on the overhead control panel.

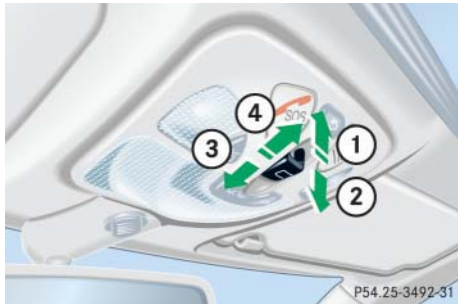

- ① Push up to raise roof at rear
- ② Pull down to lower roof at rear
- ③ Push forward to slide roof closed
- ④ Push back to slide roof open

With the roof closed or tilted open, a screen can be slid into the roof opening to guard against sun rays. When sliding the roof open, the screen will also retract.

Warning!



When closing the sliding/pop-up roof, make sure there is no danger of anyone being harmed by the closing procedure.

The closing procedure of the sliding/pop-up roof can be immediately halted by releasing the switch or, if the switch was moved past the resistance point and released, by moving the switch in any direction.

When leaving the vehicle, always remove the SmartKey from starter switch, take the SmartKey with KEYLESS-GO* with you, and lock your vehicle. Do not leave children unattended in the vehicle, or with access to an unlocked vehicle. Unsupervised use of vehicle equipment can cause an accident and/or serious personal injury.





To avoid damaging the seals, do not transport any objects with sharp edges which can stick out of the sliding/pop-up roof.

Do not open the sliding/pop-up roof if there is snow or ice on the roof, as this could result in malfunctions.

The sliding/pop-up roof can be opened or closed manually should an electrical malfunction occur (▷ page 348).



You can also open or close the sliding/pop-up roof using the:

- SmartKey (summer opening/convenience feature) (▷ page 212)
- button  in the control panel of the automatic climate control (▷ page 173)
- button  in the control panel of the automatic climate control (▷ page 173)

- ▶ Turn SmartKey in the starter switch to position **1** or **2** or press the KEYLESS-GO* start/stop button.

Controls in detail

Sliding/pop-up roof*

Opening and closing the sliding/pop-up roof

- ▶ To open, close, raise or lower the sliding/pop-up roof, move the switch to resistance point in the required direction ① to ④.

Release the switch when the roof has reached the desired position.

Fully opening (Express-open) and closing (Express-close) the sliding/pop-up roof

- ▶ To open, close, raise or lower the sliding/pop-up roof, move the switch past the resistance point in the required direction ① to ④ and release.

The sliding/pop-up roof opens or closes completely.

Controls in detail

Sliding/pop-up roof*

Stopping the sliding / pop-up roof

- ▶ Move the switch in any direction.

If the movement of the sliding/pop-up roof is blocked during the closing procedure, the roof will stop and reopen slightly.



Opening and closing the sliding/pop-up roof with the SmartKey

The power windows (▷ page 212) will also be opened or closed when you operate the sliding/pop-up roof with the SmartKey.

Warning!



Never operate the windows or sliding/pop-up roof if there is the possibility of anyone being harmed by the opening or closing procedure.

In the event that the procedure causes potential danger, the procedure can be immediately halted by releasing the button on the SmartKey. To reverse direction of movement, press  for opening or  for closing.

- ▶ Aim transmitter eye at the front door handle.

Opening (Summer opening feature)

- ▶ Press and hold button  after unlocking the vehicle.

The windows and the sliding/pop-up roof begin to open after approximately one second.

- ▶ Release the  button to stop procedure.

Closing (Convenience feature)

- ▶ Press and hold button  after locking the vehicle.

The windows and the sliding/pop-up roof begin to close after approximately one second.

- ▶ Release  button to stop procedure.

Make sure all side windows and the sliding/pop-up roof are properly closed before leaving the vehicle.

Closing the sliding/pop-up roof with KEYLESS-GO* (Convenience feature)

The power windows (▷ page 212) will also be closed when the sliding/pop-up roof is operated with the SmartKey.

- ▶ Press and hold lock button at door (▷ page 55) until the side windows and the sliding/pop-up roof are closed.

Warning!



When closing the windows and the sliding/pop-up roof, make sure there is no danger of anyone being harmed by the closing procedure.

The sliding/pop-up roof will not automatically reopen if blocked during convenience closing.

If potential danger exists, proceed as follows:

- Release the lock button.
- Pull on the door handle and hold firmly. The side windows and the sliding/pop-up roof will open for as long as the door handle is held but the door not opened.

Controls in detail

Sliding/pop-up roof*

Synchronizing the sliding/pop-up roof

The power sliding/pop-up roof must be re-synchronized each time after:

- the battery has been disconnected
- the sliding/pop-up roof has been closed manually
- the sliding/pop-up roof does not open smoothly
- a malfunction

Synchronizing

- ▶ Switch on ignition.
- ▶ Press and hold the switch in direction ① until the sliding/pop-up roof is fully raised at the rear.

Hold the switch for approximately one second.

The sliding/pop-up roof is adjusted.

Controls in detail

Driving systems

▼ Driving systems

The driving systems of your vehicle are described on the following pages:

- Cruise control and Distronic*, with which the vehicle can maintain a preset speed
- Parktronic*, which serves as a parking assistant.

For information on the BAS, ABS, and ESP driving systems, see “Driving safety systems” (▷ page 76).

Cruise control

Cruise control automatically maintains the speed you set for your vehicle.

Use of cruise control is recommended for driving at a constant speed for extended periods of time. You can set or resume cruise control at any speed over 20 mph (30 km/h).

The cruise control function is operated by means of the cruise control lever.

The cruise control lever is the uppermost lever found on the left-hand side of the steering column (▷ page 20).

Warning!



Cruise control is a convenience system designed to assist the driver during vehicle operation. The driver is and must remain at all times responsible for the vehicle speed and for safe brake operation.

Only use cruise control if the road, traffic and weather conditions make it advisable to travel at a steady speed.

- The use of cruise control can be dangerous on winding roads or in heavy traffic because conditions do not allow safe driving at a steady speed.
- The use of cruise control can be dangerous on slippery roads. Rapid changes in tire traction can result in wheel spin and loss of control.
- Deactivate cruise control when driving in fog.

The “Resume” function should only be operated if the driver is fully aware of the previously set speed and wishes to resume this particular preset speed.

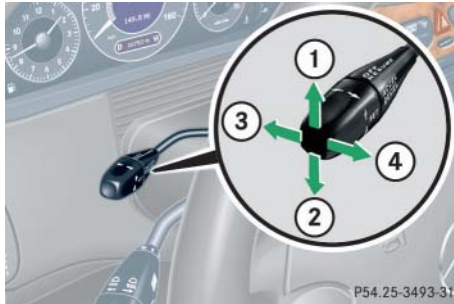

- ① Set current or higher speed
- ② Set current or lower speed
- ③ Cancel cruise control
- ④ Resume at last set speed

Setting current speed

- ▶ Accelerate or decelerate to the desired speed.
- ▶ Briefly lift ① or depress ② the cruise control lever.

The current speed is set.

- ▶ Remove your foot from the accelerator pedal.

Cruise control is activated.



On uphill or downhill grades, cruise control may not be able to maintain the set speed. Once the grade eases, the set speed will be resumed.

Canceling cruise control

There are several ways to cancel cruise control:

- ▶ Step on the brake pedal.
- or
- ▶ Briefly push the cruise control lever to position ③.

Cruise control will be canceled. The last speed set will be stored for later use.



Moving gear selector lever to position **N** while driving also cancels cruise control. However, the gear selector lever should not be moved to position **N** while driving except to coast when the vehicle is in danger of skidding (e.g. on icy roads).



The last stored speed is canceled when you turn off the engine.

Controls in detail

Driving systems

Setting a higher speed

- ▶ Lift cruise control lever to position ① and hold it up until the desired speed is reached.
- ▶ Release cruise control lever.
The new speed is set.



Depressing the accelerator pedal does not deactivate cruise control. After brief acceleration (e.g. for passing), cruise control will resume the last speed set.

Setting a lower speed

- ▶ Depress cruise control lever to position ② and hold it down until the desired speed is reached.
- ▶ Release cruise control lever.
The new speed is set.



When you use the cruise control lever to decelerate, the transmission will automatically downshift if the engine's braking power does not brake the vehicle sufficiently.

Fine adjustment in 1 mph (Canada: 1 km/h) increments

Faster

- ▶ Briefly tip cruise control lever in the direction of arrow ①.

Slower

- ▶ Briefly tip cruise control lever in the direction of arrow ②.

Setting to last stored speed ("Resume" function)

Warning!



The speed stored in memory should only be set again if prevailing road conditions permit. Possible acceleration or deceleration differences arising from returning to the pre-set speed could cause an accident and/or serious injury to you and others.

- ▶ Briefly push cruise control lever to position ④.
The cruise control will resume the last set speed.
- ▶ Remove your foot from the accelerator pedal.

Distronic*

When activated, the Distronic adaptive cruise control system increases the driving convenience afforded by the cruise control during travel on expressways and other major roads.

- If the Distronic distance sensor detects a slower moving vehicle directly ahead, your vehicle speed will be reduced so that you follow that vehicle at a preset distance.
- If there is no vehicle directly ahead of you, Distronic will function in the same way as cruise control (> page 218).

Warning!



Distronic adaptive cruise control is no substitute for active driving involvement. It does not react to stationary objects, nor recognize or predict the curvature and lane layout or the movement of vehicles ahead. Distronic can only apply a maximum of 20% of the vehicle's braking power.

It is the driver's responsibility at all times to be attentive to traffic and road conditions and to provide the steering, braking and other driving inputs necessary to retain control of the vehicle.

Warning!



Distronic is a convenience system. Its speed adjustment reduction capability is intended to make cruise control more effective and usable when traffic speeds vary. However, it is not intended to, nor does it, replace the need for extreme care. The responsibility for the vehicle speed and the distance to the vehicle ahead, including most importantly brake operation to assure safe stopping distance, always rests with the driver.

Distronic cannot take street and traffic conditions into account.

Controls in detail

Driving systems

Warning!



Distronic requires familiarity with its operational characteristics. We strongly recommend that you review the following information carefully before operating the system.



For operation in the USA only: This device complies with Part 15 of the FCC Rules. Operation is subject to the following two conditions:

- This device may not cause harmful interference, and
- this device must accept any interference received, including interference that may cause undesired operation.

Any unauthorized modification to this device could void the user's authority to operate the equipment.

Controls in detail

Driving systems

Warning!



Distronic cannot take street and traffic conditions into account. Only use DISTRONIC if the road, traffic and weather conditions make it advisable to travel at a steady speed.

Warning!



Use of DISTRONIC can be dangerous on slippery roads. Rapid changes in tire traction can result in wheel spin and loss of control.

DISTRONIC does not act upon adverse sight distance conditions. Do not use DISTRONIC during conditions of fog and heavy rain, snow or sleet.

Warning!



Close attention to road and traffic conditions is imperative at all times, regardless of whether or not DISTRONIC is activated.

Use of DISTRONIC can be dangerous on winding roads or in heavy traffic because conditions do not allow safe driving at a steady speed.

DISTRONIC will not react to stationary objects in the roadway (e.g. a stopped vehicle in a traffic jam or a disabled vehicle). DISTRONIC will also not respond to oncoming vehicles.

Switch off DISTRONIC:

- when changing from the left to the right lane if vehicles are moving more slowly in the left lane
- when entering a turn lane or highway off ramp
- in complex driving situations, such as in highway construction zones

In these situations, DISTRONIC will continue to maintain the set speed unless deactivated.

DISTRONIC is designed and intended only to maintain a set speed and keep a set distance from moving objects in front of it.

Warning!



The “Resume” function should only be operated if the driver is fully aware of the previously set speed and wishes to resume this particular preset speed.

Controls in detail

Driving systems

Distronic displays in the speedometer dial



① Set speed

If Disticronic is activated, one or two segments come on around the set speed.



The vehicle speed displayed on the speedometer can briefly vary from the speed setting on the Disticronic system.



① Segments

If Disticronic detects a vehicle directly ahead, the segments (representing the difference) between the speed of the vehicle ahead and the set speed come on.

If Disticronic calculates that there is a danger of collision when the distance warning function is activated (▷ page 230):

- The Disticronic warning lamp  in the instrument cluster comes on.
- An intermittent warning sounds.

- ▶ Immediately brake the vehicle to avoid a collision.

Under no circumstances should the driver await the intermittent warning sound before braking. See the following warning note.

The intermittent warning sound ceases and the Disticronic warning lamp  goes out when the necessary distance to the vehicle ahead is reestablished.

Controls in detail

Driving systems

Warning!



An intermittent warning sounds and the Distance warning lamp in the instrument cluster is illuminated if the Distronic system calculates that the distance to the vehicle ahead and your vehicle's current speed indicate that Distronic will not be capable of slowing the vehicle sufficiently to maintain the preset following distance, which creates a danger of a collision.

Immediately brake the vehicle to increase the distance to the vehicle in front of you. The warning sound is intended as a final caution that you have not interceded with your own braking inputs to avoid a potentially dangerous situation. Do not wait for the operation of the warning signal to intercede with your own braking, as that will result in potentially dangerous emergency braking which will not always result in an impact being avoided.

Tailgating increases the risk of an accident.

Warning!



Distronic brakes your vehicle with a maximum of 6.5 ft/s^2 (2 m/s^2). This corresponds to about 20% of the maximum deceleration ability of your vehicle.



Distronic brakes the vehicle in an effort to restore the preset distance or to maintain the speed. The brake pedal is automatically applied as this happens which results in the brake pedal moving.

Keep driver's foot area clear at all times, including the area under the brake pedal. Objects stored in this area may impair pedal movement which could interfere with the braking ability of the Distronic system.

Do not place your foot under the brake pedal – your foot could become caught.

Distronic menu in the control system

In the Distronic menu you see the current settings for Distronic. What appears in the display depends on whether Distronic and the distance warning function are turned on or off.

- ▶ Press button  or  repeatedly until you see one of the following displays.

Controls in detail

Driving systems

Distronic deactivated

If Distronic is deactivated the standard display of Distronic appears in the multifunction display.

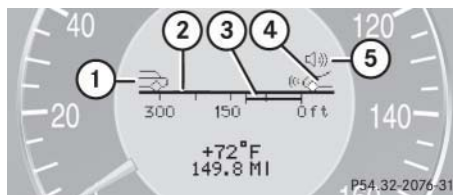

- ① Vehicle ahead, if detected
- ② Actual distance to vehicle ahead
- ③ Preset distance threshold to vehicle ahead
- ④ Your vehicle
- ⑤ Symbol for activated distance warning function

Distronic activated

When you turn Distronic on, you will see the set speed in the multifunction display for about five seconds. If Distronic is activated, you can see the following display in the multifunction display.

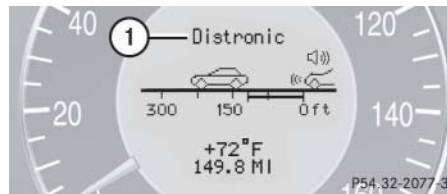

- ① Distronic activated

Cruise control lever

The Distronic system is operated by means of the cruise control lever.

The cruise control lever is the uppermost lever found on the left-hand side of the steering column.

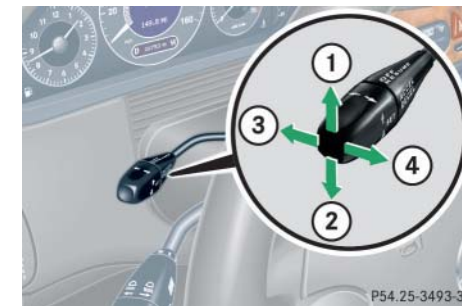

- ① Set current or higher speed
- ② Set current or lower speed
- ③ Deactivate Distronic
- ④ Resume at last set speed

Controls in detail

Driving systems

Activating Distronic

You can activate Distronic if

- you are driving between 25 mph (40 km/h) and 110 mph (180 km/h)
- the ESP is activated (▷ page 78)

If Distronic has not been activated after pressing the cruise control lever you will see the message --- in the multifunction display.

In the following cases you cannot activate Distronic:

- up to two minutes after starting the engine.
- when you brake.
- if you have set the parking brake.
- if the gear selector lever is in position **P**, **R** or **N**.
- if ESP is switched off.

Setting the current speed

- ▶ Accelerate or decelerate to the desired speed.
- ▶ Briefly lift or depress the cruise control lever.

Distronic is activated and the current speed is set.

- ▶ Remove your foot from the accelerator pedal.



If you do not take your foot off of the accelerator completely, the following message will appear in the multifunction display:

Distronic override.

Distronic will not work to maintain the distance to slower moving vehicles in front of you. Your vehicle speed will then be determined only by the accelerator pedal position.

Setting a higher speed

- ▶ Briefly tip cruise control lever in the direction of arrow ① (▷ page 225) to increase vehicle speed in increments of 5 mph (Canada: 10 km/h).

The new speed is set.

The stored speed is displayed in the multifunction display for approximately five seconds (▷ page 225), and one or two segments around the stored speed come on, on the speedometer (▷ page 223).



Depressing the accelerator pedal does not deactivate Distronic. After brief acceleration (e.g. for passing), the cruise control will resume the last speed set.

Setting a lower speed

- ▶ Briefly tip cruise control lever in the direction of arrow ② (▷ page 225) to decrease vehicle speed in increments of 5 mph (Canada: 10 km/h).

The new speed is set.

The stored speed is displayed in the multifunction display for approximately five seconds (▷ page 225), and one or two segments around the stored speed come on, on the speedometer (▷ page 223).



When you use the cruise control lever to decelerate, the transmission will automatically downshift if the rate of deceleration is too low.

Fine adjustment in 1 mph (Canada: 1 km/h) increments

Faster

- ▶ Briefly tip cruise control lever in the direction of arrow ④ (▷ page 225).

Setting to last stored speed ("Resume" function)

Warning!



The speed stored in memory should only be set again if prevailing road conditions permit. Possible acceleration or deceleration differences arising from returning to the preset speed could cause an accident and/or serious injury to you and others.

- ▶ Briefly tip cruise control lever in the direction of arrow ④ (▷ page 225).
DISTRONIC is set to the last stored speed.
- ▶ Remove your foot from the accelerator pedal.

Controls in detail

Driving systems

Deactivating Distronic

There are several ways to deactivate the Distronic system:

- ▶ Briefly tip cruise control lever in the direction of arrow ③ (▷ page 225).

or

- ▶ Step on the brake pedal.

Distronic will be deactivated. The last speed set will be stored into memory.



The following message will appear in the multifunction display for approximately five seconds: *Distronic off*.

The last stored speed is deleted when you turn off the engine.

Distronic deactivates automatically when

- you set the parking brake
- you drive slower than 25 mph (40 km/h)
- the ESP is active (▷ page 78) or you deactivate the ESP
- you move the gear selector lever into position **N**.

A signal will sound. The *Distronic off* message appears in the multifunction display for approximately five seconds.

Warning!



Distronic switches off and releases the brakes when the vehicle decelerates below the minimum speed of approximately 25 mph (40 km/h) by operation of the system. At that time the driver must apply the brakes in order to reduce vehicle speed further or bring it to a stop.

Setting the following distance in Distronic

You can set the specified following distance for Distronic by varying the time setting between 1.0 and 2.0 seconds. Using this time setting and the current speed of your vehicle, Distronic calculates and sets the required following distance to the vehicle ahead. The set distance will be shown in the multifunction display field.

The thumbwheel for making the time setting is located on the lower section of the center console.

Warning!



It is up to the driver to exercise discretion to select the appropriate setting given road conditions, traffic, driver's preferred driving style and applicable laws and driving recommendations for safe following distance.



- ① Distance warning function on/off switch
- ② Control lamp
- ③ Thumbwheel for setting distance

Increasing distance

Increasing the distance setting causes Distronic to maintain a greater following distance to the vehicle ahead.

- Turn thumbwheel ③ towards .

Decreasing distance

Decreasing the distance setting causes Distronic to maintain a shorter following distance to the vehicle ahead.

- Turn thumbwheel ③ towards .

Distance warning function

When Distronic is deactivated, this function will continue to warn you when recognizing a stationary obstacle or a slower vehicle moving in the vehicle's path and the danger of a collision exists:

- The distance warning lamp  in the instrument cluster comes on
- An intermittent warning sounds.

If these warnings are issued, you must brake manually to maintain a safe distance and avoid a collision with the vehicle ahead.

When pressing the brake pedal, the warning sound stops. The warning sound also stops when the distance to the vehicle

ahead is sufficient again without applying the brake pedal. In this case the distance warning lamp also extinguishes.

Warning!



If the distance warning lamp  in the instrument cluster comes on while driving and/or an intermittent warning sounds, immediate attention on the part of the driver is required.

As required by the traffic situation, apply the brakes and navigate around a possible obstacle. However, do not drive by relying on the distance warning function, as this will result in an emergency braking application. Especially depending on road surface conditions and driver reaction, this will not always enable you to avoid a collision.



Complex driving situations are not always fully recognized by Distronic. This could result in wrong or missing distance warnings.

Controls in detail

Driving systems

Activating

- ▶ Press switch ①.

Indicator lamp ② on the switch comes on. A loudspeaker symbol appears in the multifunction display (▶ page 225).

Deactivating

- ▶ Press switch ①.

Indicator lamp ② on the switch goes out. No loudspeaker symbol appears in the multifunction display.

Driving with DISTRONIC

This section describes a number of driving situations where special precaution is required on the part of the driver. Be prepared to brake in such situations. This will deactivate the DISTRONIC system.

Warning!



DISTRONIC works to maintain the speed selected by the driver unless a moving obstacle proceeding directly ahead of it in the same travel direction is detected (e.g. following another vehicle ahead of you at a distance set by DISTRONIC). This means that:

- Your vehicle can pass another vehicle after you change lanes.
- While in a sharp turn or if the vehicle in front is in a sharp turn, DISTRONIC could lose sight of a vehicle traveling in front of it. Your vehicle could then accelerate to the previously selected speed.

DISTRONIC regulates only the distance between your vehicle and those directly ahead of it, but does not register stationary objects in the road, e.g.:

- a stopped vehicle in a traffic jam
- a disabled vehicle
- an oncoming vehicle

The driver must always be on the alert, observe all traffic and intercede as required by steering or braking the vehicle.

Warning!



DISTRONIC should not be used in snowy or icy road conditions.

The most likely cause for a malfunctioning system is a dirty sensor (located behind the hood grille), especially at times of snow and ice or heavy rain. In such a case, Distronic will switch off, and the message Distronic Currently unavailable! see oper. manual appears in the multifunction display.

For cleaning and care of the Distronic sensor, see "Cleaning the Distronic* system sensor cover" (▷ page 301).



If the message Distronic Currently unavailable! see oper. manual disappears during driving and the last speed stored flashes for approximately five seconds, the dirt (e.g. slush) has dissolved; Distronic works again.

Controls in detail

Driving systems

Turns and bends

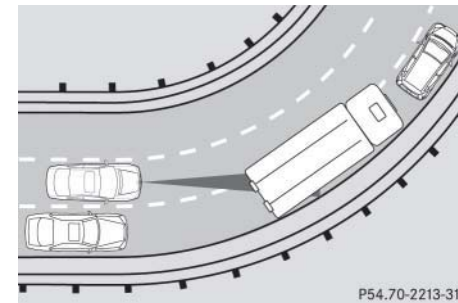

In turns or bends, Distronic may not detect a moving vehicle in front, or it may detect one too soon. This may cause your vehicle to brake late or unexpectedly.

Controls in detail

Driving systems

Offset driving

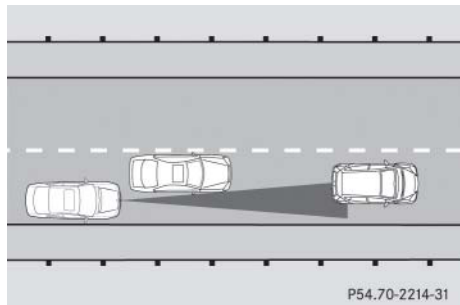

A vehicle traveling in your lane but offset from your direct line of travel may not be detected by Distronic. There will be insufficient distance to the vehicle ahead.

Lane changing

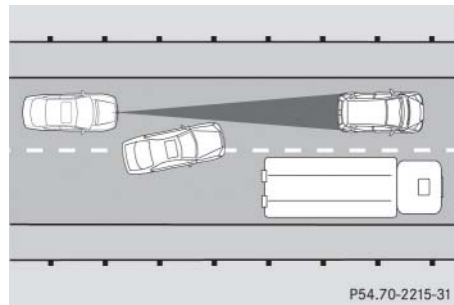

Distronic has not yet detected the vehicle changing lanes. There will be insufficient distance to the lane changing vehicle.

Narrow vehicles

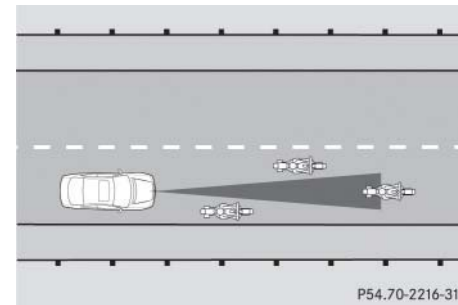

Because of its narrow profile, the vehicle traveling near the edge of the roadway has not yet been detected by Distronic. There will be insufficient distance to the vehicle ahead.

Parktronic (Parking assist)*

Warning!



Parktronic is a supplemental system. It is not intended to, nor does it replace, the need for extreme care. The responsibility during parking and other critical maneuvers always rests with the driver.

Special attention must be paid to objects with smooth surfaces or low silhouettes (e.g. trailer couplings, painted posts or road curbs). Such objects may not be detected by the system and can damage the vehicle.

The operational function of the Parktronic system can be affected by dirty sensors, especially at times of snow and ice, see "Cleaning the Parktronic* system sensors" (▷ page 301).

Interference caused by other ultrasonic signals (e.g. working jackhammers or the air brakes of trucks) can cause the system to send erratic indications, and should be taken into consideration.

Warning!



Make sure no persons or animals are in the area in which you are maneuvering. You could otherwise injure them.

The Parktronic system is an electronic aid designed to assist the driver during parking maneuvers. It visually and audibly indicates the relative distance between the vehicle and an obstacle.

The Parktronic system is automatically activated when you switch on the ignition and release the parking brake. The Parktronic system deactivates at speeds over approximately 11 mph (18 km/h). At lower speeds the Parktronic system turns on again.

Controls in detail

Driving systems

The Parktronic system monitors the surroundings of your vehicle with six sensors in the front bumper and four sensors in the rear bumper.

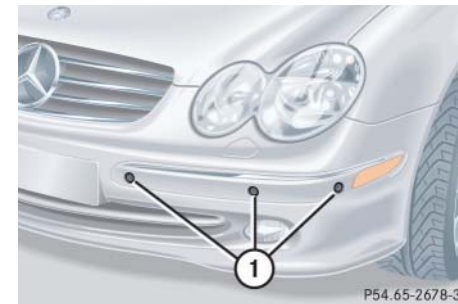

① Sensors in the front bumper

Controls in detail

Driving systems

Range of the sensors

To function properly, the sensors must be free of dirt, ice, snow and slush. Clean the sensors regularly, being careful not to scratch or damage the sensors.

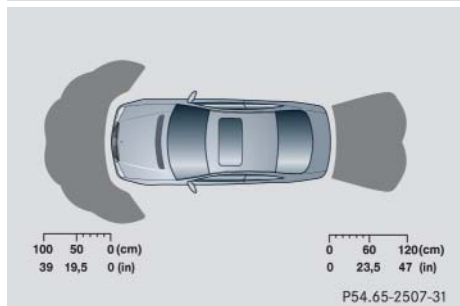
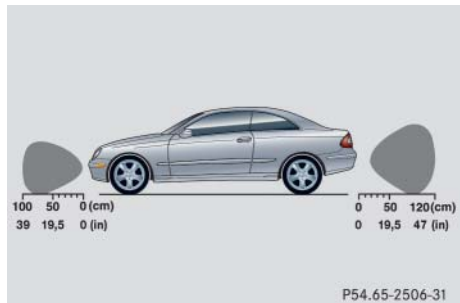

Front sensors

Center	approx. 39 in (100 cm)
Corners	approx. 23,5 in (60 cm)

Rear sensors

Center	approx. 47 in (120 cm)
Corners	approx. 32 in (80 cm)



During parking maneuvers, pay special attention to objects located above or below the height of the sensors (e.g. planters or trailer hitches). The Parktronic system will not detect such objects at close range and damage to your vehicle or the object may result.

Ultrasonic signals from outside sources (e.g. truck air brakes or jackhammers) may impair the operation of the Parktronic system.

Minimum distance

Center	approx. 8 in (20 cm)
Corners	approx. 6 in (15 cm)

If the system encounters an obstacle in this range, all the warning lamps come on and you hear a warning signal. If the obstacle is closer than the minimum distance, the actual distance may no longer be indicated by the system.

Warning indicators

Visual signals indicate to the driver the relative distance between the sensors and an obstacle. The warning indicator for the front area is located above the center air vents in the dashboard. The warning indicator for the rear area is integrated in the rear dome lighting.

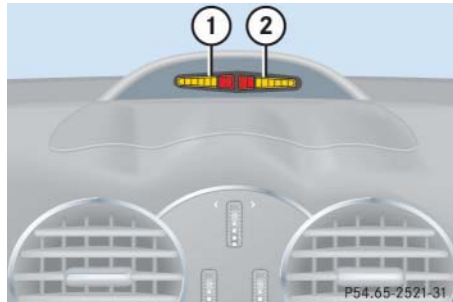

Front area warning indicator

- ① Left side of the vehicle
- ② Right side of the vehicle

Each warning indicator is divided into six yellow and two red segments for either side of the vehicle. The Parktronic system is ready when the border around the indicator is illuminated.

The position of the gear selector lever determines which warning indicators will be activated.

Gear selector lever position	Warning indicator
D	Front area activated
R or N	Front and rear area activated
P	Neither activated

As your vehicle approaches an object, one or more segments will come on, depending on the distance. When the eighth segment comes on, you have reached the minimum distance.

- **Front area:** An intermittent acoustic warning will sound as the first red segment comes on and a constant acoustic warning lasting a maximum of three seconds will sound for the second red segment. The signal is canceled when the gear selector lever is placed in position **P**.
- **Rear area:** An intermittent acoustic warning will sound as the first red segment comes on and a constant acoustic warning lasting a maximum of three seconds will sound for the second red segment. The signal is canceled when the gear selector lever is placed in position **D** or **P**.

Controls in detail

Driving systems

Switching the Parktronic system on/off

You can switch off the Parktronic system manually.

The Parktronic switch is located in the center console.

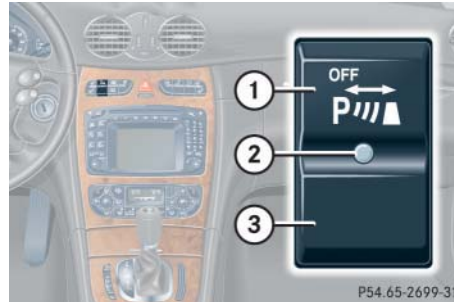

- ① Parktronic off
- ② Indicator lamp
- ③ Parktronic on

Switching off the Parktronic system

- ▶ Press upper half ① of the switch.
Indicator lamp ② comes on.

Switching on the Parktronic system

- ▶ Press lower half ③ of the switch.
Indicator lamp ② goes out.

▼ Loading

Roof rack

Warning!



Only use roof racks approved by Mercedes-Benz for your vehicle model to avoid damage to the vehicle. Follow manufacturer's installation instructions.

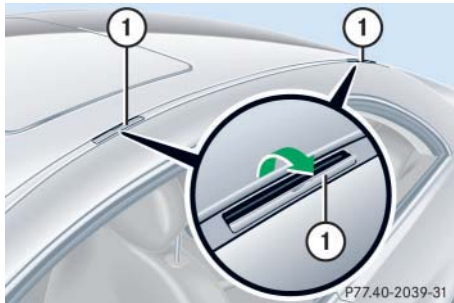

① Trim

Preparing roof rack installation

- ▶ Open trim ① at the trim strips in the roof.
- ▶ Secure the roof rack according to manufacturer's instructions for installation.



Load the roof rack in such a way that the vehicle cannot be damaged while driving.

Make sure

- you can fully raise the sliding/pop-up roof*
- you can fully open the trunk

Controls in detail

Loading

Ski sack*



- ① Handle
- ② Cover
- ③ Armrest

Unfolding and loading

- ▶ Fold armrest ③ down (arrow).
- ▶ Pull handle ① and swing cover ② down.



Controls in detail

Loading



④ Velcro strap

- ▶ Unfasten velcro strap ④.
- ▶ Pull ski sack into passenger compartment and unfold.



⑤ Button

- ▶ Open trunk lid.
- ▶ Press button ⑤.
The flap opens downward.



- ▶ From trunk, slide skis into ski sack.

Warning!



The ski sack is designed for up to four pairs of skis. Do not load the ski sack with other objects.

Always fasten the ski sack securely. In an accident, an unfastened ski sack can cause injury to vehicle occupants.

Controls in detail

Loading



⑥ Strap

- ▶ Tighten strap ⑥ by pulling at the loose end (arrow) until the skis in the ski sack are tightly secured.

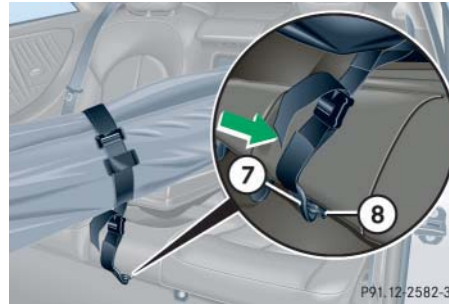

⑦ Hook

⑧ Eye

- ▶ Connect hook ⑦ to eye ⑧ located on center tunnel in front of rear seat bench.
- ▶ Tighten strap by pulling at the loose end (arrow).

Unloading and folding

- ▶ Loosen both straps.
- ▶ Disconnect hook ⑦ from eye ⑧.
- ▶ Unload skis.
- ▶ Close flap in trunk.
- ▶ Fold and flatten ski sack lengthwise.
- ▶ Place folded ski sack inside recess of backrest.
- ▶ Fasten velcro strap



- ▶ Close ski sack compartment cover.

Controls in detail

Loading

Removal of ski sack

You can remove the ski sack for cleaning or drying.

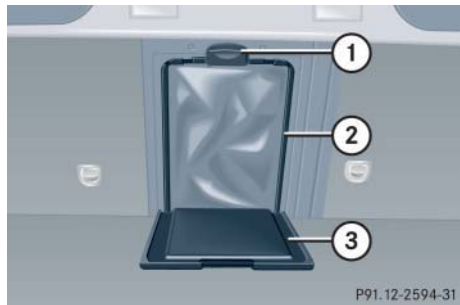

- ① Button
- ② Ski sack frame
- ③ Flap

- ▶ Open trunk lid.
- ▶ Press button ①.
- ▶ The flap ③ opens downward.
- ▶ Press button ① firmly until ski sack frame ② is released.
- ▶ Pull ski sack frame ② with ski sack out.

Warning!



Never drive vehicle with trunk open while the ski sack is removed. Deadly carbon monoxide (CO) gases may enter vehicle interior, resulting in unconsciousness and death.



To prevent unauthorized persons from access to the trunk, always close the flap.

Installing the ski sack

Install the ski sack in the reverse order.

- ▶ Push ski sack frame ② with ski sack inward until the ski sack frame snaps into place.
- ▶ Close flap ③.
- ▶ Close trunk lid.

Split rear bench seat

To expand the cargo area, you can fold down the left and right rear seat backrests. The two sections can be folded down separately.

Warning!



When expanding the luggage compartment, always fold the seat cushions fully forward. Unless you are transporting cargo, the backrests must remain properly locked in the upright position.

In an accident, during hard braking or sudden maneuvers, loose items will be thrown around inside the vehicle, and cause injury to vehicle occupants unless the items are securely fastened in the vehicle.

Always use the cargo tie down rings (▷ page 243).

Folding the backrest forward

The release handle ① is located in the trunk.



- ▶ Pull release handle ①.
- ▶ Fully retract and fold rearward head restraint (▷ page 110).

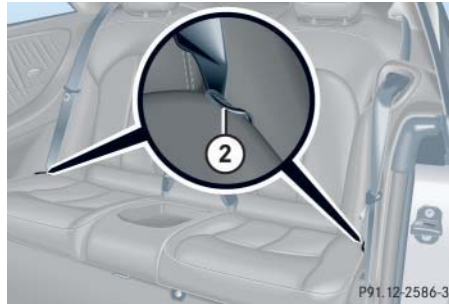

- ▶ Pull release handle ②.

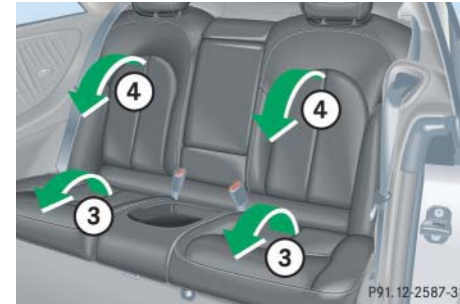

- ▶ Fold seat cushion ③ forward.
- ▶ Fold rear seat backrests ④ forward.

Controls in detail

Loading

Setting up rear seat bench



- ▶ Fold backrest ④ rearward until it engages.
- ▶ Fold seat cushions ③ rearward until it locks into position.

If a backrest is not locked into position, a red indicator ⑤ or ⑥ will be visible.

- ▶ Check for secure locking by pushing and pulling on the backrest.

Warning!



If a red indicator is visible with the backrest up, then the backrest is not properly locked into position.

Always lock backrest in its upright position when rear seat bench is occupied, or the extended trunk compartment is not in use. Check for secure locking by pushing and pulling on the backrest.

In an accident, during hard braking or sudden maneuvers, loose items will be thrown around inside the vehicle, and cause injury to vehicle occupants unless the items are securely fastened in the vehicle.

To help avoid personal injury during a collision or sudden maneuver, exercise care when transporting cargo.



To prevent unauthorized persons from access to the trunk, always lock backrest in its upright position.

Loading instructions

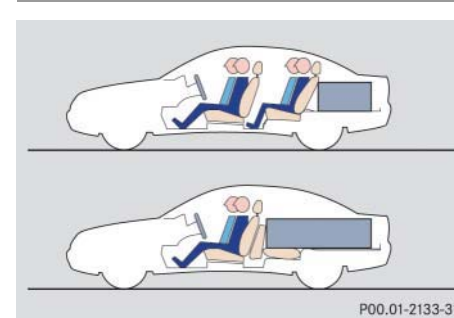

The total load weight including vehicle occupants and luggage/cargo should not exceed the vehicle capacity weight indicated on the certification tag which can be found on the left door pillar.

The handling characteristics of a fully loaded vehicle depend greatly on the load distribution. It is therefore recommended to load the vehicle according to the illustrations shown, with the heaviest items being placed towards the front of the vehicle.

Always place items being carried against front or rear seat backrests, and fasten them as securely as possible.

The heaviest portion of the cargo should always be kept as low as possible since it influences the handling characteristics of the vehicle.

Warning!



Always fasten items being carried as securely as possible.

In an accident, during hard braking or sudden maneuvers, loose items will be thrown around inside the vehicle and can cause injury to vehicle occupants unless the items are securely fastened in the vehicle.

To help avoid personal injury during a collision or sudden maneuver, exercise care when transporting cargo. Put luggage or cargo in the trunk if possible. Do not pile luggage or cargo higher than the seat backs. Do not place anything on the rear-window shelf.

Never drive vehicle with trunk open. Deadly carbon monoxide (CO) gases may enter vehicle interior resulting in unconsciousness and death.

Controls in detail

Loading

Cargo tie-down rings



Four rings are located in the cargo compartment.

- Carefully secure cargo by applying even load on all rings with rope of sufficient strength to hold down the cargo.

Always follow loading instructions (▷ page 242).

Controls in detail

Useful features

▼ Useful features

Interior storage spaces

Warning!



To help avoid personal injury during a collision or sudden maneuver, exercise care when stowing objects in the vehicle. Put luggage or cargo in the cargo compartment if possible. Do not pile luggage or cargo higher than the seat backs.

Luggage nets cannot secure hard or heavy objects.

Keep compartment lids closed. This will help to prevent stored objects from being thrown about and injuring vehicle occupants during an accident.

Glove box

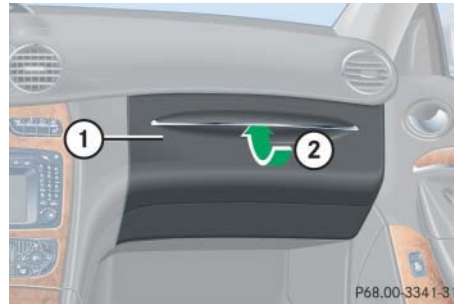

- ① Glove box
- ② Glove box lid release

Opening the glove box

- ▶ Pull lid release ②.
The glove box lid opens downward.

Closing the glove box

- ▶ Push lid up to close.



The glove box lid contains a compartment for eyeglasses.

Close the compartment for glasses first before closing the glove box.

Audio system/COMAND* with CD changer*: The CD changer is located in the glove box.

Cup holder in the dashboard

Warning!



When not in use, keep the cup holder closed. Place only containers that fit into the cup holder to prevent spills. Use lids on open containers and do not fill containers to a height where the contents, especially hot liquids, could spill during vehicle maneuvers.

Opening cup holder

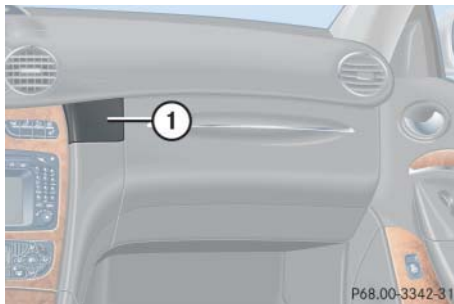

- ▶ Push cover ①.

The cup holder opens automatically.

Closing cup holder

- ▶ Push the cup holder back until it engages.

Cup holder in rear seat armrest

Warning!



When not in use, keep the cup holder closed. Place only containers that fit into the cup holder to prevent spills. Use lids on open containers and do not fill containers to a height where the contents, especially hot liquids, could spill during vehicle maneuvers.

Controls in detail

Useful features



Opening cup holder

- ▶ Push front of sliding compartment ①.
The cup holder slides out.

Closing cup holder

- ▶ Push sliding compartment ① back until it engages.

Controls in detail

Useful features

Armrest storage space

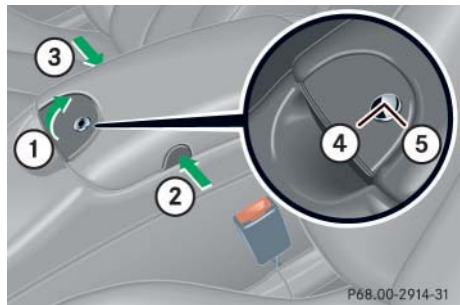

Opening compartment in armrest

- ▶ Lift armrest by pulling on handle ①.

Closing

- ▶ Lower armrest until it locks into place.



Do not store any items between the telephone holder and the cover for the blower. Otherwise these items could be damaged when the holder is closed. Use the space in the front door pocket for stowing.

Opening telephone compartment

- ▶ Lift armrest by pushing button ② or ③.

Closing telephone compartment

- ▶ Lower armrest until it locks into place.

Locking compartment

- ▶ Remove the mechanical key from the SmartKey (> page 343).
- ▶ Turn the compartment lock to position ⑤.

Unlocking compartment

- ▶ Turn the compartment lock to position ④.
- ▶ Insert the mechanical key in the SmartKey.

Changing inclination of armrest

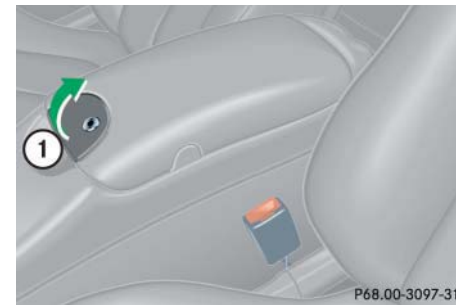

- ▶ Pull up on armrest.

Lowering armrest

- ▶ Pull handle ① to lower armrest.

Storage bags

Storage bags are located on the rear side of the front seats.

Warning!



Do not place heavy or fragile objects, or objects having sharp edges, in the storage bags.

In an accident, during hard braking or sudden maneuvers, they could be thrown around inside the vehicle, and cause injury to vehicle occupants.

Parcel net in front passenger footwell

A small convenience parcel net is located in the front passenger footwell. It is for small and light items, such as road maps, mail, etc.

Warning!



Do not place heavy or fragile objects, or objects having sharp edges, in the parcel net.

In an accident, during hard braking or sudden maneuvers, they could be thrown around inside the vehicle, and cause injury to vehicle occupants.

Controls in detail

Useful features

Ashtrays

Center console ashtray



Opening ashtray

- ▶ Briefly touch cover plate ①.
The ashtray opens automatically.

Controls in detail

Useful features

Removing ashtray insert

Warning!



Remove front ashtray only with vehicle standing still. Set the parking brake to secure vehicle from movement. Move gear selector lever to position **N**. With gear selector lever in position **N**, turn off the engine.

- ▶ Secure vehicle from movement by setting the parking brake. Move the gear selector lever to position **N**.

Now you have more room to take out the insert.

- ▶ Push sliding button ② to the right. The ashtray is disengaged and slides a short way in direction of arrow ③.
- ▶ Remove insert from ashtray frame.

Reinstalling the ashtray insert

- ▶ Install insert by pushing back into frame until it engages again.

Rear seat ashtray



Opening ashtray

- ▶ Pull at top of cover to open ashtray.

Removing ashtray insert

- ▶ Press latch ① to disengage ashtray insert and remove it.

Reinstalling the ashtray insert

- ▶ Install ashtray insert.
- ▶ Close the ashtray.

Cigarette lighter



- ① Cover
- ② Cigarette lighter

- ▶ Turn SmartKey in the starter switch to position **1** or **2**.

- ▶ Briefly touch cover plate ①.
- ▶ Push in cigarette lighter ②.

The lighter will pop out automatically when hot.

Warning!



Never touch the heating element or sides of the lighter; they are extremely hot. Hold the knob only.

When leaving the vehicle, always remove the SmartKey from the starter switch, take the SmartKey with KEYLESS-GO* with you and lock the vehicle. Do not leave children unattended in the vehicle, or with access to an unlocked vehicle. Unsupervised use of vehicle equipment may cause an accident and/or serious personal injury.



The lighter socket can be used to accommodate electrical accessories up to a maximum 85 W.

Floormats*

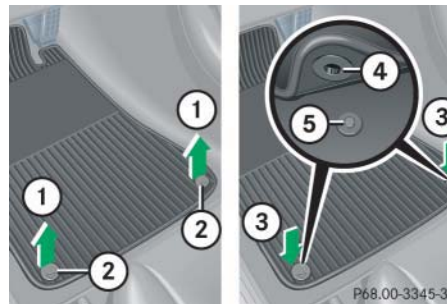

Removing

- ▶ Pull floormats off of retainer pins ② in direction of arrow ①.
- ▶ Remove the floormats.

Installing

- ▶ Lay down the floormat.
- ▶ Press the floormat eyelets ④ onto retainer pins ⑤ in direction of arrow ③.

Warning!



Whenever you are using floormats, make sure there is enough clearance and that the floormats are securely fastened.

Floormats should always be securely fastened using eyelets ④ and retainer pins ⑤.

Before driving off, check that the floormats are securely in place and adjust them if necessary. A loose floormat could slip and hinder proper functioning of the pedals.

Controls in detail

Useful features

Telephone*

Warning!



Never operate radio transmitters equipped with a built-in or attached antenna (i.e. without being connected to an external antenna) from inside the vehicle while the engine is running. Doing so could lead to a malfunction of the vehicle's electronic system, possibly resulting in an accident and/or serious personal injury.

Radio transmitters, such as a portable telephone or a citizens band unit, should only be used inside the vehicle if they are connected to an antenna that is installed on the outside of the vehicle.

The external antenna must be approved by Mercedes-Benz. Please contact an authorized Mercedes-Benz Center for information on the installation of an approved external antenna. Refer to the radio transmitter operation instructions regarding use of an external antenna.

Warning!





Please do not forget that your primary responsibility is to drive the vehicle. A driver's attention to the road must always be his/her primary focus when driving. For your safety and the safety of others, we recommend that you pull over to a safe location and stop before placing or taking a telephone call.

If you choose to use the telephone¹ while driving, please use the hands-free device and only use the telephone when road, traffic and weather conditions permit. Some jurisdictions prohibit the driver from using a cellular telephone while driving a vehicle.

Only operate the COMAND* (Cockpit Management and Data System)¹ if road, traffic and weather conditions permit.

¹ Observe all legal requirements.

Bear in mind that at a speed of just 30 mph (approximately 50 km/h), your vehicle is covering a distance of approx. 44 feet (approximately 13.5 m) every second.

You can take and place telephone calls using the  and  buttons on the steering wheel. To carry out other telephone functions, use the control system (▷ page 154).

See separate operating manual for instructions on how to use the telephone.

Tele Aid



The initial activation of the Tele Aid system may only be performed by completing the subscriber agreement and placing an acquaintance call using the SOS button. Failure to complete either of these steps will result in a system that is not activated. If the system is not activated, the indicator lamp in the SOS button stays on after turning SmartKey in starter switch to position **2** or pressing KEYLESS-GO* start/stop button twice to position **2** (▷ page 33). The message *Tele Aid not activated* will be shown in the multifunction display for approximately ten seconds.

If you have any questions regarding activation, please call the Response Center at 1-800-756-9018 (in the USA) or 1-888-923-8367 (in Canada).

The Tele Aid system



(Telematic Alarm Identification on Demand)

The Tele Aid system consists of three types of response:

- automatic and manual emergency
- roadside assistance and
- information

The Tele Aid system is operational providing that the vehicle's battery is charged, properly connected, not damaged and cellular and GPS coverage is available.

The speaker volume of a Tele Aid call can be adjusted when using the volume control on the multifunction steering wheel. To raise, press button **+** and to lower, press button **-**.



- ▶ To activate, press the SOS button, the Roadside Assistance button  or the Information button , depending on the type of response required.

Controls in detail

Useful features



The SOS button is located above the interior rear view mirror.

The Roadside Assistance button  and the Information button  are located below the center armrest cover.

Shortly after the completion of your Tele Aid acquaintance call, you will receive a user ID and password via first call mail. By visiting www.mbusa.com and selecting "Tele Aid" (USA only), you will have access to account information, remote door unlock, Info Services profile and more.





The Tele Aid system utilizes the cellular network for communication and the GPS (Global Positioning System) satellites for vehicle location. If either of these signals is unavailable, the Tele Aid system may not function and if this occurs, assistance must be summoned by other means.

Controls in detail

Useful features

System self-check

Initially, after turning the ignition (position **2**) on, malfunctions are detected and indicated (the indicator lamps in the SOS button, the Roadside Assistance button  and the Information button  stay on longer than ten seconds or do not come on). The message *Tele Aid defective! Visit workshop!* appears for approximately ten seconds in the multifunction display.



The Tele Aid system utilizes the cellular network for communication and the GPS (Global Positioning System) satellites for vehicle location. If either of these signals is unavailable, the Tele Aid system may not function and if this occurs, assistance must be summoned by other means.

Warning!



If the indicator lamps in the SOS button, in the Roadside Assistance button and/or in the Information button remain illuminated constantly in red and/or message *Tele Aid defective! Visit workshop!* is displayed in the multifunction display after the system self-check, a malfunction in the system has been detected.

If a malfunction is indicated as outlined above, the system may not operate as expected. Have the system checked at the nearest Mercedes-Benz Center as soon as possible.

Emergency calls

An emergency call is initiated automatically:

- following an accident in which the emergency tensioning devices (ETDs) or airbags deploy
- if the anti-theft alarm or the tow-away alarm stays on for more than 20 seconds, see “Anti-theft systems” (▷ page 81) and see “Tow-away alarm” (▷ page 83).

An emergency call can also be initiated manually by opening the cover next to the interior rear view mirror labeled SOS, then briefly pressing the button located under the cover. See below for instructions on initiating an emergency call manually.

Once the emergency call is in progress, the indicator lamp in the SOS button will begin to flash. The message *Emergency call - Connecting call* appears in the multifunction display.

When the connection is established, the message *Emergency call - Call connected* appears in the multifunction display. All information relevant to the emergency, such as the location of the vehicle (determined by the GPS satellite location system), vehicle model, identification number and color are generated.

A voice connection between the Response Center and the occupants of the vehicle will be established automatically soon after the emergency call has been initiated. When a voice connection is established, the audio system mutes and the message *Tele Aid - Emergency call active* appears in the multifunction display. The Response Center will attempt to determine more precisely the nature of the accident provided they can speak to an occupant of the vehicle.

The Tele Aid system is available if:

- it has been activated and is operational. Activation requires a subscription for monitoring services, connection and cellular air time
- the relevant cellular phone network and GPS signals are available and pass the information on to the response center



Location of the vehicle on a map is only possible if the vehicle is able to receive signals from the GPS satellite network and pass the information on to the response center.

Controls in detail

Useful features

Warning!



If the indicator lamp in the SOS button is illuminated continuously and there was no voice connection to the Response Center established, then the Tele Aid system could not initiate an emergency call (e.g. the relevant cellular phone network is not available). The message *Emergency call - Call failed* appears in the multifunction display for approximately ten seconds.

Should this occur, assistance must be summoned by other means.

Controls in detail

Useful features

Initiating an emergency call manually



- ① Cover
- ② SOS button

- ▶ Briefly press on cover ①.
The cover will open.
- ▶ Press SOS button ② briefly.
The indicator lamp in SOS button ② will flash until the emergency call is concluded.

- ▶ Wait for a voice connection to the Response Center.
- ▶ Close cover ① after the emergency call is concluded.

Warning!



If you feel at any way in jeopardy when in the vehicle (e.g. smoke or fire in the vehicle, vehicle in a dangerous road location), please do not wait for voice contact after you have pressed the emergency button. Carefully leave the vehicle and move to a safe location. The Response Center will automatically contact local emergency officials with the vehicle's approximate location if they receive an automatic SOS signal and cannot make voice contact with the vehicle occupants.

Roadside Assistance button

The Roadside Assistance button  is located below the center armrest cover.

- ▶ Press and hold the button (for longer than two seconds).

A call to a Mercedes-Benz Roadside Assistance dispatcher will be initiated. The button will flash while the call is in progress. The message *Roadside Assistance - Connecting call* will appear in the multifunction display.

When the connection is established, the message *Roadside Assistance - Call connected* appears in the multifunction display. The Tele Aid system will transmit data generating the vehicle identification number, model, color and location (subject to availability of cellular and GPS signals).

Controls in detail

Useful features

A voice connection between the Roadside Assistance dispatcher and the occupants of the vehicle will be established. When a voice connection is established, the audio system mutes and the message *Tele Aid - Roadside Assistance call active* appears in the multifunction display.



- Describe the nature of the need for assistance.

The Mercedes-Benz Roadside assistance dispatcher will either dispatch a qualified Mercedes-Benz technician or arrange to tow your vehicle to the nearest authorized Mercedes-Benz Center. For services such as labor and/or towing, charges may apply. Refer to the Roadside Assistance manual for more information.

These programs are only available in the USA:

- Sign and Drive services: Services such as jump start, a few gallons of fuel or the replacement of a flat tire with the vehicle spare tire are obtainable.
- Remote Vehicle Diagnostics: This function permits the Mercedes-Benz Roadside Assistance dispatcher to download malfunction codes and actual vehicle data.



The indicator lamp on the Roadside Assistance button  remains illuminated in red for approximately ten seconds during the system self-check after turning the ignition (position **2**) on (together with the SOS button and the Information button ).

See system self-check (► page 252) when the indicator lamp does not come on in red or stays on longer than approximately ten seconds.

If the indicator lamp on the Roadside Assistance button  is illuminated continuously and there was no voice connection to the Response Center established, then the Tele Aid system could not initiate a Roadside Assistance call (e.g. the relevant cellular phone network is not available). The message *Roadside Assistance - Call failed* appears in the multifunction display.

Roadside Assistance calls can be terminated using the  button on the multifunction steering wheel.

Controls in detail

Useful features

Information button

The Information button  is located below the center armrest cover.

- ▶ Press and hold the button (for longer than two seconds).

A call to the Customer Assistance Center will be initiated. The button will flash while the call is in progress. The message *Info - Connecting call* will appear in the multifunction display.



When the connection is established, the message *Info - Call connected* appears in the multifunction display. The Tele Aid system will transmit data generating the vehicle identification number, model, color and location (subject to availability of cellular and GPS signals).

A voice connection between the Customer Assistance Center representative and the occupants of the vehicle will be established. When a voice connection is established, the audio system mutes and the message *Tele Aid - Info call active* appears in the multifunction display. Infor-

mation regarding the operation of your vehicle, the nearest authorized Mercedes-Benz Center or Mercedes-Benz USA products and services is available to you.

For more details concerning the Tele Aid system, please visit www.mbusa.com and use your ID and password (sent to you separately) to learn more (USA only).



The indicator lamp on the Information button  remains illuminated in red for approximately ten seconds during the system self-check after turning the ignition (position **2**) on (together with the SOS button and the Roadside Assistance button ).

See System self-check (▶ page 252) when the indicator lamp does not come on in red or stays on longer than approximately ten seconds.

If the indicator lamp on the Information button  is illuminated continuously and there was no voice connection to the Response Center established, then the Tele Aid system could not initiate an Information call (e.g. the relevant cellular phone network is not available). The message *Info - Call failed* appears in the multifunction display.

Information calls can be terminated using the  button on the multifunction steering wheel.



If the indicator lamps do not start flashing after pressing one of the buttons or remain illuminated (in red) at any time, the Tele Aid system has detected a fault or the service is not currently active, and may not initiate a call. Visit your authorized Mercedes-Benz Center and have the system checked or contact the Response Center at 1-800-756-9018 (in the USA) or 1-888-923-8367 (in Canada) as soon as possible.

Upgrade signals

The Tele Aid system processes calls using the following priority.

- Automatic emergency – First priority
- Manual emergency – Second priority
- Roadside assistance – Third priority
- Information – Fourth priority

Should a higher priority call be initiated while you are connected, an upgrade (alternating) tone will be heard, and the appropriate indicator lamp will flash. If certain information such as vehicle identification number or customer information is not available, the operator may need to retransmit.

During this time you will hear a beep and voice contact will be interrupted. Voice contact will resume once the retransmission is completed. Once a call is concluded, a beep will be heard and the respective indicator lamp will stop flashing. The COMAND* system operation will resume.

Controls in detail

Useful features



If the indicator lamp continues to flash or the system does not reset, contact the Response Center at 1-800-756-9018 (in the USA) or 1-888-923-8367 (in Canada), or Mercedes-Benz Customer Assistance at 1-800-FOR-MERCEdes (1-800-367-6372) in the USA or Customer Service at 1-800-387-0100 in Canada.



The indicator lamp in the respective button flashes until the call is concluded. Calls can only be terminated by a Response Center or Customer Assistance Center representative except Roadside Assistance and Information calls, which can also be terminated by pressing button  on the multifunction steering wheel.

Controls in detail

Useful features



When a Tele Aid call has been initiated, the audio system or the COMAND* system audio is muted and the selected mode (radio, tape or CD) pauses. The optional cellular phone (if installed) switches off. If you must use this phone, the vehicle must be parked. Disconnect the coiled cord and place the call. The COMAND* navigation system (if engaged) will continue to run. The display in the instrument cluster is available for use and spoken commands are only available by pressing the RPT button on the COMAND* unit. A pop-up window will appear in the COMAND* display to indicate that a Tele Aid call is in progress.

Remote door unlock

In case you have locked your vehicle unintentionally (e.g. SmartKey inside vehicle), and the reserve SmartKey is not handy:

- ▶ Contact the Mercedes-Benz Response Center at 1-800-756-9018 (in the USA) or 1-888-923-8367 (in Canada).

You will be asked to provide your password which you provided when you completed the subscriber agreement.

- ▶ Then return to your vehicle and pull the trunk recessed handle for a minimum of 20 seconds until the SOS button is flashing.

The message *Emergency call - Call connected* appears in the multifunction display.

As an alternative, you may unlock the vehicle via Internet using the ID and password sent to you shortly after the completion of your acquaintance call.

The Response Center will then unlock your vehicle with the remote door unlocking feature.



The remote door unlock feature is available if the relevant cellular phone network is available.

The SOS button will flash and the message *Emergency call - Call connected* will appear in the multifunction display to indicate receipt of the door unlock command.

Once the vehicle is unlocked, a Response Center specialist will attempt to establish voice contact with the vehicle occupants.

If the trunk recessed handle was pulled for more than 20 seconds before door unlock authorization was received by the Response Center, you must wait 15 minutes before pulling the trunk recessed handle again.

Stolen vehicle tracking services

In the event your vehicle was stolen:

- ▶ Report the incident to the police.
The police will issue a numbered incident report.
- ▶ Pass this number on to the Mercedes-Benz Response Center along with your password issued to you when you subscribed to the service.

The Response Center will then attempt to covertly contact the vehicle's Tele Aid system. Once the vehicle is located, the Response Center will contact the local law enforcement and you. The vehicle's location will only be provided to law enforcement.

Garage door opener

The built-in remote control is capable of operating up to three separately controlled devices, for example garage door openers, gate openers, or other devices compatible with HomeLink® or some other systems.

You can program the signal transmitter buttons.

Controls in detail

Useful features

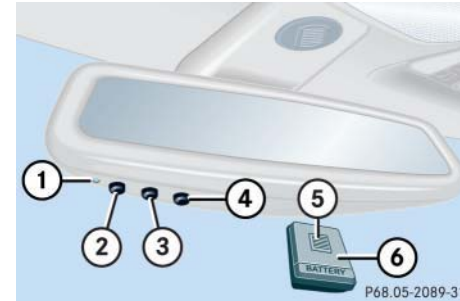

Remote control integrated into the interior rear view mirror

- ① Indicator lamp
- ② ③ ④ Signal transmitter button
- ⑤ Hand-held transmitter button
- ⑥ Hand-held remote control transmitter (not part of the vehicle equipment)

Controls in detail

Useful features

Warning!



Before programming the integrated remote control to a garage door opener or gate operator, make sure that people and objects are out of the way of the device to prevent potential harm or damage.

When programming a garage door opener, the door moves up or down. When programming a gate operator, the gate opens or closes.

Do not use the integrated remote control with any garage door opener that lacks safety stop and reverse features as required by U.S. federal safety standards (this includes any garage door opener model manufactured before April 1, 1982). A garage door that cannot detect an object - signaling the door to stop and reverse - does not meet current U.S. federal safety standards.



Certain types of garage door openers are incompatible with the integrated opener. If you should experience difficulties with programming the transmitter, contact your authorized Mercedes-Benz Center, or call Mercedes-Benz Customer Assistance Center (in the USA only) at 1-800-FOR-MERCEdes, or Customer Service (in Canada) at 1-800-387-0100.



For operation in the USA only: This device complies with Part 15 of the FCC Rules. Operation is subject to the following two conditions:

- (1) This device may not cause harmful interference, and
- (2) this device must accept any interference received, including interference that may cause undesired operation.

Any unauthorized modification to this device could void the user's authority to operate the equipment.

Programming or reprogramming the integrated remote control

Step 1:

- ▶ Switch on ignition.

Step 2:

- ▶ If you have previously programmed an integrated signal transmitter button and wish to retain its programming, proceed to step 3. Otherwise, press and hold the two outer signal transmitter buttons ② and ④ and release them only when the indicator light begins to flash after approximately 20 seconds (do not hold the button for longer than 30 seconds). This procedure erases any previous settings for all three channels and initializes the memory. If you later wish to program a second and/or third hand-held transmitter to the remaining two signal transmitter buttons, do not repeat this step and begin directly with step 3.

Step 3:

- ▶ Hold the end of the hand-held remote control transmitter ⑥ of the device you wish to train approximately 2 to 5 in (5 to 12 cm) away from the surface of the integrated remote control located on the interior rear view mirror, keeping the indicator lamp ① in view.

Step 4:

- ▶ Using both hands, simultaneously press the hand-held transmitter button ⑤ and the desired integrated signal transmitter button (②, ③ or ④). Do not release the buttons until completing step 5.

The indicator lamp ① on the integrated remote control will flash, first slowly and then rapidly.

i

The indicator lamp ① flashes the first time the signal transmitter button is programmed. If this button has already been programmed, the indicator lamp will only start flashing after 20 seconds.

Step 5:

- ▶ When the indicator lamp ① flashes rapidly, release both buttons.

Step 6:

- ▶ Press and hold the just-trained integrated signal transmitter button and observe the indicator lamp ①.

If the indicator lamp ① stays on constantly, programming is complete and your device should activate when the integrated signal transmitter button is pressed and released.

Controls in detail

Useful features



If the indicator lamp ① blinks rapidly for about two seconds and then turns to a constant light, continue with programming steps 8 through 12 as your garage door opener may be equipped with the “rolling code” feature.

Step 7:

- ▶ To program the remaining two buttons, repeat the steps above starting with step 3.

Rolling code programming

To train a garage door opener (or other rolling code devices) with the rolling code feature, follow these instructions after completing the “Programming” portion (steps 1 through 6) of this text. (A second person may make the following training procedures quicker and easier.)

Step 8:

- ▶ Locate “training” button on the garage door opener motor head unit.

Exact location and color of the button may vary by garage door opener brand. Depending on manufacturer, the “training” button may also be referred to as “learn” or “smart” button. If there is difficulty locating the transmitting button, refer to the garage door opener operator’s manual.

Step 9:

- ▶ Press “training” button on the garage door opener motor head unit.

The “training light” is activated.

You have 30 seconds to initiate the following step.

Step 10:

- ▶ Firmly press, hold for two seconds and release the programmed integrated signal transmitter button (②, ③ or ④).

Step 11:

- ▶ Press, hold for two seconds and release same button a second time to complete the training process.

Some garage door openers (or other rolling code equipped devices) may require you to perform this procedure a third time to complete the training.

Controls in detail

Useful features

Step 12:

- ▶ Confirm the garage door operation by pressing the programmed integrated signal transmitter button (②, ③ or ④).

Step 13:

- ▶ To program the remaining two buttons, repeat the steps above starting with step 3.

Gate operator/Canadian programming

Canadian radio-frequency laws require transmitter signals to “time-out” (or quit) after several seconds of transmission which may not be long enough for the integrated signal transmitter to pick up the signal during programming. Similar to this Canadian law, some U.S. gate operators are designed to “time-out” in the same manner.

If you live in Canada or if you are having difficulties programming a gate operator (regardless of where you live) by using the programming procedures, replace step 4 with the following:

Step 4:

- ▶ Continue to press and hold the integrated signal transmitter button (②, ③ or ④) while you press and re-press (“cycle”) your hand-held remote control transmitter ⑥ every two seconds until the frequency signal has been learned. Upon successful training, the indicator lamp ① will flash slowly and then rapidly after several seconds.
- ▶ Proceed with programming step 5 and step 6 to complete.

Operation of integrated remote control

- ▶ Switch on ignition.
- ▶ Select and press the appropriate integrated signal transmitter button (②, ③ or ④) to activate the remote controlled device.

The integrated remote control transmitter continues to send the signal as long as the button is pressed – up to 20 seconds.

Controls in detail

Useful features

Erasing the integrated remote control memory

- ▶ Switch on ignition.
- ▶ Simultaneously hold down the signal transmitter buttons ② and ④, for approximately 20 seconds, until the indicator lamp ① blinks rapidly. Do not hold for longer than 30 seconds.

The codes of all three channels are erased.



If you sell your vehicle, erase the codes of all three channels.

Reprogramming a single integrated signal transmitter button

To program a device using a signal transmitter button previously trained, follow these steps:

- ▶ Press and hold the desired signal transmitter button (②, ③ or ④). Do not release the button.
- ▶ The indicator lamp will begin to flash after 20 seconds. Without releasing the integrated signal transmitter button, proceed with programming starting with step 3.

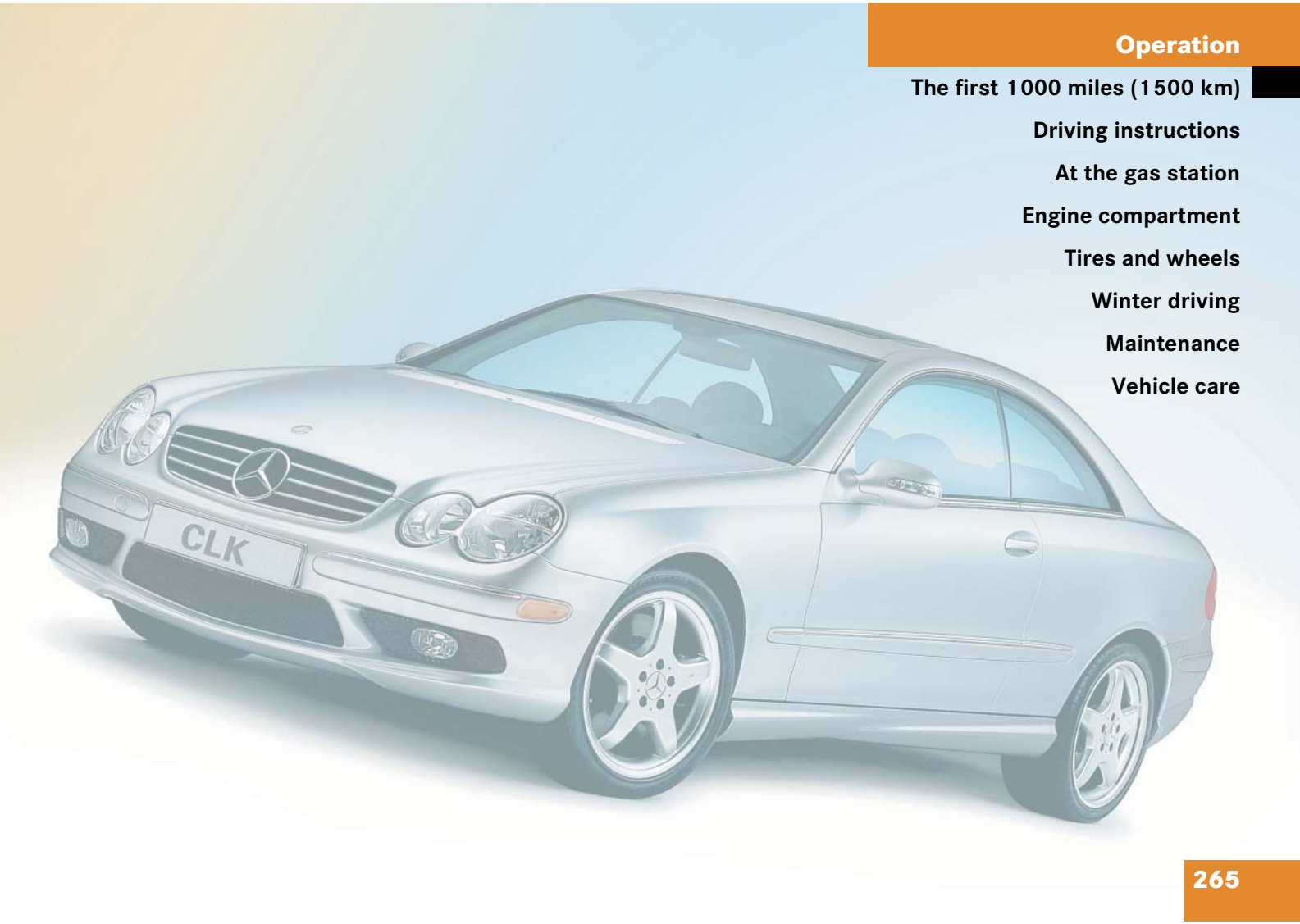

Operation

The first 1000 miles (1500 km)

Driving instructions

At the gas station

Engine compartment

Tires and wheels

Winter driving

Maintenance

Vehicle care

Operation

The first 1 000 miles (1 500 km)

In the “Operation” section you will find detailed information on operating, maintaining and caring for your vehicle.

▼ The first 1 000 miles (1 500 km)

The more cautiously you treat your vehicle during the break-in period, the more satisfied you will be with its performance later on.

- Drive your vehicle during the first 1 000 miles (1 500 km) at varying but moderate vehicle and engine speeds.
- During this period, avoid heavy loads (full throttle driving) and excessive engine speeds (no more than $\frac{2}{3}$ of maximum rpm in each gear).
- Avoid accelerating by kickdown.
- Do not attempt to slow the vehicle down by shifting to a lower gear using the gear selector lever.
- Select positions **3**, **2** or **1** only when driving at moderate speeds (for hill driving).



Additional instructions for AMG vehicles:

- During the first 1 000 miles (1 500 km), do not exceed a speed of 85 mph (140 km/h).
- During this period, avoid engine speeds above 4500 rpm in each gear.

All of the above instructions, as may apply to your vehicle type, also apply when driving the first 1 000 miles (1 500 km) after the engine or the rear differential has been replaced.

After 1 000 miles (1 500 km), you may gradually increase vehicle and engine speeds to the permissible maximum.



Always obey applicable speed limits.

▼ **Driving instructions**

Drive sensibly – save fuel

Fuel consumption, to a great extent, depends on driving habits and operating conditions.

To save fuel you should:

- Keep tires at the recommended inflation pressures.
- Remove unnecessary loads.
- Remove roof rack when not in use.
- Allow engine to warm up under low load use.
- Avoid frequent acceleration and deceleration.
- Have all maintenance work performed at the intervals specified in the Service Booklet and as required by the FSS. Contact your authorized Mercedes-Benz Center.

Fuel consumption is also increased by driving in cold weather, in stop-and-go traffic, on short trips and in hilly country.

Drinking and driving

Warning!



Drinking and driving and/or taking drugs and driving are very dangerous combinations. Even a small amount of alcohol or drugs can affect your reflexes, perceptions and judgement.

The possibility of a serious or even fatal accident are greatly increased when you drink or take drugs and drive.

Do not drink or take drugs and drive or allow anyone to drive who has been drinking or taking drugs.

Pedals

Warning!



Keep driver's foot area clear at all times. Objects stored in this area may impair pedal movement.

Power assistance

Warning!



With the engine not running, there is no power assistance for the brake and steering systems. In this case, it is important to keep in mind that a considerably higher degree of effort is necessary to brake and steer the vehicle.

Operation

Driving instructions

Brakes

Warning!



After driving in heavy rain for some time without applying the brakes or through water deep enough to wet brake components, the first braking action may be somewhat reduced and increased pedal pressure may be necessary to obtain expected braking effect. Maintain a safe distance from vehicles in front.

Resting your foot on the brake pedal will cause excessive and premature wear of the brake pads.

It can also result in the brakes overheating, thereby significantly reducing their effectiveness. It may not be possible to stop the vehicle in sufficient time to avoid an accident.

To help prevent brake disk corrosion after driving on wet road surfaces (particularly salted roads), it is advisable to brake the vehicle with considerable force prior to parking. The heat generated serves to dry the brakes.

If your brake system is normally only subject to moderate loads, you should occasionally test the effectiveness of the brakes by applying above-normal braking pressure at higher speeds. This will also enhance the grip of the brake pads.



Be very careful not to endanger other road users when you apply the brakes.

Refer to the description of the Brake Assist System (BAS) (> page 77).

If the parking brake is released and the brake warning lamp in the instrument cluster stays on, the brake fluid level in the reservoir is too low.

Brake pad wear or a leak in the system may be the reason for low brake fluid in the reservoir.

Have the brake system inspected immediately. Contact your authorized Mercedes-Benz Center.

All checks and service work on the brake system should be carried out by qualified technicians only. Contact your authorized Mercedes-Benz Center.

Only install brake pads and brake fluid recommended by Mercedes-Benz.

Warning!



If other than recommended brake pads are installed, or other than recommended brake fluid is used, the braking properties of the vehicle can be degraded to an extent that safe braking is substantially impaired. This could result in an accident.



When driving down long and steep grades, relieve the load on the brakes by shifting into a lower gear to use the engine's braking power. This helps prevent overheating of the brakes and reduces brake pad wear.

After hard braking, it is advisable to drive on for some time, rather than immediately parking, so that the air stream can cool down the brakes faster.

Driving off

Apply the brakes to test them briefly after driving off. Perform this procedure only when the road is clear of other traffic.

Warm up the engine gradually. Do not place full load on the engine until the operating temperature has been reached.

When starting off on a slippery surface, do not allow a drive wheel to spin for an extended period. Doing so may cause serious damage to the drive train which is not covered by the Mercedes-Benz Limited Warranty.



Simultaneously depressing the accelerator pedal and applying the brake reduces engine performance and causes premature brake wear and drivetrain wear.

Parking



Set the parking brake whenever parking or leaving the vehicle. In addition, move gear selector lever to position **P**. When parking on hills, turn front wheels towards the road curb.

Warning!



Do not park this vehicle in areas where combustible materials such as grass, hay or leaves can come into contact with the hot exhaust system, as these materials could be ignited and cause a vehicle fire.

Operation

Driving instructions

Warning!



To reduce the risk of personal injury as a result of inadvertent vehicle movement, before turning off the engine and leaving the vehicle always:

- Keep right foot firmly on brake pedal.
- Firmly depress parking brake pedal.
- Move the gear selector lever to position **P**.
- Slowly release brake pedal.
- When parked on an incline, turn front wheels towards the road curb.
- Turn the SmartKey to starter switch position **0** and remove, or press KEYLESS-GO* start/stop button (vehicles with KEYLESS-GO*).
- Take the SmartKey or the SmartKey with KEYLESS-GO* with you and lock vehicle when leaving.

Tires

Warning!



If you feel a sudden significant vibration or ride disturbance, or you suspect that possible damage to your vehicle has occurred, you should turn on the hazard warning flashers, carefully slow down, and drive with caution to an area which is a safe distance from the road.

Inspect the tires and the vehicle underbody for possible damage. If the vehicle or tires appear unsafe, have it towed to the nearest Mercedes-Benz Center or tire dealer for repairs.

Tread wear indicators (TWI) are required by law. These indicators are located in six places on the tread circumference and become visible at a tread depth of approximately $\frac{1}{16}$ in (1.6 mm), at which point the tire is considered worn and should be replaced.

The tread wear indicator appears as a solid band across the tread.

Warning!



Although the applicable federal motor vehicle safety laws consider a tire to be worn when the tread wear indicators (TWI) become visible at approximately $\frac{1}{16}$ in (1.6 mm), we recommend that you do not allow your tires to wear down to that level. As tread depth approaches $\frac{1}{8}$ in (3 mm), the adhesion properties on a wet road are sharply reduced.

Depending upon the weather and/or road surface (conditions), the tire traction varies widely.

Specified tire pressures must be maintained. This applies particularly if the tires are subject to extreme operating conditions (e.g. high speeds, heavy loads, high ambient temperatures).

Warning!

Do not drive with a flat tire. A flat tire affects the ability to steer or brake the vehicle. You may lose control of the vehicle. Continued driving with a flat tire or driving at high speed with a flat tire will cause excessive heat build-up and possibly a fire.

Hydroplaning

Depending on the depth of the water layer on the road, hydroplaning may occur, even at low speeds and with new tires. Reduce vehicle speed, avoid track grooves in the road and apply brakes cautiously in the rain.

Tire traction

The safe speed on a wet, snow covered or icy road is always lower than on a dry road. You should pay particular attention to the condition of the road whenever the outside temperatures are close to the freezing point.

Warning!

If ice has formed on the road, tire traction will be substantially reduced. Under such weather conditions, drive, steer and brake with extreme caution.

Mercedes-Benz recommends M+S rated radial-ply tires with a minimum tread depth of approximately $\frac{1}{6}$ in (4 mm) on all four wheels for the winter season to ensure normal balanced handling characteristics. On packed snow, they can reduce your stopping distance compared to summer tires. Stopping distance, however, is still considerably greater than when the road is not covered with snow or ice. Exercise appropriate caution.

Operation

Driving instructions

Tire speed rating

Regardless of the tire rating, local speed limits should be obeyed. Use prudent driving speeds appropriate to prevailing conditions.

Warning!



Even when permitted by law, never operate a vehicle at speeds greater than the maximum speed rating of the tires.

Exceeding the maximum speed for which tires are rated can lead to sudden tire failure, causing loss of vehicle control and possibly resulting in an accident and/or personal injury and possible death, for you and for others.

CLK 320

Your vehicle is factory equipped with “H”-rated tires, which have a speed rating of 130 mph (210 km/h) or with “W”-rated tires*, which have a speed rating of 168 mph (270 km/h).

An electronic speed limiter prevents your vehicle from exceeding a speed of 130 mph (210 km/h).

CLK 320 with Appearance Package*

Your vehicle is factory equipped with “W”-rated tires, which have a speed rating of 168 mph (270 km/h).

An electronic speed limiter prevents your vehicle from exceeding a speed of 130 mph (210 km/h).

CLK 500

Your vehicle is factory equipped with “Y”-rated tires, which have a speed rating of 186 mph (300 km/h).

An electronic speed limiter prevents your vehicle from exceeding a speed of 130 mph (210 km/h).

CLK 55 AMG

Your vehicle is factory equipped with “Y”-rated tires, which have a speed rating of 186 mph (300 km/h).

An electronic speed limiter prevents your vehicle from exceeding a speed of 155 mph (250 km/h).



For information on tire speed rating for winter tires, see “Winter tires” (▷ page 294).

Winter driving instructions

The most important rule for slippery or icy roads is to drive sensibly and to avoid abrupt acceleration, braking and steering maneuvers. Do not use the cruise control system under such conditions.

When the vehicle is in danger of skidding, move gear selector lever to position **N**. Try to keep the vehicle under control by corrective steering action.



For information on driving with snow chains, see “Snow chains” (▷ page 295).

Warning!



On slippery road surfaces, never downshift in order to obtain braking action. This could result in drive wheel slip and reduced vehicle control. Your vehicle’s ABS will not prevent this type of control loss.

Road salts and chemicals can adversely affect braking efficiency. Increased pedal force may become necessary to produce the normal braking effect.

Depressing the brake pedal periodically when traveling at length on salt-strewn roads can bring road-salt-impaired braking efficiency back to normal.

If the vehicle is parked after being driven on salt-treated roads, the braking efficiency should be tested as soon as possible after driving is resumed.

Warning



Make sure not to endanger any other road users when carrying out these braking maneuvers.

Operation

Driving instructions

Warning!



If the vehicle becomes stuck in snow, make sure snow is kept clear of the exhaust pipe and from around the vehicle with the engine running. Otherwise, deadly carbon monoxide (CO) gases may enter vehicle interior resulting in unconsciousness and death.

To assure sufficient fresh air ventilation, open a window slightly on the side of the vehicle not facing the wind.

Warning!



The outside temperature indicator is not designed to serve as an ice-warning device and is therefore unsuitable for that purpose. Indicated temperatures just above the freezing point do not guarantee that the road surface is free of ice.

For more information, see “Winter driving” (▷ page 294).

Operation

Driving instructions

Standing water



Do not drive through flooded areas or water of unknown depth. Before driving through water, determine its depth. Never accelerate before driving into water. The bow wave could force water into the engine and auxiliary equipment, thus damaging them.

If you must drive through standing water, drive slowly to prevent water from entering the passenger compartment or the engine compartment. Water in these areas could cause damage to electrical components or wiring of the engine or transmission, or could result in water being ingested by the engine through the air intake, causing severe internal engine damage. Any such damage is not covered by the Mercedes-Benz Limited Warranty.

Passenger compartment

Warning!



Always fasten items being carried as securely as possible.

In an accident, during hard braking or sudden maneuvers, loose items will be thrown around inside the vehicle, and cause injury to vehicle occupants unless the items are securely fastened in the vehicle.

The trunk is the preferred place to carry objects.

Driving abroad

Abroad, there is an extensive Mercedes-Benz service network at your disposal. If you plan to drive into areas which are not listed in the index of your Mercedes-Benz Center directory, you should request pertinent information from your authorized Mercedes-Benz Center.

Control and operation of radio transmitters

COMAND*, radio and telephone*

Warning!



Please do not forget that your primary responsibility is to drive the vehicle safely. Only operate the COMAND (Cockpit Management and Data System), radio or telephone¹ if road, traffic and weather conditions permit.

Bear in mind that at a speed of just 30 mph (approximately 50 km/h), your vehicle is covering a distance of approximately 44 feet (approximately 13.5 m) every second.

¹ Observe all legal requirements.

Telephones and two-way radios

Warning!



Never operate radio transmitters equipped with a built-in or attached antenna (i.e. without being connected to an external antenna) from inside the vehicle while the engine is running. Doing so could lead to a malfunction of the vehicle's electronic system, possibly resulting in an accident and/or serious personal injury.

Radio transmitters, such as a portable telephone or a citizens band unit should only be used inside the vehicle if they are connected to an antenna that is installed on the outside of the vehicle.

Refer to the radio transmitter operation instructions regarding use of an external antenna.

Catalytic converter

Your Mercedes-Benz is equipped with monolithic-type catalytic converters, an important element in conjunction with the oxygen sensors to achieve substantial control of the pollutants in the exhaust emissions. Keep your vehicle in proper operating condition by following our recommended maintenance instructions as outlined in your Service Booklet.



To prevent damage to the catalytic converters, only use premium unleaded gasoline in this vehicle.

Any noticeable irregularities in engine operation should be dealt with promptly. Otherwise, excessive unburned fuel may reach the catalytic converter, causing it to overheat and start a fire.

Operation

Driving instructions

Warning!



As with any vehicle, do not idle, park or operate this vehicle in areas where combustible materials such as grass, hay, or leaves can come into contact with the hot exhaust system, as these materials could be ignited and cause a vehicle fire.

Emission control

Certain systems of the engine serve to keep the toxic components of the exhaust gases within permissible limits required by law.

These systems, of course, will function properly only when maintained strictly according to factory specifications. Any adjustments to the engine should therefore be carried out only by qualified Mercedes-Benz Center authorized technicians.

Engine adjustments should not be altered in any way. Moreover, the specified service jobs must be carried out regularly according to Mercedes-Benz servicing requirements. For details refer to the Service Booklet.

Warning!



Inhalation of exhaust gas is hazardous to your health. All exhaust gas contains carbon monoxide, and inhaling it can cause unconsciousness and lead to death.

Do not run the engine in confined areas (such as a garage) which are not properly ventilated. If you think that exhaust gas fumes are entering the vehicle while driving, have the cause determined and corrected immediately. If you must drive under these conditions, drive with at least one window fully open at all times.

Coolant temperature

During severe operating conditions and stop-and-go city traffic, the coolant temperature may rise close to approx. 248°F (120°C).

The engine should not be operated with the coolant temperature over 248°F (120°C). Doing so may cause serious engine damage which is not covered by the Mercedes-Benz Limited Warranty.

Warning!



- Driving when your engine is badly overheated can cause some fluids, which may have leaked into the engine compartment, to catch fire. You could be seriously burned.
- Steam from an overheated engine can cause serious burns and can occur just by opening the hood. Stay away from the engine if you see or hear steam coming from it.

Turn off the engine, get out of the vehicle and do not stand near the vehicle until the engine has cooled down.

Operation

At the gas station

▼ At the gas station

Refueling

Warning!



Gasoline is highly flammable and poisonous. It burns violently and can cause serious injury. Whenever you are around gasoline, avoid inhaling fumes and skin contact, extinguish all smoking materials. Never allow sparks, flame or smoking materials near gasoline!

Failure to remove the fuel cap slowly could result in personal injury.

The fuel filler flap is located on the right-hand side of the vehicle towards the rear. Locking/unlocking the vehicle with the SmartKey or the SmartKey with KEYLESS-GO* automatically locks/unlocks the fuel filler flap.



- ▶ Turn the engine off
 - by turning the SmartKey to position **0**. Remove the SmartKey from the starter switch.
 - by pressing the KEYLESS-GO* start/stop button. Open the driver's door (with driver's door open, starter switch is now in position **0**, same as with SmartKey removed from starter switch).
- ▶ Open the fuel filler flap by pushing at the point indicated by the arrow. The fuel filler flap springs open.
- ▶ Turn the fuel cap to the left and hold on to it until possible pressure is released.
- ▶ Take off the cap and set it in the recess on the fuel filler flap.

To prevent fuel vapors from escaping into open air, fully insert filler nozzle unit.
- ▶ Only fill your tank until the filler nozzle unit cuts out – do not top up or overfill.

Warning!



Overfilling of the fuel tank may create pressure in the system which could cause a gas discharge. This could cause the gas to spray back out when removing the fuel pump nozzle, which could cause personal injury.

- ▶ Replace the fuel cap by turning it to the right.
You will hear when the fuel cap is tightened.
- ▶ Close the fuel filler flap.



Only use premium unleaded gasoline with a minimum Posted Octane Rating of 91 (average of 96 RON / 86 MON). Information on gasoline quality can normally be found on the fuel pump.

More information on gasoline can be found in the Factory Approved Service Products pamphlet.



Leaving the engine running and the fuel cap open can cause the **CHECK ENGINE** lamp to illuminate.

More information can be found in the “Practical hints” section (▷ page 308).

Operation

At the gas station

Operation

At the gas station

Check regularly and before a long trip

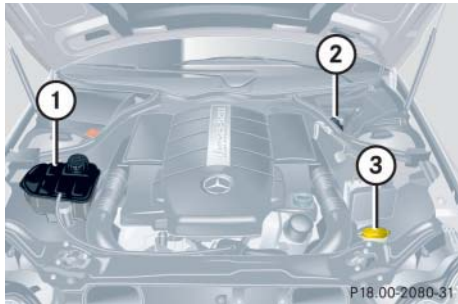

- ① Coolant level
More information on coolant can be found in the “Operation” section on (▷ page 286).
- ② Brake fluid (fuse box cover removed)
Removing fuse box cover (▷ page 373)
- ③ Windshield washer and headlamp cleaning system
More information on refilling the reservoir can be found in the “Operation” section on (▷ page 289).



If you find that the brake fluid in the brake fluid reservoir has fallen to the minimum mark or below, have the brake system checked for brake pad thickness and leaks immediately. Notify an authorized Mercedes-Benz Center immediately. Do not add brake fluid as this will not solve the problem. For more information, see also “Practical hints” (▷ page 307).

Engine oil level

More information on engine oil (▷ page 283).

Opening hood (▷ page 281).

Vehicle lighting

Check function and cleanliness. For more information on replacing light bulbs, see “Replacing bulbs” (▷ page 350).

Exterior lamp switch (▷ page 47)

Tire inflation pressure

More information on tire inflate pressure (▷ page 292).

▼ Engine compartment

Hood

Warning!



Do not pull the release lever while the vehicle is in motion. Otherwise the hood could be forced open by passing air flow.

Opening

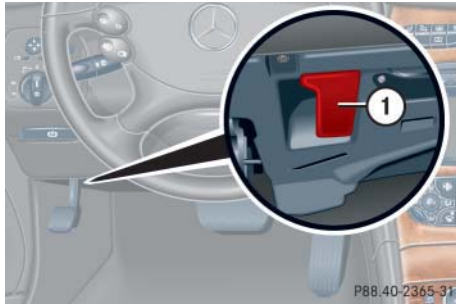

① Hood lock release

- ▶ Pull lever ① downwards.
The hood is unlocked.



To avoid damage to the windshield wipers or hood, never open the hood if the wiper arms are folded forward away from the windshield.



② Lever for opening the hood

Operation

Engine compartment

- ▶ Push lever ② under the hood upwards.
- ▶ Pull up on the hood and then release it.

The hood will be automatically held open at shoulder height by gas-filled struts.

Warning!



To help prevent personal injury, stay clear of moving parts when the hood is open and the engine is running. Make sure the hood is properly closed before driving. When closing the hood, use extreme caution not to catch hands or fingers.

The radiator fan may continue to run for approximately 30 seconds or may even restart after the engine has been turned off. Stay clear of fan blades.



Operation

Engine compartment



Warning!



If you see flames or smoke coming from the engine compartment, or if the coolant temperature gauge indicates that the engine is overheated, do not open the hood. Move away from the vehicle and do not open the hood until the engine has cooled. If necessary, call the fire department.

Warning!



The engine is equipped with a transistorized ignition system. Because of the high voltage it is dangerous to touch any components (ignition coils, spark plug sockets, diagnostic socket) of the ignition system

- with the engine running
- while starting the engine
- if ignition is “on” and the engine is turned manually

Closing

Warning!



Be careful that you do not close the hood on anyone.

- ▶ Let the hood drop from a height of approximately 1 ft (30 cm).

The hood will lock audibly.

- ▶ Make sure the hood is fully closed.

If you can raise the hood at a point above the headlamps, then it is not properly closed. Open it again and let it drop with somewhat greater force.

Engine oil

The amount of oil your engine needs will depend on a number of factors, including driving style. Higher oil consumption can occur when

- the vehicle is new
- the vehicle is driven frequently at higher engine speeds

Engine oil consumption checks should only be made after the vehicle break-in period.



Do not use any special lubricant additives, as these may damage the drive assemblies. Using special additives not approved by Mercedes-Benz will restrict your warranty entitlement.

More information on this subject is available at any Mercedes-Benz Center.

Checking engine oil level with the control system

When checking the oil level the vehicle must

- be parked on level ground
- be at normal operating temperature
- have been stationary for at least five minutes with the engine turned off

To check the engine oil level via the multifunction display, do the following:

- ▶ Turn the SmartKey in the starter switch to position **2** or press the KEYLESS GO* start/stop button twice.

The standard display (▷ page 129) should appear in the multifunction display.

- ▶ Press button or on the steering wheel until the following message is seen in the multifunction display:

Engine oil level
Measuring now!
Measurement
correct
only if veh. level



One of the following messages will subsequently appear in the indicator:

- Engine oil level ok
- Add 1.0 qt. to reach max. oil level!

(Canada: 1.0 liter)



▷▷

Operation

Engine compartment

- ▷▷ • Add 1.5 qt.
to reach max. oil level!
(Canada: 1.5 liter)
- Add 2.0 qt.
to reach max. oil level!
(Canada: 2.0 liter)



If you want to interrupt the checking procedure, press the  or  button on the multifunction steering wheel.

- ▶ If necessary, add engine oil.

For adding engine oil see (▷ page 285).

More information on engine oil can be found in the “Technical data” section (▷ page 388) and (▷ page 390).

Other display messages

If the SmartKey is not turned to position **2** in the starter switch, the following message will appear:

Turn on ignition
to see engine oil level!

- ▶ Switch on the ignition.

If you see the message:

Observe waiting time

- ▶ If engine is at normal operating temperature, wait five minutes before repeating check procedure.
- ▶ If engine is not yet at normal operating temperature, wait 30 minutes before repeating check procedure.

If you see the message:

Engine oil level
Not when engine on!

- ▶ Turn off the engine.
- ▶ If the engine is at normal operating temperature, wait five minutes before checking oil.
- ▶ If the engine is not yet at normal operating temperature, you must wait 30 minutes before checking oil.

If there is excess engine oil with the engine at normal operating temperature, the following message will appear:

Engine oil level
Reduce oil level!

- ▶ Have excess oil siphoned or drained off. Contact your authorized Mercedes-Benz Center.



Excess oil must be siphoned or drained off. It could cause damage to the engine and catalytic converter not covered by the Mercedes-Benz Limited Warranty.

More information on messages in the display concerning engine oil can be found in the “Practical hints” section (▷ page 326).

Adding engine oil



Only use approved engine oils. For a listing of approved engine oils, refer to the Factory Approved Service Products pamphlet in your vehicle literature portfolio.

In addition, check the oil filler cap for important information pertaining to the engine oil needing to meet a specific Mercedes-Benz specification (e.g. MB 229.5). If such information is printed on the oil filler cap, only use an engine oil from the list of approved engine oils in the Factory Approved Service Products pamphlet that meets the specification indicated on the oil filler cap. Using engine oils of other specification may cause the FSS to incorrectly determine the next service interval and will result in engine damage not covered by the Mercedes-Benz Limited Warranty.

Operation

Engine compartment



① Filler cap

- ▶ Unscrew filler cap ① from filler neck. Be careful not to overfill with oil.
- ▶ Add engine oil as required. Be careful not to overfill with oil.

Be careful not to spill any oil when adding. Avoid environmental damage caused by oil entering the ground or water. ▷▷

Operation

Engine compartment



Excess oil must be siphoned or drained off. It could cause damage to the engine and catalytic converter not covered by the Mercedes-Benz Limited Warranty.

- ▶ Screw filler cap ① back on filler neck.

More information on engine oil can be found in the “Technical data” section (▷ page 388) and (▷ page 390).

Transmission fluid level

The transmission fluid level does not need to be checked. If you notice transmission fluid loss or gear shifting malfunctions, have an authorized Mercedes-Benz Center check the automatic transmission.

Coolant

The engine coolant is a mixture of water and anticorrosion/antifreeze. To check the coolant level, the vehicle must be parked on level ground and the engine must be cool.

The coolant expansion tank is located on the passenger side of the engine compartment.

Warning!



In order to avoid any possibly serious burns:

- Use extreme caution when opening the hood if there are any signs of steam or coolant leaking from the cooling system, or if the coolant temperature gauge indicates that the coolant is overheated.
- Do not remove pressure cap on coolant reservoir if engine temperature is above 194°F (90°C). Allow engine to cool down before removing cap. The coolant reservoir contains hot fluid and is under pressure.
- Using a rag, slowly open the cap approximately ½ turn to relieve excess pressure. If opened immediately, scalding hot fluid and steam will be blown out under pressure.
- Do not spill antifreeze on hot engine parts. Antifreeze contains ethylene glycol which may burn if it comes into contact with hot engine parts.

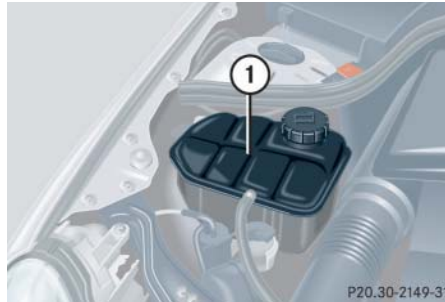

① Coolant expansion tank

- ▶ Using a rag, turn the cap slowly approximately one half turn to the left to release any excess pressure.
- ▶ Continue turning the cap to the left and remove it.

The coolant level is correct if the level

- for cold coolant: reaches the black top part of the reservoir
- for warm coolant: is approx. 0.6 in (1.5 cm) higher
- ▶ Add coolant as required.
- ▶ Replace and tighten cap.

More information on coolant can be found in the “Technical data” section (▷ page 392).

Operation

Engine compartment

Battery

Your vehicle's battery is located on the right side of the engine compartment.

The battery should always be sufficiently charged in order to achieve its rated service life. Refer to Service Booklet for battery maintenance intervals.

If you use your vehicle mostly for short-distance trips, you will need to have the battery charge checked more frequently.

When replacing the battery, always use batteries approved by Mercedes-Benz.

If you do not intend to operate your vehicle for an extended period of time, consult an authorized Mercedes-Benz Center about steps you need to observe.



Observe all safety instructions and precautions when handling automotive batteries.



Risk of explosion



Keep flames or sparks away from battery. Do not smoke.



Battery acid is caustic. Do not allow it to come into contact with skin, eyes or clothing.

In case it does, immediately flush affected area with clear water and seek medical help if necessary.



Wear eye protection.



Keep children away.



Follow the instructions in this Operator's Manual.

Batteries contain materials that can harm the environment if disposed of improperly. Recycling of batteries is the preferred method of disposal. Many states require sellers of batteries to accept old batteries for recycling.

Windshield washer system and headlamp cleaning system*

The windshield washer reservoir is located in the engine compartment.

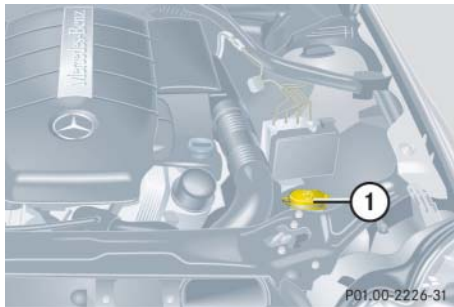

① Washer fluid reservoir

Fluid for the windshield washer system and the headlamp cleaning system is supplied from the windshield washer reservoir. It has a capacity of approx. 6.4 US qt (6 l).

During all seasons, add MB Windshield Washer Concentrate “S” to water. Pre-mix the windshield washer fluid in a suitable container.

- ▶ Refill the reservoir with MB Windshield Washer Concentrate “S” and water (or commercially available premixed windshield washer solvent / antifreeze, depending on ambient temperatures).

Always use washer solvent/antifreeze where temperatures may fall below the freezing point. Failure to do so could result in damage to the washer system/reservoir.



Only use washer fluid which is suitable for plastic lenses. Improper washer fluid can damage the plastic lenses of the headlamps.

Operation

Engine compartment



The windshield washer system on this vehicle is heated, so a fluid mixture produced to resist freezing at temperatures of approximately 14°F (-10°C) should be sufficient.

Warning!



Washer solvent/antifreeze is highly flammable. Do not spill washer solvent/antifreeze on hot engine parts, because it may ignite and burn. You could be seriously burned.

For more information, see “Windshield washer system and headlamp cleaning system*” (▷ page 394).

Operation

Tires and wheels

▼ Tires and wheels

See your authorized Mercedes-Benz Center for information on tested and recommended rims and tires for summer and winter operation. They can also offer advice concerning tire service and purchase.

Warning!



Replace rims or tires with the same designation, manufacturer and type as shown on the original part. See your authorized Mercedes-Benz Center for further information. If incorrectly sized rims and tires are mounted:

- The wheel brakes or suspension components can be damaged.
- The correct operating clearance of the wheels and tires is no longer guaranteed.

Warning!



Worn, old tires can cause accidents. If the tire tread is badly worn, or if the tires have sustained damage, replace them.

When replacing rims, only use genuine Mercedes-Benz wheel bolts specified for the particular rim type. Failure to do so can result in the bolts loosening and possibly an accident.

Retreaded tires are not tested or recommended by Mercedes-Benz, since previous damage cannot always be recognized on retreads. Mercedes-Benz can therefore not assure the operating safety of the vehicle when such tires are used.

Important guidelines

- Only use sets of tires and rims of the same type and make.
- Tires must be of the correct size for the rim.
- Break in new tires for approximately 60 miles (100 km) at moderate speeds.
- Regularly check the tires and rims for damage. Dented or bent rims can cause tire pressure loss and damage the tire beads.
- If vehicle is heavily loaded, check tire pressure and correct as required.
- Do not allow your tires to wear down too far. Adhesion properties on wet roads are sharply reduced at tread depths under $\frac{1}{8}$ in (3 mm).
- When replacing individual tires, you should mount new tires on the front wheels first (on vehicles with same-sized wheels all around).

Life of tires

The service life of a tire is dependent upon various factors including but not limited to:

- Driving style
- Tire pressure
- Distance driven

Warning!



Tires and spare tire should be replaced after six years, regardless of the remaining tread.



Keep unmounted tires in a cool, dry place with as little exposure to light as possible. Protect tires from contact with oil, grease and gasoline.

Direction of rotation

Unidirectional tires offer added advantages, such as better hydroplaning performance. To benefit, however, you must make sure the tires rotate in the direction specified.

An arrow on the sidewall indicates the intended direction of tire rotation.

Operation

Tires and wheels

Checking tire inflation pressure

Warning!



If the tire pressure drops repeatedly:

- Check the tires for punctures from foreign objects.
- Check to see whether air is leaking from the valves or from around the rim.

Correct the tire pressure only when tires are cold.

Regularly check your tire pressure at intervals of no more than 14 days.

If the tires are warm you should only correct the tire pressure if it is too low for current operating conditions.

A table on the fuel filler flap lists the specified tire inflation pressures for warm and cold tires as well as for various operating conditions.



The pressures listed for light loads are minimum values offering high driving comfort.

Increased inflation pressures listed for heavier loads may also be used for light loads. These higher pressures produce favorable handling characteristics. The ride of the vehicle, however, will be somewhat harder. Never exceed the max. values or inflate tires below the min. values listed in the fuel filler flap.

Tire pressure changes by approximately 1.5 psi (0.1 bar) per 18°F (10°C) of air temperature change. Keep this in mind when checking tire pressure where the temperature is different from the outside temperature.

Tire temperature and tire pressure are also increased while driving, depending on the driving speed and the tire load.

Warning!



Follow recommended inflation pressures.

Do not overinflate tires. Overinflating tires can result in sudden deflation (blowout) because they are more likely to become punctured or damaged by road debris, potholes, etc.

Do not underinflate tires. Underinflated tires wear unevenly, adversely affect handling and fuel economy, and are more likely to fail from being overheated.

Do not overload the tires by exceeding the specified vehicle capacity weight (as indicated by the label on the pillar in the driver's door opening). Overloading the tires can overheat them, possibly causing a blowout.

Check the spare tire periodically for condition and inflation. Spare tires will age and become worn over time even if never used, and thus should be inspected and replaced when necessary.

Rotating wheels

Warning!



Rotate front and rear wheels only if they are of the same size.

On vehicles with the same wheel size all around, wheels can be rotated every 3000 to 6000 miles (5000 to 10000 km), or sooner if necessary, according to the degree of tire wear. The same direction of tire rotation must be retained.

Rotate the wheels before the characteristic tire wear pattern becomes visible (shoulder wear on front wheels and tread center wear on rear wheels).

Thoroughly clean the inner side of the wheels after each rotation. Check and ensure proper tire inflation pressure.

Warning!



Have the tightening torque checked after changing a wheel. Wheels could become loose if not tightened with a torque of 80 lb-ft (110 Nm).

Only use genuine Mercedes-Benz wheel bolts specified for your vehicle's rims.

Operation

Winter driving

▼ Winter driving

Before the onset of winter, have your vehicle winterized at an authorized Mercedes-Benz Center. This service includes:

- Check of anticorrosion and antifreeze concentration.
- Addition of cleaning concentrate to the water of the windshield and headlamp cleaning system. Add MB Concentrate "S" to a premixed windshield washer solvent / antifreeze which is formulated for temperatures below freezing point (▷ page 394).
- Battery test. Battery capacity drops with decreasing ambient temperature. A well charged battery helps to ensure that the engine can be started even at low ambient temperatures.
- Tire change. Mercedes-Benz recommends M+S rated radial-ply tires with a minimum tread depth of approximately $\frac{1}{6}$ in (4 mm) on all four wheels for the winter season.

Winter tires

Always use winter tires at temperatures below 45°F (7°C) and whenever wintry road conditions prevail. Use of winter tires is the only way to achieve the maximum effectiveness of the ABS and the ESP in winter operation.

For safe handling, ensure that all mounted winter tires are of the same make and have the same tread design.

Warning!



Winter tires with a tread depth under $\frac{1}{6}$ in (4 mm) must be replaced. They are no longer suitable for winter operation.

Always observe the speed rating of the winter tires installed on your vehicle. If the maximum speed for which your tires are rated is below the speed rating of your vehicle, you must place a notice to this effect where it will be seen by the driver. Such notices are available at your tire dealer or any authorized Mercedes-Benz Center.

Warning!



If you use your spare tire when winter tires are fitted on the other wheels, be aware that the difference in tire characteristics may very well impair turning stability and that overall driving stability may be reduced. Adapt your driving style accordingly.

Have the spare tire replaced with a winter tire at the nearest authorized Mercedes-Benz Center.

Block heater*

(Canada only)

The engine is equipped with a block heater.

The electrical cable may be installed at your authorized Mercedes-Benz Center.

Snow chains

Snow chains should only be driven on snow-covered roads at speeds not to exceed 30 mph (50 km/h). Remove chains as soon as possible when driving on roads without snow.



When driving with snow chains, you may wish to deactivate the ESP (▷ page 79) before setting the vehicle in motion. This will improve the vehicle's traction.

Please observe the following guidelines when using snow chains:

- Using snow chains is not permissible with all wheel/tire combinations.
- Snow chains should only be used on the rear wheels. Follow the manufacturer's mounting instructions.

- Only use snow chains that are approved by Mercedes-Benz. Your authorized Mercedes-Benz Center will be glad to advise you on this subject.
- Use of snow chains may be prohibited depending on location. Always check local and state laws before installing snow chains.



Use of snow chains is not permissible with tire sizes:

- 225/50 R16 92H
- 245/40 R17 91W
- 245/40 R17 91Y
- T 125/80 R17 99M
- T 125/90 R 16 98M

Operation

Maintenance

▼ Maintenance

We strongly recommend that you have your vehicle serviced by your authorized Mercedes-Benz Center, in accordance with the Service Booklet at the times called for by the FSS (Flexible Service System).

Failure to have the vehicle maintained in accordance with the Service Booklet at the designated times/mileage called for by the FSS may result in vehicle damage not covered by the Mercedes-Benz Limited Warranty.



FSS will notify you when your next service is due.

Approximately one month before your next service is due, one of the following messages will appear in the multifunction display while you are driving or when you switch on the ignition (example service A):

Service A in XXXXX miles (km)
Service A in XXX days
Service A in X day
Service A due now!



The type of service due is indicated in the multifunction display:

-  Minor service (A)
-  Major service (B)



The interval between services depends on your driving habits. A gentle driving style, moderate engine speeds and the avoidance of short-distance trips will lengthen the interval between services.

Clearing the service indicator

The service indicator is automatically cleared after 30 seconds. You can also clear it yourself.

- ▶ Press the reset button on the instrument cluster (▷ page 126).

Service term exceeded





If you have exceeded the suggested service term, you will see the following message in the multifunction display:

Service A exceeded by XXXXX miles (km)
Service A exceeded by XXX days
Service A exceeded by X day

An acoustic signal will also sound.

The Mercedes-Benz Center will reset the service indicator following a completed service.

Calling up the service indicator

- ▶ Switch on ignition.
The standard display of the control system appears (▷ page 129).
- ▶ Press button  or  on the multifunction steering wheel until FSS indicator with the service symbol  or  and the service deadline appears in the multifunction display.







If the battery is disconnected, the days of disconnection will not be included in the count shown by the service indicator. To arrive at the true service deadline, you will need to subtract these days from the days shown in the service indicator.

Do not confuse the service indicator with the engine oil level indicator .

Resetting the service indicator

In the event that the service on your vehicle is not carried out by an authorized Mercedes-Benz Center, you can reset the service indicator yourself.

- ▶ Switch on ignition.
The standard display of the control system appears (▷ page 129).
- ▶ Press button  or  on the multifunction steering wheel until the FSS indicator with the service symbol  or  and the service deadline appears in the multifunction display.
- ▶ Press reset button to the left in the instrument cluster for about three seconds.

This message appears in the multifunction display:

Service interval...
To reset:
Press reset button
for 3 seconds

- ▶ To confirm, press reset button until you hear a signal.

The service indicator now displays the reset interval.



If the service indicator was inadvertently reset, have a Mercedes-Benz Center correct it.

Only reset if the proper service has been performed. Resetting the system without performing proper service as called for by the FSS will cause the FSS to incorrectly determine the next service interval which will result in engine damage not covered by the Mercedes-Benz Limited Warranty.

Operation

Vehicle care

▼ Vehicle care

Cleaning and care of vehicle

Warning!



Many cleaning products can be hazardous. Some are poisonous, others are flammable. Always follow the instructions on the particular container. Always open your vehicle's doors or windows when cleaning the inside. Never use fluids or solvents that are not designed for cleaning your vehicle.

While in operation, even while parked, your vehicle is subjected to varying external influences which, if gone unchecked, can attack the paintwork as well as the underbody and cause lasting damage.

Such damage is caused not only by extreme and varying climatic conditions, but also by:

- Air pollution
- Road salt
- Tar
- Gravel and stone chipping

To avoid paint damage, you should immediately remove:

- Grease and oil
- Fuel
- Coolant
- Brake fluid
- Bird droppings
- Insects
- Tree resins, etc.

Frequent washing reduces and /or eliminates the aggressiveness and potency of the above adverse influences.

More frequent washings are necessary to deal with unfavorable conditions:

- near the ocean
- in industrial areas (smoke, exhaust emissions)
- during winter operation

You should check your vehicle from time to time for stone chipping or other damage. Any damage should be repaired as soon as possible to prevent corrosion.

In doing so, do not neglect the underbody of the vehicle. A prerequisite for a thorough check is a washing of the underbody followed by a thorough inspection. Damaged areas need to be re-undercoated.

Your vehicle has been treated at the factory with a wax-base rustproofing in the body cavities which will last for the lifetime of the vehicle. Post-production treatment is neither necessary nor recommended by Mercedes-Benz because of the possibility of incompatibility between materials used in the production process and others applied later.

We have selected car-care products and compiled recommendations which are specially matched to our vehicles and which always reflect the latest technology. You can obtain Mercedes-Benz approved car-care products at your authorized Mercedes-Benz Center.

Scratches, corrosive deposits, corrosion or damage due to negligent or incorrect care cannot always be removed or repaired with the car-care products recommended here. In such cases it is best to seek aid at your authorized Mercedes-Benz Center.

The following topics deal with the cleaning and care of your vehicle and give important “how-to” information as well as references to Mercedes-Benz approved car-care products.

Additional information can be found in the booklet “Vehicle Care Guide”.

Power washer

When using a power washer for cleaning the vehicle, always observe the manufacturer’s operating instructions.



Vehicles with KEYLESS-GO*:

If a door handle is hit by a strong jet of water, and a SmartKey with KEYLESS-GO* is in close proximity, i.e. within approx. 3 ft (approx. 1 m), the vehicle could be inadvertently locked or unlocked.



Never use a round nozzle to power-wash tires. The intense jet of water can result in damage to the tire.

Always replace a damaged tire.

Always keep the jet of water moving across the surface. Do not aim directly at electrical parts, electrical connectors, seals, or other rubber parts.

Tar stains

Quickly remove tar stains before they dry and become more difficult to remove. A tar remover is recommended.

Paintwork, painted body components

Mercedes-Benz approved Paint Care should be applied when water drops on the paint surface do not “bead up”, normally every three to five months, depending on climate and washing detergent used.

Mercedes-Benz approved Paint Cleaner should be applied if the paint surface shows signs of embedded dirt (i.e. loss of gloss).

Do not apply any of these products or wax if your vehicle is parked in the sun or if the hood is still hot.

Use the appropriate MB-Touch-Up Stick for quick and provisional repairs of minor paint damage (i.e. chips from stones, vehicle doors, etc.).

Operation

Vehicle care

Engine cleaning

Prior to cleaning the engine compartment, make sure to protect electrical components and connectors from the intrusion of water and cleaning agents.

Corrosion protection, such as MB Anticorrosion Wax, should be applied to the engine compartment after every engine cleaning. Before applying, all control linkage bushings and joints should be lubricated. The poly-V-belt and all pulleys should be protected from any wax.

Vehicle washing

Do not use hot water or wash your vehicle in direct sunlight. Only use a mild car wash detergent, such as Mercedes-Benz approved Car Shampoo.

Thoroughly spray the vehicle with a diffused jet of water. Direct only a very weak spray towards the ventilation intake. Use plenty of water and rinse the sponge and chamois frequently.

Rinse with clear water and thoroughly dry with a chamois. Do not allow cleaning agents to dry on the finish.

Due to the width of the vehicle, fold in outside mirrors prior to running the vehicle through an automatic car wash to prevent damage to the mirrors.

In the winter, thoroughly remove all traces of road salt as soon as possible.

When washing the underbody, do not forget to clean the inner sides of the wheels.



Vehicles with KEYLESS-GO*:

If a door handle is hit by a strong jet of water, and a SmartKey with KEYLESS-GO* is in close proximity, i.e. within approx. 3 ft (approx. 1 m), the vehicle could be inadvertently locked or unlocked.

Ornamental moldings

For regular cleaning and care of very dirty chrome-plated parts, use a chrome cleaner.

Headlamps, tail lamps, side markers, turn signal lenses

Use a mild car wash detergent, such as Mercedes-Benz approved Car Shampoo, with plenty of water.

To prevent scratches, never apply strong force and only use a soft, non-scratchy cloth when cleaning the lenses. Do not attempt to wipe dirty lenses with a dry cloth or sponge.

Cleaning the Distronic* system sensor cover



- ① Distronic* system sensor cover
- ▶ Use a mild car wash detergent, such as Mercedes-Benz approved Car Shampoo, with plenty of water to clean sensor cover ①.

To prevent scratches, never apply strong force and only use a soft, non-scratchy cloth when cleaning the sensor cover. Do not attempt to wipe dirty sensors with a dry cloth or sponge.

Cleaning the Parktronic* system sensors

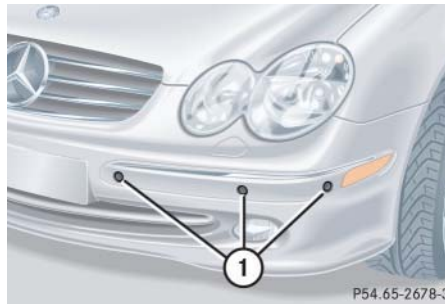

- ① Parktronic* system sensors
- ▶ Use a mild car wash detergent, such as Mercedes-Benz approved Car Shampoo, with plenty of water to clean sensors ①.

When using a steam cleaner or power washer, aim nozzle only briefly from a minimum distance of 4 in (10 cm) at sensors ①.

To prevent scratches, never apply strong force and only use a soft, non-scratchy cloth when cleaning the sensor. Do not attempt to wipe dirty sensors with a dry cloth or sponge.

Operation

Vehicle care

Wiper blades

- ▶ Fold wiper arm forward until it snaps into place.

Warning!



For safety reasons, switch off wipers and remove SmartKey from starter switch before cleaning the wiper blades. Otherwise the wiper motor might suddenly turn on and cause injury.

- ▶ Clean the wiper blade inserts with a clean cloth and detergent solution.



Fold the windshield wiper arms back onto the windshield before turning the SmartKey in the starter switch.

Hold on to the wiper when folding the wiper arm back. If released, the force of the impact from the tensioning spring could crack the windshield.

Window cleaning

- ▶ Fold wiper arm forward until it snaps into place.

Warning!



For safety reasons, switch off wipers and remove SmartKey from starter switch before cleaning the windshield. Otherwise the wiper motor might suddenly turn on and cause injury.

- ▶ Use a window cleaning solution on all glass surfaces.

An automotive glass cleaner is recommended.



Fold the windshield wiper arms back onto the windshield before turning the SmartKey in the starter switch.

Hold on to the wiper when folding the wiper arm back. If released, the force of the impact from the tensioning spring could crack the windshield.

Light alloy wheels

Mercedes-Benz approved Wheel Care should be used for regular cleaning of the light alloy wheels.

If possible, clean wheels once a week with Mercedes-Benz approved Wheel Care, using a soft bristle brush and a strong spray of water.

Follow instructions on container.



Only use acid-free cleaning materials. Acid may cause corrosion or damage the clear coat.

Instrument cluster

Use a gentle dishwashing detergent or mild detergent for delicate fabrics as a washing solution. Wipe with a cloth moistened in lukewarm solution. Do not use scouring agents.

Steering wheel and gear selector lever

Wipe with a damp cloth and dry thoroughly or clean with Mercedes-Benz approved Leather Care.

Cup holder

Use a gentle dishwashing detergent or mild detergent for delicate fabrics as a washing solution. Wipe with a cloth moistened in lukewarm solution. Do not use scouring agents.

Hard plastic trim items

Pour Mercedes-Benz approved Interior Care onto soft lint-free cloth and apply with light pressure.

Headliner and rear window shelf

Clean with soft bristle brush, or use a dry-shampoo cleaner in case of excessive dirt.

Seat belts

The webbing must not be treated with chemical cleaning agents. Only use clear, lukewarm water and soap. Do not dry the webbing at temperatures above 176°F (80°C) or in direct sunlight.

Warning!



Do not bleach or dye seat belts as this may severely weaken them. In a crash they may not be able to provide adequate protection.

Operation

Vehicle care

Upholstery

Using aftermarket seat covers or wearing clothing that have the tendency to give off coloring (e.g. when wet, etc.) may cause the upholstery to become permanently discolored. By lining the seats with a proper intermediate cover, contact-discoloration will be prevented.

Leather upholstery

Wipe leather upholstery with a damp cloth and dry thoroughly or clean with Mercedes-Benz approved Leather Care. Exercise particular care when cleaning perforated leather as its underside should not become wet.

Nubuck leather upholstery (CLK 55 AMG)

The nubuck leather upholstery is treated with a protective coating. Wipe nubuck leather upholstery with damp microfiber cloth to remove dust and other light stains. Carefully dab nubuck leather upholstery with a microfiber cloth to remove oil stains.



Do not use Mercedes-Benz approved Leather Care or any solvents to clean nubuck leather upholstery.

Avoid hard scrubbing on nubuck leather upholstery.

Plastic and rubber parts

Do not use oil or wax on these parts.

Wood trims

Dampen cloth using water and use damp cloth to clean wood trims in your vehicle. Do not use solvents like tar remover or wheel cleaner nor polishes or waxes as these may be abrasive.



Practical hints

What to do if ...?

Where will I find...?

Unlocking/locking in an emergency

Opening/closing in an emergency

Replacing bulbs

Replacing wiper blades

Flat tire

Battery

Jump starting

Towing the vehicle

Fuses

Practical hints

What to do if ...?

▼ What to do if ...?

Lamps in instrument cluster

General information:

If a bulb in the instrument cluster fails to come on during the bulb self-check when

turning the SmartKey in the starter switch to position **2**, have it checked and replaced if necessary.

Problem	Possible cause	Suggested solution
 The yellow ABS malfunction indicator lamp comes on while driving.	<p>The ABS has detected a malfunction and has switched off. The BAS and the ESP are also switched off (see messages in display).</p> <p>The brake system is still functioning normally but without the ABS available.</p>	<ul style="list-style-type: none"> ▶ Continue driving with added caution. Wheels will lock during hard braking, reducing steering capability. ▶ Have the system checked at an authorized Mercedes-Benz Center as soon as possible. <p>Failure to follow these instructions increases the risk of an accident.</p> <ul style="list-style-type: none"> ▶ Read and observe messages in the display (▷ page 314).
	<p>The charging voltage has fallen below 10 volts. The ABS has switched off.</p>	<p>When the voltage is above this value again, the ABS is operational again.</p> <ul style="list-style-type: none"> ▶ If necessary, have the generator (alternator) and battery checked.

Practical hints

What to do if ...?

Problem	Possible cause	Suggested solution
BRAKE (USA only)  (Canada only) The red brake warning lamp comes on while driving and you hear a warning sound.	You are driving with the parking brake set.	► Release the parking brake (▷ page 46).
The red brake warning lamp comes on while driving.	There is insufficient brake fluid in the reservoir.	► Risk of accident! Carefully stop the vehicle and notify an authorized Mercedes-Benz Center. Do not add brake fluid! This will not solve the problem.

Warning!



Driving with the brake warning lamp illuminated can result in an accident. Have your brake system checked immediately if the brake warning lamp stays on. Do not add brake fluid before checking the brake system.

Overfilling the brake fluid reservoir can result in spilling brake fluid on hot engine parts and the brake fluid catching fire. You can be seriously burned.



If you find that the brake fluid in the brake fluid reservoir has fallen to the minimum mark or below, have the brake system checked for brake pad thickness and leaks.



Practical hints

What to do if ...?

Problem	Possible cause	Suggested solution
CHECK ENGINE The yellow "CHECK ENGINE" malfunction indicator lamp comes on while driving.	There is a malfunction in: <ul style="list-style-type: none"> • The fuel management system • The ignition system • The emission control system • Systems which impact emissions Such malfunctions may result in excessive emissions values and may switch the engine to its Limp-Home Mode (emergency operation).	► Have the vehicle checked as soon as possible by an authorized Mercedes-Benz Center. An on-board diagnostic connector is used by the service station to link the vehicle to the shop diagnostics system. It allows the accurate identification of system malfunctions through the read-out of diagnostic trouble codes. It is located in the front left area of the footwell next to the parking brake pedal.
	The fuel cap is not closed tightly.	► Check the fuel cap.
	Your gas tank is empty.	► After refuelling, start the engine three or four times in succession. The Limp-Home mode is canceled. You do not need to have your vehicle checked.

Practical hints

What to do if ...?

Problem	Possible cause	Suggested solution
 <p>The red coolant warning lamp comes on when the engine is running.</p>	There is insufficient coolant in the reservoir.	▶ Add coolant to prevent engine from overheating (▷ page 286).
	If this warning lamp comes on frequently, there is a leak in the cooling system.	▶ Have the cooling system checked.
	If the coolant level is correct, the electric radiator fan may be broken.	▶ If the coolant temperature is below 257 °F (125 °C), you can continue driving to the nearest authorized Mercedes-Benz Center. ▶ Avoid high engine loads (e.g. driving uphill) and stop-and-go driving.
 <p>The red coolant warning lamp comes on while driving and you hear a warning sound.</p>	The coolant temperature has exceeded 257 °F (125 °C).	▶ Stop as soon as possible and allow the engine and coolant to cool down.

Warning!





Driving when your engine is badly overheated can cause some fluids which may have leaked into the engine compartment to catch fire. You could be seriously burned.

Steam from an overheated engine can cause serious burns and can occur just by opening the hood. Stay away from the engine if you see or hear steam coming from it.

Turn off the engine, get out of the vehicle and do not stand near the vehicle until the engine has cooled down.



Practical hints

What to do if ...?

Problem	Possible cause	Suggested solution
 The red Distance warning lamp comes on while driving.	You are too close to the vehicle in front of you to maintain selected speed.	▶ Apply the brakes immediately to increase the following distance.
 The red Distance warning lamp comes on while driving and you hear a warning sound.	<ul style="list-style-type: none">• You are gaining too rapidly on the vehicle ahead of you.• The distance warning system has recognized a stationary obstacle on your probable line of travel.	<ul style="list-style-type: none">▶ Apply the brakes immediately.▶ Carefully observe the traffic situation. You may need to brake or maneuver to avoid hitting an obstacle.
 The yellow ESP warning lamp comes on while driving.	<p>The ESP is deactivated.</p> <p>Risk of accident!</p> <p>Adapt your speed and driving to the prevailing road and weather conditions.</p>	<ul style="list-style-type: none">▶ Switch the ESP back on (▷ page 80). <p>If the ESP cannot be switched back on, have the system checked at an authorized Mercedes-Benz Center as soon as possible.</p>

Practical hints

What to do if ...?

Problem	Possible cause	Suggested solution
 The yellow ESP warning lamp flashes while driving.	The ESP or traction control has come into operation because of detected traction loss in at least one tire. Distronic* is deactivated.	<ul style="list-style-type: none">▶ When driving off, apply as little throttle as possible.▶ While driving, ease up on the accelerator.▶ Adapt your speed and driving to the prevailing road and weather conditions.▶ Do not deactivate the ESP. Exceptions: (▷ page 79). Failure to follow these instructions increases the risk of an accident.
 The yellow fuel tank reserve warning lamp comes on while driving.	The fuel level has gone below the reserve mark.	<ul style="list-style-type: none">▶ Refuel at the next gas station (▷ page 278).
 The red seat belt non-usage warning lamp illuminates briefly after starting the engine.	The warning lamp reminds you to fasten seat belts.	<ul style="list-style-type: none">▶ Fasten your seat belt.

Practical hints

What to do if ...?

Problem	Possible cause	Suggested solution
SRS The red SRS indicator lamp comes on while driving.	There is a malfunction in the restraint systems. The airbags or emergency tensioning device (ETD) could deploy unexpectedly or fail to activate in an accident.	► Drive with added caution to the nearest authorized Mercedes-Benz Center.

Warning!



In the event that a malfunction of the SRS is indicated as outlined above, the SRS may not be operational. For your safety, we strongly recommend that you visit an authorized Mercedes-Benz Center immediately to have the system checked; otherwise the SRS may not be activated when needed in an accident, which could result in serious or fatal injury, or it might deploy unexpectedly and unnecessarily, which could result in an accident and/or injury to you or to others.

Lamp in center console

Problem	Possible cause	Suggested solution
<p>PASS. AIRBAG OFF The indicator lamp comes on.</p>	<p>A BabySmart^{TM1} child seat is installed on the front passenger seat. Therefore the passenger front airbag is switched off.</p> <p>The system is malfunctioning when there is no BabySmartTM child seat installed on the front passenger seat.</p>	<p>▶ Have the system checked as soon as possible by an authorized Mercedes-Benz Center.</p>
<p>PASS. AIRBAG OFF The indicator lamp does not come on with a BabySmartTM child seat properly installed on the front passenger seat.</p>	<p>The system is malfunctioning.</p>	<p>▶ Make sure there is nothing between seat cushion and child seat and check installation of the child seat.</p> <p>▶ If the light remains out, have the system checked as soon as possible by an authorized Mercedes-Benz Center.</p> <p>Do not use the BabySmartTM restraint to transport children on the front passenger seat until the system has been repaired.</p>

¹ BabySmartTM is a trademark of Siemens Automotive Corp.

Practical hints

What to do if ...?

Messages in the display

The control system shows warning and malfunction messages in the multifunction display.

Certain warning and malfunction messages are accompanied by an audible signal.

Address these messages accordingly and follow the additional instructions given in this Operator's Manual.

Selecting the malfunction memory menu in the control system (▷ page 138) displays both cleared and uncleared messages.

High-priority messages appear in the multifunction display in red color.

Certain messages of high priority cannot be cleared from the multifunction display using the reset button (▷ page 126).

Other high priority messages and messages of less immediate priority (regular display colors) can be cleared from the multifunction display using the reset button and are then stored in the malfunction message memory (▷ page 138).

Warning!



All categories of messages contain important information which should be taken note of and, where a malfunction is indicated, addressed as soon as possible at an authorized Mercedes-Benz Center.

Failure to repair the condition noted may cause damage not covered by the Mercedes-Benz Limited Warranty, or result in property damage or personal injury.

Warning!



No messages will be displayed if either the instrument cluster or the multifunction display is inoperative.

Contact your nearest authorized Mercedes-Benz Center.



Turning the SmartKey in starter switch to position **2**, or pressing the KEYLESS-GO* start/stop button twice to position **2** causes all lamps as well as the multifunction display to come on. Ensure that they are all in working order before starting your journey.

On the pages that follow, you will find a compilation of the most important warning and malfunction messages that may appear in the display. High priority messages appear on a red background.

Text messages

Display	Display message	Possible cause	Possible solution
ABS	Anti-lock braking system not working!	<p>The charging voltage has fallen below 10 volts and the ABS has switched off.</p> <p>The brake system is still functioning normally but without the ABS available.</p>	<ul style="list-style-type: none"> ▶ When the voltage is above this value again, the ABS is operational again. ▶ Continue driving with added caution. Wheels will lock during hard braking, reducing steering capability. ▶ Have the system checked at an authorized Mercedes-Benz Center as soon as possible. <p>Failure to follow these instructions increases the risk of an accident.</p>
	Defective! Visit workshop!	<p>The ABS has detected a malfunction and has switched off. The ESP and the BAS are also deactivated.</p> <p>The brake system is still functioning normally but without the ABS available.</p>	<ul style="list-style-type: none"> ▶ Continue driving with added caution. Wheels will lock during hard braking, reducing steering capability. ▶ Have the system checked at an authorized Mercedes-Benz Center as soon as possible. <p>Failure to follow these instructions increases the risk of an accident.</p>

Practical hints

What to do if ...?

Display	Display message	Possible cause	Possible solution
ABS	Display defective! Visit workshop!	The ABS or the ABS display is malfunctioning.	<ul style="list-style-type: none"> ▶ Continue driving with added caution. Wheels will lock during hard braking, reducing steering capability. ▶ Have the system checked at an authorized Mercedes-Benz Center as soon as possible. <p>Failure to follow these instructions increases the risk of an accident.</p>
BAS	Defective! Visit workshop	The BAS has detected a malfunction and switched off.	<ul style="list-style-type: none"> ▶ Continue driving with added caution. ▶ Have the system checked at an authorized Mercedes-Benz Center as soon as possible. <p>Failure to follow these instructions increases the risk of an accident.</p>
	Display defective Visit workshop	BAS or the BAS display is malfunctioning.	<ul style="list-style-type: none"> ▶ Continue driving with added caution. ▶ Have the system checked at an authorized Mercedes-Benz Center as soon as possible. <p>Failure to follow these instructions increases the risk of an accident.</p>

Practical hints

What to do if ...?

Display	Display message	Possible cause	Possible solution
BAS	not available See operator's manual	The charging voltage has fallen below 10 volts and the BAS has switched off. The brake system is still functioning normally but without the BAS available.	<ul style="list-style-type: none"> ▶ When the voltage is above this value again, the BAS is operational again. ▶ Have the system checked at an authorized Mercedes-Benz Center as soon as possible. <p>Failure to follow these instructions increases the risk of an accident.</p>
Cruise Control	Visit workshop!	Cruise control or Distronic* is malfunctioning.	<ul style="list-style-type: none"> ▶ Have cruise control or Distronic* checked by an authorized Mercedes-Benz Center.
Distronic	External interference Reactivate!	Distronic* is switched off and is temporarily unavailable.	<ul style="list-style-type: none"> ▶ Try activating Distronic* again later.
	Currently unavailable! see oper. manual	Distronic* is switched off because the Distronic* cover in the radiator grille is dirty.	<ul style="list-style-type: none"> ▶ Clean the Distronic* cover in the radiator grille (▷ page 301). ▶ Restart the vehicle.
	Visit workshop!	Distronic* is malfunctioning or the display is malfunctioning.	<ul style="list-style-type: none"> ▶ Visit an authorized Mercedes-Benz Center as soon as possible.

Practical hints

What to do if ...?

Display	Display message	Possible cause	Possible solution
ESP	Defective! Visit workshop!	The ESP was deactivated because of a malfunction or interrupted power supply. The ABS might not be operational.	<ul style="list-style-type: none"> ▶ Continue driving with added caution. ▶ Visit an authorized Mercedes-Benz Center as soon as possible. <p>Failure to follow these instructions increases the risk of an accident.</p>
	Display defective Visit workshop!	The ESP or the ESP display is malfunctioning.	<ul style="list-style-type: none"> ▶ Continue driving with added caution. ▶ Visit an authorized Mercedes-Benz Center as soon as possible. <p>Failure to follow these instructions increases the risk of an accident.</p>
	not available! See operator's manual	The charging voltage has fallen below 10 volts and the ESP has switched off.	<p>When the voltage is above this value again, the ESP is operational again.</p> <ul style="list-style-type: none"> ▶ If necessary, have the generator (alternator) and battery checked.
		The self-diagnosis has not been completed.	The display will clear after driving a short distance at more than 12 mph (20 km/h).

Practical hints

What to do if ...?

Display	Display message	Possible cause	Possible solution
P	Selector lever in park position	You have turned off the engine with the KEYLESS-GO* start/stop button in gear selector lever position N and opened the driver's door. or You have attempted to switch off the engine with the KEYLESS-GO* start/stop button while the gear selector lever was in position R or D .	► Place the gear selector lever in position P .
	Please move selector lever to P or N	You have attempted to start the engine with the KEYLESS-GO* start/stop button while the gear selector lever was in position R or D .	► Place the gear selector lever in position P or N .

Practical hints





What to do if ...?

Symbol messages

Display symbol	Display message	Possible cause	Possible solution
	Undervoltage Charge battery	The battery has insufficient voltage.	▶ Start the engine (▷ page 43).
	Undervoltage Switch off consumers	The battery has insufficient voltage.	▶ Turn off unnecessary electrical consumers.
	VISIT WORKSHOP!	<p>The battery was charged with a battery charger or jump started.</p> <p>The battery is no longer charging. Possible causes:</p> <ul style="list-style-type: none"> • alternator malfunctioning • broken poly-V-belt <p>Do not forget that the brake system requires electrical energy and may be operating with restricted capability. Considerably greater brake pedal force is required and the stopping distance is increased.</p>	<p>▶ Have the battery checked at a service station.</p> <p>▶ Stop immediately and check the poly-V-belt.</p> <p>If it is broken:</p> <p>▶ Do not continue to drive. Otherwise the engine will overheat due to an inoperative water pump which may result in damage to the engine. Notify an authorized Mercedes-Benz Center.</p> <p>If it is intact:</p> <p>▶ Drive immediately to the nearest authorized Mercedes-Benz Center. Adjust driving to be consistent with reduced braking responsiveness.</p>

Practical hints

What to do if ...?

Display symbol	Display message	Possible cause	Possible solution
	Brake wear Visit workshop	The brake pads have reached their wear limit.	► Have the brake pads replaced as soon as possible.
 (USA only)  (Canada only)	Parking brake release brake!	You are driving with the parking brake set.	► Release the parking brake (▷ page 46).
 (USA only)  (Canada only)	Brake fluid Visit workshop	There is insufficient brake fluid in the reservoir.	► Risk of accident! Stop the vehicle and notify an authorized Mercedes-Benz Center. Do not add brake fluid! This will not solve the problem.

Warning!



Driving with this message displayed can result in an accident. Have your brake system checked immediately. Do not add brake fluid before checking the brake system. Overfilling the brake fluid reservoir can result in spilling brake fluid on hot engine parts and the brake fluid catching fire. You can be seriously burned.





If you find that the brake fluid in the brake fluid reservoir has fallen to the minimum mark or below, have the brake system checked for brake pad thickness and leaks.



Brake pad thickness must be visually checked by a qualified technician at the intervals specified in the Service Booklet.

Practical hints

What to do if ...?

Display symbol	Display message	Possible cause	Possible solution
	Visit workshop!	There may be a malfunction in the <ul style="list-style-type: none">• fuel injection system• ignition system• exhaust system• fuel system	<ul style="list-style-type: none">▶ Have the measuring system checked by an authorized Mercedes-Benz Center.
	Coolant Check level	The coolant level is too low.	<ul style="list-style-type: none">▶ Add coolant (▷ page 286).▶ If you have to add coolant frequently, have the cooling system checked by an authorized Mercedes-Benz Center.

Warning!



Do not spill antifreeze on hot engine parts. Antifreeze contains ethylene glycol which may burn if it comes into contact with hot engine parts. You can be seriously burned.



Do not ignore the low engine coolant level warning. Extended driving with the message and symbol displayed may cause serious engine damage not covered by the Mercedes-Benz Limited Warranty.

Do not drive without sufficient amount of coolant in the cooling system. The engine will overheat, causing major engine damage.

Practical hints

What to do if ...?

Display symbol	Display message	Possible cause	Possible solution
	Coolant Stop, engine off!	The coolant is too hot.	<ul style="list-style-type: none">▶ Stop the vehicle and turn off the engine.▶ Only start the engine again after the message disappears. You could otherwise damage the engine.

Warning!



Driving when your engine is badly overheated can cause some fluids which may have leaked into the engine compartment to catch fire. You could be seriously burned.

Steam from an overheated engine can cause serious burns and can occur just by opening the hood. Stay away from the engine if you see or hear steam coming from it.

Turn off the engine, get out of the vehicle and do not stand near the vehicle until the engine has cooled down.

During severe operating conditions and stop-and-go city traffic, the coolant temperature may rise close to 248°F (120°C).



The engine should not be operated with the coolant temperature above 248°F (120°C). Doing so may cause serious engine damage which is not covered by the Mercedes-Benz Limited Warranty.



Practical hints

What to do if ...?

Display symbol	Display message	Possible cause	Possible solution
	Coolant Stop, engine off!	The poly-V-belt could be broken.	<ul style="list-style-type: none"> ▶ Stop immediately and check the poly-V-belt. <p>If it is broken:</p> <ul style="list-style-type: none"> ▶ Do not continue to drive. Otherwise the engine will overheat due to an inoperative water pump which may result in damage to the engine. Notify an authorized Mercedes-Benz Center. <p>If it is intact:</p> <ul style="list-style-type: none"> ▶ Do not continue to drive the vehicle with this message displayed. Doing so could result in serious engine damage that is not covered by the Mercedes-Benz Limited Warranty.
	Coolant Visit workshop	The cooling fan for the coolant is malfunctioning.	<ul style="list-style-type: none"> ▶ Observe the coolant temperature display. ▶ Have the fan replaced as soon as possible.

Practical hints

What to do if ...?

Display symbol	Display message	Possible cause	Possible solution
	Display defective Visit workshop!	The instrument cluster display is malfunctioning.	▶ Continue driving with added caution. ▶ Visit an authorized Mercedes-Benz Center as soon as possible.
		The displays for several systems have malfunctioned. Some systems themselves may also have malfunctioned.	▶ Have the electronic systems checked by an authorized Mercedes-Benz Center.
	Display defective Visit workshop!	Certain electronic systems are unable to relay information to the control system. The following systems may have failed: <ul style="list-style-type: none">• Coolant temperature display• Tachometer• Cruise control display	▶ Have the electronic systems checked by an authorized Mercedes-Benz Center.
	Doors open!	You are attempting to drive with one or more doors open.	▶ Close the doors.

Practical hints

What to do if ...?

Display symbol	Display message	Possible cause	Possible solution
	<p>USA only: Add 1 qt. engine oil when next refueling</p> <p>Canada only: Add 1 liter engine oil when next refueling</p>	The engine oil level is too low.	<ul style="list-style-type: none"> ▶ Add engine oil (▷ page 285) and check the engine oil level (▷ page 283).
	<p>Engine oil level Reduce oil level!</p>	<p>You have added too much engine oil. There is a risk of damaging the engine or the catalytic converter.</p>	<ul style="list-style-type: none"> ▶ Have oil siphoned or drained off. Observe all legal requirements with respect to its disposal.
	<p>Engine oil level Stop, engine off!</p>	<p>There is no oil in the engine. There is a danger of engine damage.</p>	<ul style="list-style-type: none"> ▶ Carefully bring the vehicle to a halt as soon as possible. ▶ Turn off the engine. ▶ Add engine oil (▷ page 285) and check the engine oil level (▷ page 283).

Practical hints

What to do if ...?

Display symbol	Display message	Possible cause	Possible solution
	Engine oil Visit workshop!	It may be that there is water in the engine oil.	▶ Have the engine oil checked.
	Engine oil level Visit workshop!	The engine oil has dropped to a critical level.	▶ Check the engine oil level (▷ page 283) and add oil as required (▷ page 285). ▶ If you must add engine oil frequently, have the engine checked for possible leaks.
		The measuring system is malfunctioning.	▶ Have the measuring system checked by an authorized Mercedes-Benz Center.

When the message Add 1 qt. engine oil when next refueling (Canada: 1 liter) appears while the engine is running and at operating temperature, the engine oil level has dropped to approximately the minimum level.

When this occurs, the warning will first come on intermittently and then stay on if the oil level drops further.



Visually check for oil leaks. If no obvious oil leaks are noted, drive to the nearest service station where the engine oil should be topped to the required level with an approved oil.



The engine oil level warnings should not be ignored. Extended driving with the symbol displayed could result in serious engine damage that is not covered by the Mercedes-Benz Limited Warranty.



Practical hints

What to do if ...?

Display symbol	Display message	Possible cause	Possible solution
	Reserve fuel	The fuel level has dropped below the reserve mark.	▶ Refuel at the next gas station (▷ page 278).
	Hood open!	You are driving with the hood open.	▶ Close the hood (▷ page 282).
	Remove key	You have forgotten to remove the SmartKey.	▶ Remove the SmartKey from the starter switch.
	Replace key!	No additional code available for SmartKey or SmartKey with KEYLESS-GO*	▶ Visit an authorized Mercedes-Benz Center as soon as possible.
	Key Check battery!	The SmartKey with KEYLESS-GO* batteries are discharged.	▶ Change the batteries (▷ page 345).
	Key not recognized!	The SmartKey with KEYLESS-GO* is not recognized while the engine is running because <ul style="list-style-type: none"> • the SmartKey is not in the vehicle • there is strong radio-frequency interference 	▶ Stop the vehicle as soon as it is safe to do so. ▶ Search for the SmartKey. Otherwise the vehicle cannot be centrally locked nor can the engine be started again after the engine has been stopped.
		The SmartKey with KEYLESS-GO* is momentarily not recognized.	▶ Change the position of the SmartKey in the vehicle. ▶ Operate the vehicle with the SmartKey in the starter switch if necessary.

Practical hints

What to do if ...?

Display symbol	Display message	Possible cause	Possible solution
	Key recognized in vehicle	A SmartKey with KEYLESS-GO* left in the vehicle was recognized while locking the vehicle from the outside.	▶ Take the SmartKey out of the vehicle.
	Keyless Go Check system	The KEYLESS-GO* system is malfunctioning.	▶ Visit an authorized Mercedes-Benz Center as soon as possible.
	Key do not forget key	This display appears (for a maximum of 60 seconds) if the driver's door is opened with the engine shut off and no SmartKey in the starter switch. Message is only a reminder.	▶ Insert SmartKey in the starter switch. ▶ Take the SmartKey with KEYLESS-GO* with you when leaving the vehicle.
	3rd stop lamp	The high mounted brake lamp is malfunctioning.	▶ Visit an authorized Mercedes-Benz Center as soon as possible.
	Back- up lamp, left	The left backup lamp is malfunctioning.	▶ Replace the bulb as soon as possible.
	Back- up lamp, right	The right backup lamp is malfunctioning.	▶ Replace the bulb as soon as possible.
	Display defective! Visit workshop!	The display for the lamps or the system is malfunctioning.	▶ Visit an authorized Mercedes-Benz Center as soon as possible.
	Front foglamp, left	The left front fog lamp is malfunctioning.	▶ Replace the bulb as soon as possible.
	Front foglamp, right	The right front fog lamp is malfunctioning.	▶ Replace the bulb as soon as possible.

Practical hints

What to do if ...?

Display symbol	Display message	Possible cause	Possible solution
	High beam, left	The left high beam lamp is malfunctioning.	▶ Replace the bulb as soon as possible.
	High beam, right	The right high beam lamp is malfunctioning.	▶ Replace the bulb as soon as possible.
	Lamp sensor Visit workshop!	The lamp sensor is malfunctioning. The headlamps switch on automatically.	<ul style="list-style-type: none"> ▶ In the control system, set lamp operation to manual (▷ page 145). ▶ Switch on headlamps using the exterior lamp switch. ▶ Visit an authorized Mercedes-Benz Center as soon as possible.
	License plate lamp, left	The left license plate lamp is malfunctioning.	▶ Replace the bulb as soon as possible.
	License plate lamp, right	The right license plate lamp is malfunctioning.	▶ Replace the bulb as soon as possible.
	Low beam, left	The left low beam lamp is malfunctioning.	▶ Visit an authorized Mercedes-Benz Center as soon as possible.
	Low beam, right	The right low beam lamp is malfunctioning.	▶ Visit an authorized Mercedes-Benz Center as soon as possible.

Practical hints

What to do if ...?

Display symbol	Display message	Possible cause	Possible solution
	Parking lamp, front left Substitute lamp on	The left parking lamps are malfunctioning. A backup bulb is being used.	▶ Visit an authorized Mercedes-Benz Center as soon as possible.
	Parking lamp, front right Substitute lamp on	The right parking lamps are malfunctioning. A backup bulb is being used.	▶ Visit an authorized Mercedes-Benz Center as soon as possible.
	Side marker lamp, front left	The front left side marker lamp is malfunctioning.	▶ Replace the bulb as soon as possible.
	Side marker lamp front right	The front right side marker lamp is malfunctioning.	▶ Replace the bulb as soon as possible.
	Stop lamp, left	The left brake lamp is malfunctioning.	▶ Visit an authorized Mercedes-Benz Center as soon as possible.
	Stop lamp, right	The right brake lamp is malfunctioning.	▶ Visit an authorized Mercedes-Benz Center as soon as possible.
	Stop lamp Visit workshop!	Stop lamp illumination is delayed or lamp is permanently on.	▶ Visit an authorized Mercedes-Benz Center as soon as possible.
	Tail lamp, left Substitute lamp on!	The left tail lamp is malfunctioning. A backup bulb is being used.	▶ Visit an authorized Mercedes-Benz Center as soon as possible.
	Tail lamp, right Substitute lamp on!	The right tail lamp is malfunctioning. A backup bulb is being used.	▶ Visit an authorized Mercedes-Benz Center as soon as possible.

Practical hints

What to do if ...?

Display symbol	Display message	Possible cause	Possible solution
	Turn off lamps!	Lamps have been turned on although the SmartKey in the starter switch is in position 0 .	▶ Turn off the headlamps.
	Turn signal front left Substitute lamp on!	The left front turn signal lamp is malfunctioning. A backup bulb is being used.	▶ Replace the bulb as soon as possible.
	Turn signal front right Substitute lamp on!	The right front turn signal lamp is malfunctioning. A backup bulb is being used.	▶ Replace the bulb as soon as possible.
	Turn signal in left mirror	The left turn signal in the side mirror is malfunctioning. This message will only appear if all light emitting diodes have stopped working.	▶ Have the LEDs replaced as soon as possible.
	Turn signal in right mirror	The right turn signal in the side mirror is malfunctioning. This message will only appear if all light emitting diodes have stopped working.	▶ Have the LEDs replaced as soon as possible.
	Turn signal rear left Substitute lamp on!	The left rear turn signal lamp is malfunctioning. A backup bulb is being used.	▶ Replace the bulb as soon as possible.
	Turn signal rear right Substitute lamp on!	The right rear turn signal lamp is malfunctioning. A backup bulb is being used.	▶ Replace the bulb as soon as possible.



Practical hints

What to do if ...?

Display symbol	Display message	Possible cause	Possible solution
	Driver's seat belt Fasten seat belt!	The display reminds you and your passengers to fasten seat belts.	► Fasten the seat belts.
	Front passenger seat belt Please fasten belt!	The display reminds you and your passengers to fasten seat belts.	► Fasten the seat belts.
	Seat belt system Visit workshop	The seat belt system is malfunctioning.	► Visit an authorized Mercedes-Benz Center as soon as possible.

Practical hints

What to do if ...?

Display symbol	Display message	Possible cause	Possible solution
	defective Visit workshop!	One or more main functions of the Tele Aid system are malfunctioning.	► Have the Tele Aid system checked by an authorized Mercedes-Benz Center.
	Tele Aid battery Visit workshop!	The emergency power battery for the Tele Aid system is malfunctioning. If the vehicle battery is also dead, Tele Aid will not be operational.	► Have the Tele Aid system checked by an authorized Mercedes-Benz Center.
	Restraint system defective Visit workshop!	The system is malfunctioning.	► Drive with added caution to the nearest authorized Mercedes-Benz Center.

Warning!



In the event a malfunction of the SRS is indicated as outlined above, the SRS may not be operational. For your safety, we strongly recommend that you visit an authorized Mercedes-Benz Center immediately to have the system checked; otherwise the

SRS may not be activated when needed in an accident, which could result in serious or fatal injury, or it might deploy unexpectedly and unnecessarily which could also result in injury.

Practical hints

What to do if ...?

Display symbol	Display message	Possible cause	Possible solution
	Steering oil Visit workshop!	The steering gear oil level is too low. There is a danger of steering gear damage.	► Have the system checked by an authorized Mercedes-Benz Center.

Warning!









If the level of steering gear oil in reservoir is too low, the steering power assistance could fail. Much greater effort will then be needed to turn the steering wheel.

Do not add steering oil without checking the steering system.

Do not drive the vehicle. Have the system checked at your authorized Mercedes-Benz Center as soon as possible.

Practical hints

What to do if ...?

Display symbol	Display message	Possible cause	Possible solution
	Close sunroof!	You have opened the driver's door with the SmartKey removed from the starter switch and the sliding/pop-up roof open.	▶ Close the sliding/pop-up roof (▷ page 214).
	Close sunroof!	You have opened the driver's door with the SmartKey removed from the starter switch and the sliding/pop-up roof open.	▶ Close the sliding/pop-up roof (▷ page 214).
	Function Not available	This display appears if button  or  on the multifunction steering wheel is pressed and the vehicle is not equipped with a telephone.	
	Close trunk lid!	This message will appear whenever the trunk lid is open.	▶ Close the trunk lid.
	Washer fluid Check level	The fluid level has dropped to about $\frac{1}{3}$ of total reservoir capacity.	▶ Add washer fluid (▷ page 289).

Practical hints

Where will I find...?

▼ Where will I find...?

First aid kit

The first aid kit is stored in left hand side of the trunk.



- ▶ Loosen Velcro fastener.
- ▶ Remove first aid kit.



Check expiration dates and contents for completeness at least once a year and replace missing/expired items.

Vehicle tool kit

The vehicle tool kit is stored in the compartment underneath the trunk floor.

The following is included:

- Towing eye bolt
- Alignment bolt
- Wheel wrench
- Vehicle jack
- Wheel bolts

Removing the vehicle tool kit



- ① Retaining screw
 - ② Storage well casing
- ▶ Lift trunk floor cover and engage trunk floor handle in upper edge of trunk. ▷▷

Practical hints

Where will I find...?



To prevent damage, always disengage trunk floor handle from upper edge of trunk and lower trunk floor before closing the trunk lid.

- ▶ Loosen retaining screw ① in the middle of storage well casing ②.
- ▶ Remove storage well casing ②.

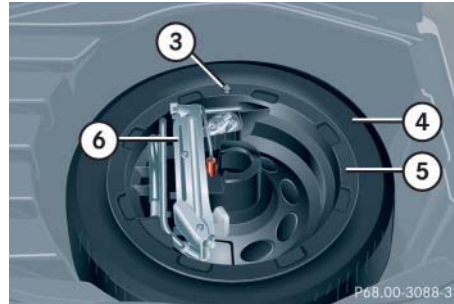

- ③ Arrow
- ④ Minispare wheel
- ⑤ Vehicle tool kit storage well casing
- ⑥ Vehicle tool kit
 - Wheel wrench
 - Vehicle jack
 - Wheel bolts for Minispare wheel

- ▶ Remove vehicle tool kit storage well casing ⑤.



Arrow ③ on vehicle tool kit storage well casing ⑤ must point in the direction of travel. Otherwise you cannot place the storage well casing 2 on top and secure the Minispare wheel with retaining screw ① (▷ page 337).

Vehicle jack

Warning!



The jack is designed exclusively for jacking up the vehicle at the jack take-up brackets built into both sides of the vehicle. To help avoid personal injury, use the jack only to lift the vehicle during a wheel change. Never get beneath the vehicle while it is supported by the jack. Keep hands and feet away from the area under the lifted vehicle. Always firmly set parking brake and block wheels before raising vehicle with jack.

Do not disengage parking brake while the vehicle is raised. Be certain that the jack is always vertical (plumb line) when in use, especially on hills. Always try to use the jack on a level surface. Make sure the jack arm is fully seated in the jack take-up bracket. Always lower the vehicle onto sufficient capacity jackstands before working under the vehicle.

The vehicle jack is stored in the space underneath the trunk floor together with the vehicle tool kit in the vehicle tool kit storage well casing.

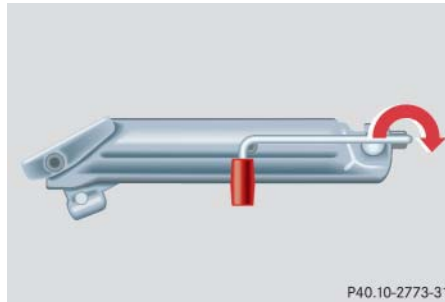

- ▶ Remove the vehicle jack from its compartment.
- ▶ Push the crank handle up.

Practical hints

Where will I find...?

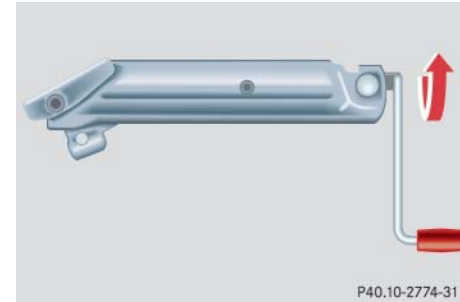

- ▶ Turn the crank handle clockwise until it engages (operational position).

Before storing the vehicle jack in its compartment:

- It should be fully collapsed
- The handle must be folded in (storage position)

Practical hints

Where will I find...?

Minispare wheel

The Minispare wheel is located in the compartment underneath the trunk floor.

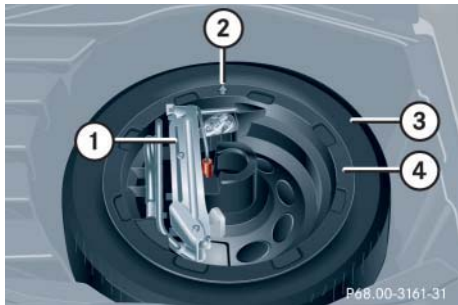

- ① Vehicle tool kit
 - Wheel wrench
 - Jack
 - Wheel bolts for Minispare wheel
- ② Arrow
- ③ Minispare wheel
- ④ Vehicle tool kit storage well casing

Removing the Minispare wheel

- ▶ Lift trunk floor cover and engage trunk floor handle in upper edge of trunk.
- ▶ Loosen the retaining screw (▷ page 337) in the middle of storage well casing.
- ▶ Remove storage well casing (▷ page 337).
- ▶ Remove vehicle tool kit storage well casing ④.
- ▶ Remove Minispare wheel ③.

Storing the Minispare wheel

- ▶ Place Minispare wheel ③ in wheel well.
- ▶ Place vehicle tool kit storage well casing ④ over the Minispare wheel. Make sure the arrow ② on storage well casing ④ points in the direction of travel.
- ▶ Place storage well casing (▷ page 337) over the vehicle tool kit storage well casing ④ and turn the retaining screw (▷ page 337) clockwise as far as it will go to secure the Minispare wheel.



The arrow ② on vehicle tool kit storage well casing ④ must point in the direction of travel, otherwise you cannot place the storage well casing (▷ page 337) on top and secure the Minispare wheel with the retaining screw (▷ page 337).



To prevent damage, always disengage trunk floor handle from upper edge of trunk and lower trunk floor before closing the trunk lid.

Warning!



The dimensions of the Minispare wheel are different from those of the road wheels. As a result, the vehicle handling characteristics change when driving with a Minispare wheel mounted.

The Minispare wheel should only be used temporarily, and should be replaced with a regular road wheel as quickly as possible.

Practical hints

Where will I find...?

In the case of a flat tire, you may temporarily use the Minispare wheel when observing the following restrictions:

- Do not exceed a vehicle speed of 50 mph (80 km/h).
- Drive to the nearest tire repair facility to have the flat tire repaired or replaced as appropriate.
- Do not operate vehicle with more than one Minispare wheel mounted.

More information can be found in the “Technical data” section (▷ page 381).

Practical hints

Where will I find...?

Minispare wheel bolts

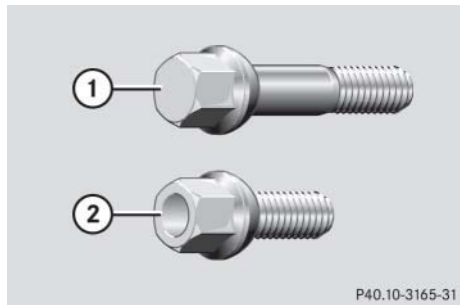

- ① Wheel bolt for light alloy rims
- ② Wheel bolt for Minispare wheel or other steel rims (located in trunk with spare wheel)



Wheel bolts ② must be used when mounting the Minispare wheel. The use of any wheel bolts other than wheel bolts ② for the Minispare will physically damage the vehicle's brakes.

Warning!



Be sure to use the original length wheel bolts when remounting the original wheel after it has been repaired.

▼ **Unlocking/locking in an emergency**

Unlocking the vehicle

If you are unable to unlock the vehicle with the SmartKey or KEYLESS-GO*, open the driver's door and the trunk using the mechanical key.



Unlocking your vehicle with the mechanical key will trigger the anti-theft alarm system. To cancel the alarm, do one of the following:

- Press button or on the SmartKey.
- Insert the SmartKey in the starter switch.

Vehicles with KEYLESS-GO*

- Pull the outside door handle.
- Press the KEYLESS-GO* start/stop button (▷ page 33).



P80.20-2390-31

- ① Mechanical key locking tab
- ② Mechanical key
- ▶ Move locking tab ① in direction of arrow and slide the mechanical key ② out of the housing.

Unlocking the driver's door

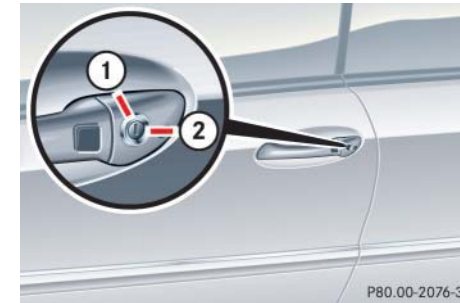

P80.00-2076-31

- ① Unlocking
- ② Locking
- ▶ Unlock the door with the mechanical key. To do so, push the mechanical key in the lock until it stops and turn it to the left.

Practical hints

Unlocking/locking in an emergency

Unlocking the trunk

A minimum height clearance of 5.41 ft (1.65 m) is required to open the trunk lid.

The lock is located next to the recessed handle.

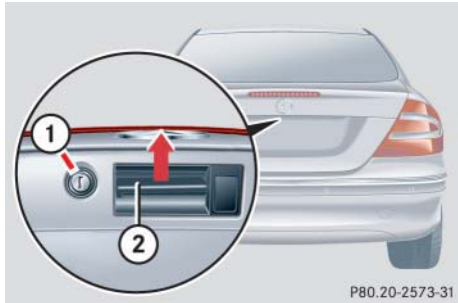

① Unlocking in an emergency

② Handle

- ▶ Insert the mechanical key into the trunk lid lock.
- ▶ Turn the mechanical key counterclockwise to position ① and hold it in this position.
- ▶ Pull the trunk lid handle ② and lift the trunk lid.



Always make sure there is sufficient overhead clearance.

Locking the vehicle

If you are unable to lock the vehicle with the SmartKey, lock it with the mechanical key as follows:

- ▶ Close the passenger door and the trunk lid.
- ▶ Press the central locking switch in the cockpit (▷ page 106).
- ▶ Check to see whether the locking knob on the passenger door is down. If necessary push it down manually.
- ▶ Lock the driver's door with the mechanical key.
- ▶ Lock the trunk lid if necessary with the mechanical key (▷ page 104).

Practical hints

Unlocking/locking in an emergency

Changing batteries in the SmartKey/ SmartKey with KEYLESS-GO*

If the batteries in the SmartKey or the SmartKey with KEYLESS-GO* are discharged, the vehicle can no longer be locked or unlocked. It is recommended to have the batteries replaced at an authorized Mercedes-Benz Center.

Warning!



Keep the batteries out of reach of children.

If a battery is swallowed, seek medical help immediately.

Batteries contain materials that can harm the environment if disposed of improperly. Recycling of batteries is the preferred method of disposal. Many states require sellers of batteries to accept old batteries for recycling.

SmartKey



When changing batteries, always replace both batteries.

The required replacement batteries are available at any Mercedes-Benz Center.

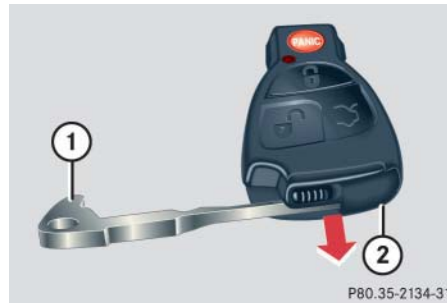

- ① Mechanical key
- ② Battery compartment

Replacement batteries: Lithium, type CR 2025 or equivalent.

- ▶ Remove mechanical key ① (▷ page 343).
- ▶ Insert the mechanical key in side opening and push gray slide.
The battery compartment is unlatched.
- ▶ Pull the battery compartment out of the SmartKey housing in direction of arrow.
- ▶ Remove the batteries. ▷▷

Practical hints

Unlocking/locking in an emergency

▷▷

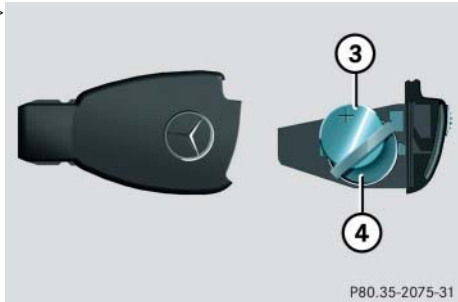

- ③ Battery
- ④ Contact spring

- ▶ Using a lint-free cloth, insert new batteries under the contact spring with the plus (+) side facing up.
- ▶ Return battery compartment into housing until it locks into place.

SmartKey with KEYLESS-GO*



When changing batteries, always replace both batteries.

The required replacement batteries are available at any Mercedes-Benz Center.

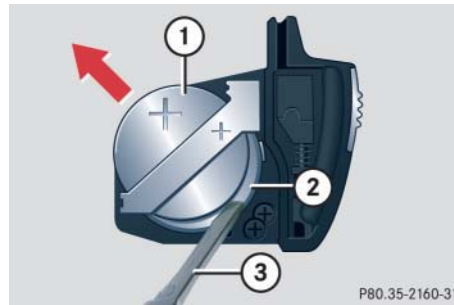

- 1 Battery
- 2 Tilt battery up
- 3 Mechanical key

Replacement batteries: Lithium, type CR 2025 or equivalent.

- ▶ Remove mechanical key (▷ page 343).
- ▶ Insert the mechanical key in side opening and push grey slide.
The battery compartment is unlatched.
- ▶ Pull the battery compartment out of the SmartKey housing in direction of arrow.
- ▶ Using mechanical key ③ apply pressure to position ②.
Battery ① tilts up slightly.
- ▶ Pull out batteries ① in direction of arrow.
- ▶ Using a lint-free cloth, insert new batteries with the plus (+) side facing up.
- ▶ Return battery compartment into housing until it locks into place.

Practical hints

Unlocking/locking in an emergency

Fuel filler flap

In case the central locking system does not release the fuel filler flap, you can open it manually.

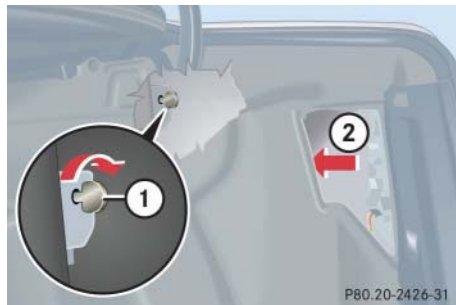

- ▶ Open trunk lid.
- ▶ Remove right side trim panel in the trunk.
- ▶ Reach inside through opening ② in direction of arrow.
- ▶ Turn release knob ① clockwise (arrow).
The fuel filler flap can be opened.

Manually unlocking the gear selector lever

In case of power failure, the gear selector lever can be manually unlocked, e.g. to tow the vehicle.

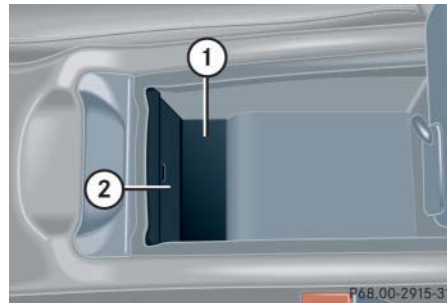

- ▶ Open the storage compartment under the center armrest (▷ page 246).
- ▶ Take out cover ①.
- ▶ Insert a pin into the opening of division ② and pry the division out.

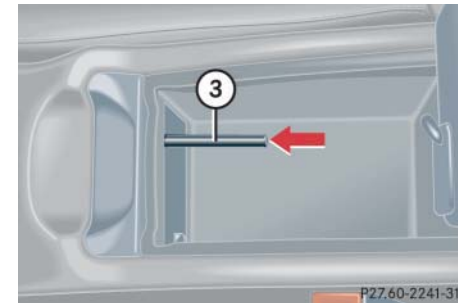

- ▶ Insert a tool ③ (e.g. screwdriver) into the opening.
- ▶ Perform the following two steps simultaneously:
 - ▶ Push pin ③ forward in the direction of the arrow.
 - ▶ Move gear selector lever from position **P**.
- ▶ Reinstall the division and cover after removing the tool from the opening.



The gear selector lever is locked again when moving it to position **P**.

Practical hints

Opening/closing in an emergency

▼ Opening/closing in an emergency

Sliding/pop-up roof*

You can open or close the sliding/pop-up roof manually should an electrical malfunction occur.

The sliding/pop-up roof drive is located behind the lens of the interior overhead light.



- ▶ Pry off lens ① using a flat blade screwdriver.



- ▶ Slide both locking tabs ② in direction of arrow.
- ▶ Lower rear of cover and remove.
- ▶ Remove cover.



Do not disconnect electrical connectors.

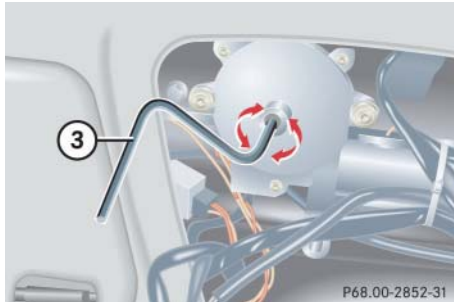

- ▶ Obtain crank ③.
- ▶ Insert crank ③ through hole.
- ▶ Turn crank ③ clockwise to:
 - slide roof closed
 - raise roof at the rear
- ▶ Turn crank ③ counterclockwise to:
 - slide roof open
 - lower roof at the rear

The sliding/pop-up must be resynchronized after being operated manually (▷ page 349).

Synchronizing the sliding/pop-up roof

- ▶ Take the fuse for the sliding/pop-up roof out of the main fuse box (▷ page 372).
- ▶ Reinsert the fuse.
- ▶ Switch on the ignition.
- ▶ Press the switch in the “raise” direction until the sliding/pop-up roof is fully raised at the rear.
Hold the switch for approximately one second.
The sliding/pop-up roof is adjusted.

Practical hints

Replacing bulbs

▼ Replacing bulbs

Safe vehicle operation depends on proper exterior lighting and signaling. It is therefore essential that all bulbs and lamp assemblies are in good working order at all times.

Correct headlamp adjustment is extremely important. Have headlamps checked and readjusted at regular intervals and when a bulb has been replaced. See your authorized Mercedes-Benz Center for headlamp adjustment.



If the headlamps are fogged up on the inside as a result of high humidity, driving the vehicle a distance should clear up the fogging.



Backup bulbs will be brought into use when the following lamps malfunction:

- Turn signal lamps
- Brake lamps
- Parking lamps
- Tail lamps

Bulbs



P54.00-2373-31

Practical hints

Replacing bulbs

Front lamps

	Lamp	Type
①	Halogen headlamps: Low beam	H7 (55 W)
	Bi-Xenon* headlamps: Low and high beam ¹	D2S-35 W
②	Halogen headlamps: High beam/high beam flasher	H7 (55 W)
	Bi-Xenon* headlamps: High beam flasher	H7 (55 W)
	Parking and standing lamps	W 5 W
③	Additional turn signal lamps	LED
④	Turn signal lamp	1 156 NA
⑤	Side marker lamp	W 5 W
⑥	Fog lamp	HB4/9006 (55 W)

¹ Vehicles with Bi-Xenon headlamps* do not replace the Bi-Xenon bulbs yourself.

Rear lamps

	Lamp	Type
⑦	Rear fog lamp, driver's side	P 21/4 W
	Turn signal lamp	P 21 W
	Brake lamp	P 21 W
	Backup lamp	P 21 W
⑧	Tail, parking and stand- ing lamp, side marker	P 21/4 W W 5 W
	⑧ High mounted brake lamp	LED
⑨	License plate lamps	C 5 W

Notes on bulb replacement

Warning!



Keep bulbs out of reach of children.

Bulbs and bulb sockets can be very hot. Allow the lamp to cool down before changing a bulb.

Halogen lamps contain pressurized gas. A bulb can explode if you:

- touch or move it when hot
- drop the bulb
- scratch the bulb

Wear eye and hand protection.

Because of high voltage in xenon lamps, it is dangerous to replace the bulb or repair the lamp and its components. We recommend that you have such work done by a qualified technician.

Practical hints

Replacing bulbs

- Only use 12 volt bulbs of the same type and with the specified watt rating.
- Switch lights off before changing a bulb to prevent short circuits.
- Always use a clean lint-free cloth when handling bulbs.
- Your hands should be dry and free of oil and grease.
- If the newly installed bulb does not come on, visit an authorized Mercedes-Benz Center.
- Have the LEDs and bulbs for the following lamps replaced by an authorized Mercedes-Benz Center.
 - Additional turn signal lamps in the exterior rear view mirrors
 - High mounted brake lamp
 - Bi-Xenon* lamps
 - Front fog lamps

Replacing bulbs for front lamps

Front lamps halogen-type

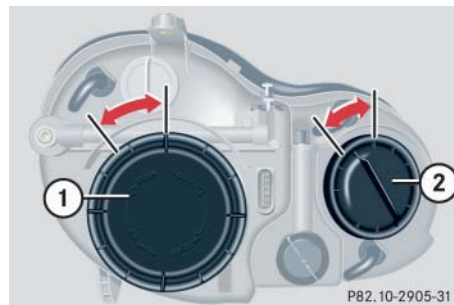

- ① Housing cover for low beam lamp
- ② Housing cover for high beam lamp

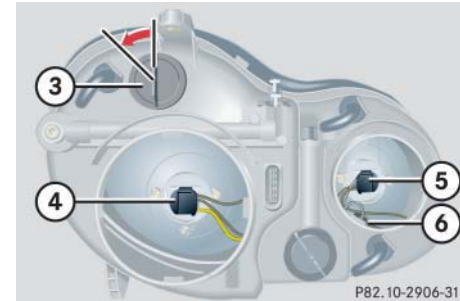

- ③ Bulb socket for turn signal lamp
- ④ Low beam bulb
- ⑤ High beam bulb
- ⑥ Parking and standing lamp

Practical hints

Replacing bulbs

Low beam and high beam bulb

- ▶ Switch off the lights.
- ▶ Open the hood (▷ page 281).
- ▶ Turn housing cover ① or ② counterclockwise and remove.
- ▶ Turn bulb holder ④ or ⑤ with the bulb counterclockwise and remove.
- ▶ Press the bulb backwards and turn counterclockwise out of the bulb holder.
- ▶ Press the new bulb into the holder and twist it clockwise.
- ▶ Place the bulb holder back into the lamp and turn it clockwise.
- ▶ Place the corresponding housing covers back on and turn them clockwise.

Front turn signal lamp bulb

- ▶ Switch off the lights.
- ▶ Open the hood (▷ page 281).
- ▶ Twist bulb socket ③ counterclockwise and pull out.
- ▶ Push bulb into socket, turn counterclockwise and remove.
- ▶ Insert new bulb in socket, push in and twist clockwise.
- ▶ Reinsert bulb socket in lamp and twist clockwise.

Parking and standing lamp bulb

- ▶ Switch off the lights.
- ▶ Open the hood (▷ page 281).
- ▶ Turn housing cover ② counterclockwise and remove.
- ▶ Pull out the bulb socket with the bulb.
- ▶ Pull the bulb out of the bulb socket.
- ▶ Insert a new bulb in the socket.
- ▶ Reinstall the bulb socket.
- ▶ Align housing cover and click into place.

Practical hints

Replacing bulbs

Front lamps Bi-Xenon*-type

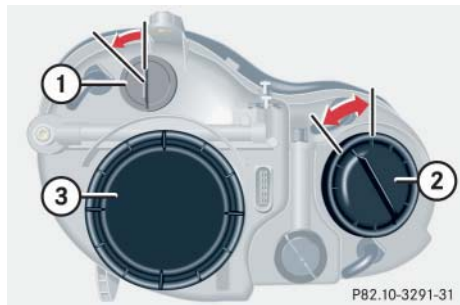

- ① Bulb socket for turn signal lamp
- ② Housing cover for high beam flasher lamp
- ③ Housing cover for Bi-Xenon* lamp

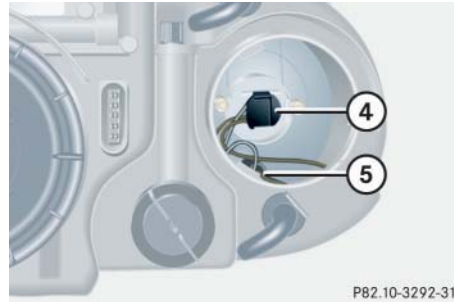

- ④ High beam flasher bulb
- ⑤ Parking and standing lamp

Warning!



Do not remove the cover ③ for the Bi-Xenon* headlamp. Because of high voltage in xenon lamps, it is dangerous to replace the bulb or repair the lamp and its components. We recommend that you have such work done by a qualified technician.

High beam bulb for high beam flasher

- ▶ Switch off the lights.
- ▶ Open the hood (▷ page 281).
- ▶ Turn housing cover ② counterclockwise and remove.
- ▶ Turn bulb holder ④ with the bulb counterclockwise and remove.
- ▶ Press the bulb backwards and turn counterclockwise out of the bulb holder.
- ▶ Press the new bulb into the holder and twist it clockwise.
- ▶ Place the bulb holder back into the lamp and turn it clockwise.
- ▶ Place the housing cover ② back on and turn them clockwise.

Practical hints

Replacing bulbs

Front turn signal lamp bulb

- ▶ Switch off the lights.
- ▶ Open the hood (▷ page 281).
- ▶ Twist bulb socket ① counterclockwise and pull out.
- ▶ Push bulb into socket, turn counterclockwise and remove.
- ▶ Insert new bulb in socket, push in and twist clockwise.
- ▶ Reinsert bulb socket in lamp and twist clockwise.

Parking and standing lamp bulb

- ▶ Switch off the lights.
- ▶ Open the hood (▷ page 281).
- ▶ Turn housing cover ② counterclockwise and remove.
- ▶ Pull out the bulb socket with the bulb.
- ▶ Pull the bulb out of the bulb socket.
- ▶ Insert a new bulb in the socket.
- ▶ Reinstall the bulb socket.
- ▶ Align housing cover and click into place.

Side marker lamp bulb

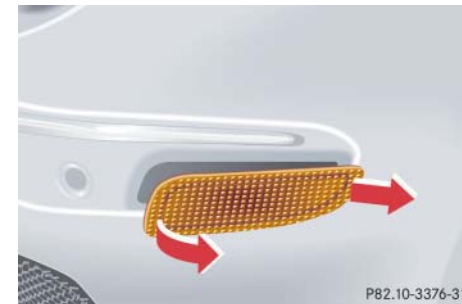

- ▶ Switch off the lights.
- ▶ Carefully slide lamp towards rear.
- ▶ Remove front end first.
- ▶ Twist bulb socket counterclockwise and pull out.
- ▶ Pull bulb out of the bulb socket.
- ▶ Insert new bulb in socket.
- ▶ Reinstall bulb socket, push in and twist clockwise.
- ▶ To reinstall lamp, set rear end in bumper and let front end snap into place.

Practical hints

Replacing bulbs

Replacing bulbs for rear lamps

Tail lamp assemblies

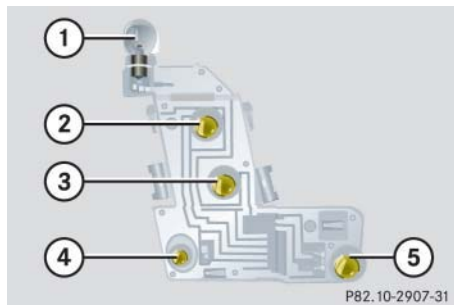

- ① Brake lamp
- ② Turn signal lamp
- ③ Backup lamp
- ④ Standing and side marker lamp
- ⑤ Rear fog lamp (driver's side)/tail

- ▶ Switch off the lights.
- ▶ Open trunk.
- ▶ Swing the trim panel covering the corresponding rear lights to the side.
- ▶ Squeeze tabs together and remove the bulb holder with the bulb.

- ▶ Twist bulb counterclockwise and pull out of bulb holder.
- ▶ Insert new bulb into the holder and turn it clockwise.
- ▶ Reinstall bulb holder. The tabs must audibly click.
- ▶ Close trim panel.
- ▶ Place the housing cover back on so that its tabs click in place.

License plate lamp

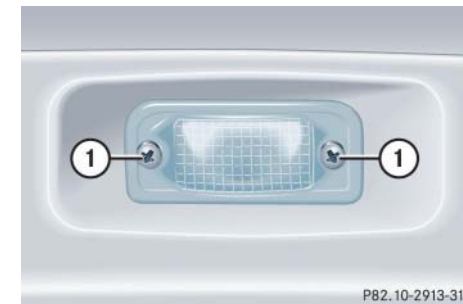

- ① Screws

- ▶ Switch off the lights.
- ▶ Loosen both screws ① and remove lamp.
- ▶ Replace the tubular lamp and reinstall lamp.
- ▶ Retighten the screws.

▼ Replacing wiper blades

Removing wiper blades

Warning!



For safety reasons, remove SmartKey from starter switch before replacing a wiper blade. Otherwise the motor could suddenly turn on and cause injury.

- ▶ Fold the wiper arm forward.

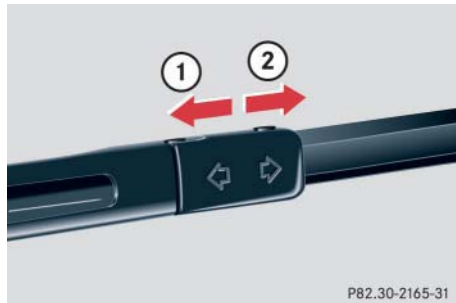

- ① Lock
- ② Unlock

- ▶ Pull the tab in direction of arrow ② and remove windshield wiper.

Installing wiper blades

- ▶ Slide the wiper blade into the cutout on the wiper arm.
- ▶ Slide the tab back in the direction of arrow ① until it audibly engages.
- ▶ Fold the wiper arm backward to rest on the windshield. Make sure you hold on to the wiper when folding the wiper arm back.

Practical hints

Replacing wiper blades



Never open the hood when the wiper arms are folded forward.

Hold on to the wiper when folding the wiper arm back. If released, the force of the impact from the tensioning spring could crack the windshield.

Do not allow the wiper arms to contact the windshield glass without a wiper blade inserted.

Make certain that the wiper blades are properly installed. Improperly installed wiper blades may cause windshield damage.

For your convenience, we recommend that you have this work carried out by an authorized Mercedes-Benz Center.

Practical hints

Flat tire

▼ Flat tire

Preparing the vehicle

- ▶ Park the vehicle as far as possible from moving traffic on a hard surface.
- ▶ Turn on the hazard warning flashers.
- ▶ Engage the steering wheel lock in the straight ahead position and set the parking brake.
- ▶ Move the gear selector lever to **P**.
- ▶ Have any passenger exit the vehicle at a safe distance from the roadway.

Mounting the Minispare wheel

Warning!



The dimensions of the Minispare wheel are different from those of the road wheels. As a result, the vehicle handling characteristics change when driving with a Minispare wheel mounted.

The spare wheel should only be used temporarily, and should be replaced with a regular road wheel as quickly as possible.

In case of a flat tire, you may temporarily use the spare wheel when observing the following restrictions:

- Do not exceed a vehicle speed of 50 mph (80 km/h).
- Drive to the nearest tire repair facility to have the flat tire repaired or replaced as appropriate.
- Do not operate the vehicle with more than one spare wheel mounted.

Prepare the vehicle as described on (▷ page 358).

- ▶ Take the wheel wrench and the jack out of the trunk (▷ page 337).
- ▶ Take the Minispare wheel and wheel bolts out of the trunk (▷ page 337).

Lifting the vehicle

- ▶ Prevent the vehicle from rolling away by blocking wheels with wheel chocks (not included) or other sizable objects.

When changing wheel on a level surface:

- ▶ Place one chock in front of and one behind the wheel that is diagonally opposite to the wheel being changed.

When changing wheel on a hill:

- ▶ Place chocks on the downhill side blocking both wheels of the other axle.

Warning!



The jack is designed exclusively for jacking up the vehicle at the jack take-up brackets built into both sides of the vehicle. To help avoid personal injury, use the jack only to lift the vehicle during a wheel change. Never get beneath the vehicle while it is supported by the jack. Keep hands and feet away from the area under the lifted vehicle. Always firmly set parking brake and block wheels before raising vehicle with jack.

Do not disengage parking brake while the vehicle is raised. Be certain that the jack is always vertical (plumb line) when in use, especially on hills. Always try to use the jack on a level surface. Make sure the jack arm is fully seated in the jack take-up bracket. Always lower the vehicle onto sufficient capacity jackstands before working under the vehicle.

Practical hints

Flat tire

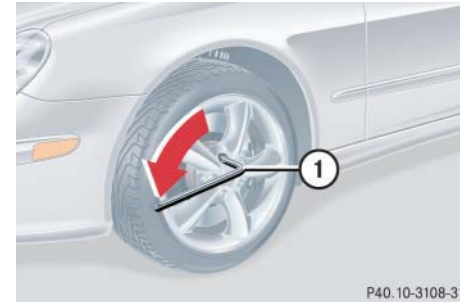

① Wheel wrench

- ▶ On wheel to be changed, loosen but do not yet remove the wheel bolts (approximately one full turn with wrench).

The jack take-up brackets are located directly behind the front wheel housings and in front of the rear wheel housings.

Practical hints

Flat tire

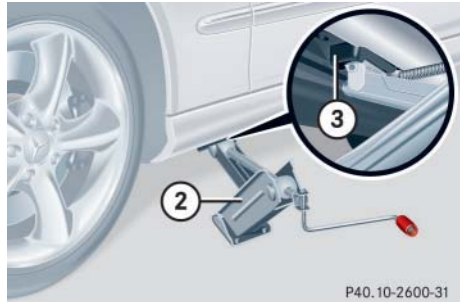

- ② Jack
- ③ Take-up bracket

- ▶ Place jack ② on firm ground.
- ▶ Position jack ② under take-up bracket ③ so that it is always vertical (plumb-line) as seen from the side, even if the vehicle is parked on an incline.

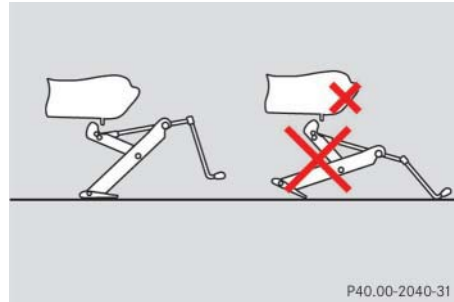

- ▶ Jack up the vehicle until the wheel is a maximum of 1.2 in (3 cm) from the ground. Never start engine while vehicle is raised.

Warning!



The jack is intended only for lifting the vehicle briefly for wheel changes. It is not suited for performing maintenance work under the vehicle.

- Never start the engine when the vehicle is raised.
- Never lie down under the raised vehicle.

Removing the wheel



- ① Alignment bolt

- ▶ Unscrew upper-most wheel bolt and remove.
- ▶ Replace this wheel bolt with alignment bolt ① supplied in the tool kit.
- ▶ Remove the remaining bolts.



Do not place wheel bolts in sand or dirt. This could result in damage to the bolt and wheel hub threads.

- ▶ Remove the wheel.

Mounting the new wheel

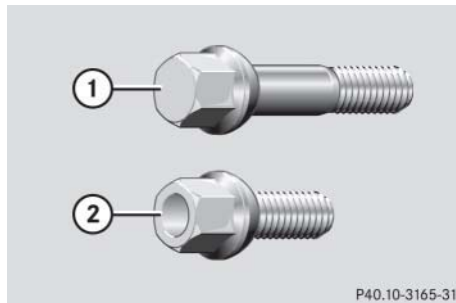

- ① Wheel bolt for light alloy rims
- ② Wheel bolt for Minispare wheel or other steel rims (located in trunk with spare wheel)



Wheel bolts ② must be used when mounting the Minispare wheel. The use of any wheel bolts other than wheel bolts ② for the Minispare will physically damage the vehicle's brakes.

- ▶ Clean contact surfaces of wheel and wheel hub.



To avoid paint damage, place wheel flat against hub and hold it there while installing first wheel bolt.

Warning!



Always replace wheel bolts that are damaged or rusted.

Never apply oil or grease to wheel bolts.

Damaged wheel hub threads should be repaired immediately. Do not continue to drive under these circumstances! Contact an authorized Mercedes-Benz Center or call Roadside Assistance.

Incorrect wheel bolts or improperly tightened wheel bolts can cause the wheel to come off. This could cause an accident. Make sure to use the correct wheel bolts.

Practical hints

Flat tire

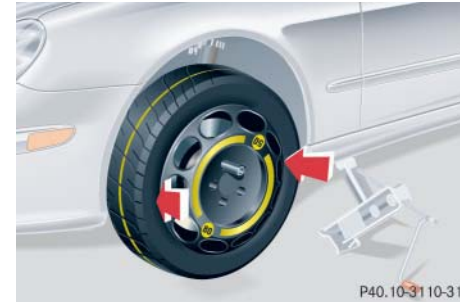

- ▶ Guide the spare wheel onto the alignment bolt and push it on.
- ▶ Insert wheel bolts and tighten them slightly. ▷▷

Practical hints

Flat tire

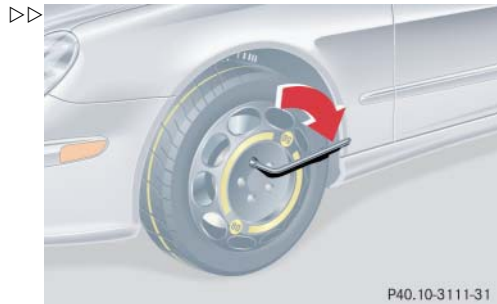

- ▶ Unscrew the alignment bolt, install last wheel bolt and tighten slightly.

Warning!



Only use genuine equipment Mercedes-Benz wheel bolts. Other wheel bolts may come loose.

Do not tighten the wheel bolts when the vehicle is raised. Otherwise the vehicle could tip over.

Lowering the vehicle

- ▶ Lower vehicle by turning crank counterclockwise until the full weight of the vehicle is resting on the ground.
- ▶ Remove the jack.

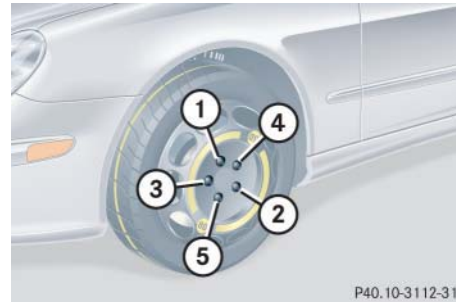

① - ⑤ Wheel bolts

- ▶ Tighten the five wheel bolts evenly, following the diagonal sequence illustrated (① to ⑤), until all bolts are tight. Observe a tightening torque of 80 lb-ft (110 Nm).

Warning!



Have the tightening torque checked after changing a wheel. The wheels could come loose if they are not tightened to a torque of 80 lb-ft (110 Nm).

- ▶ Before storing the jack in the trunk, it should be fully collapsed, with handle folded in.

▼ Battery

The battery is located on the right side of the engine compartment.

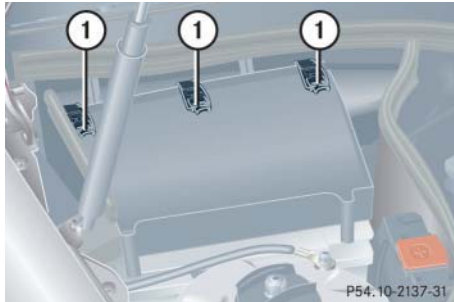

Removal of filter box:

- ▶ Release the three clamps ①.
- ▶ Remove filter box.

Installation of filter box:

- ▶ Insert filter box properly.
- ▶ Secure it with the three clamps ①.

Warning!



Failure to follow these instructions can result in severe injury or death.

Observe all safety instructions and precautions when handling automotive batteries, see "Battery" (> page 288).

Never lean over batteries while connecting, you might get injured.

Battery fluid contains sulfuric acid. Do not allow this fluid to come in contact with eyes, skin or clothing. In case it does, immediately flush affected area with water and seek medical help if necessary.

A battery will also produce hydrogen gas, which is flammable and explosive. Keep flames or sparks away from battery, avoid improper connection of jumper cables, smoking, etc.

Practical hints

Battery



Never loosen or detach battery terminal clamps while the engine is running or the SmartKey is in the starter switch. Otherwise the alternator and other electronic components could be severely damaged.

Have the battery checked regularly by an authorized Mercedes-Benz Center.

Refer to Service Booklet for maintenance intervals or contact your authorized Mercedes-Benz Center for further information.

Warning!



Do not place metal objects on the battery as this could result in a short circuit.

Use leak-proof battery only to avoid the risk of acid burns in the event of an accident.

Practical hints

Battery

Disconnecting the battery

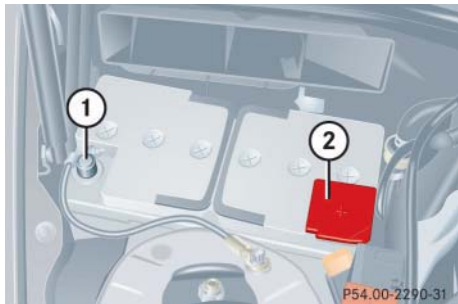

- ① Negative terminal
- ② Positive terminal cover

Warning!



With a disconnected battery

- you will no longer be able to turn the SmartKey in the starter switch and pressing the KEYLESS-GO* start/stop button on the gear selector lever will have no effect
- the gear selector lever will remain locked in position **P**

- ▶ Depress parking brake firmly or move gear selector lever to position **P**.
- ▶ Turn off all electrical consumers.
- ▶ Remove SmartKey from starter switch.
Vehicles with KEYLESS-GO*:
 - ▶ Press the start / stop button until the engine shuts off.
 - ▶ Open the driver's door.
- ▶ Open the hood (▷ page 281).
- ▶ Remove the filter box.
- ▶ Disconnect the battery negative lead.
- ▶ Remove cover ② from the positive terminal.
- ▶ Disconnect the battery positive lead.

Removing the battery

- ▶ Remove the screw securing the battery.
- ▶ Remove the battery support and bracket.
- ▶ Take out the battery.

Charging and reinstalling battery

Warning!



Never charge a battery while still installed in the vehicle. Gases may escape during charging and cause explosions that may result in paint damage, corrosion or personal injury.

- ▶ Charge battery in accordance with the instructions of the battery charger manufacturer.
- ▶ Reinstall the charged battery. Follow the previously described steps in reverse order.

Reconnecting the battery

- ▶ Turn off all electrical consumers.
- ▶ Connect the positive lead and fasten its cover ②.
- ▶ Connect the negative lead ①.



Never invert the terminal connections.

- ▶ Reinstall the filter box (▷ page 363).



The battery, its filler caps and the vent tube must always be securely installed when the vehicle is in operation.



The following procedures must be carried out following any interruption of battery power (e.g. due to reconnecting):

- Set the clock (▷ page 144) (vehicles with COMAND*: see COMAND operator's manual).
- Resynchronize side windows (▷ page 213).
- Resynchronize sliding/pop-up roof* (▷ page 217).

Batteries contain materials that can harm the environment if disposed of improperly. Large 12-volt storage batteries contain lead. Recycling of batteries is the preferred method of disposal. Many states require sellers of batteries to accept old batteries for recycling.

Practical hints

Jump starting

▼ Jump starting

Warning!



Failure to follow these directions will cause damage to the electronic components, and can lead to a battery explosion and severe injury or death.

Never lean over batteries while connecting or jump starting, you might get injured.

Battery fluid contains sulfuric acid. Do not allow this fluid to come in contact with eyes, skin or clothing. In case it does, immediately flush affected area with water, and seek medical help if necessary.

A battery will also produce hydrogen gas, which is flammable and very explosive. Keep flames or sparks away from battery, avoid improper connection of jumper cables, smoking, etc.

Attempting to jump start a frozen battery can result in it exploding, causing personal injury.

Read all instructions before proceeding.

If the battery is discharged, the engine can be started with jumper cables and the battery of another vehicle. Observe the following:

- Jump starting should only be performed when the engine and catalytic converter are cold.
- Do not start the engine if the battery is frozen. Let the battery thaw out first.
- Only jump start from batteries with the same voltage rating (12 V). Jump starting with a more powerful battery could damage the vehicle's electrical system, which will not be covered by the Mercedes-Benz Limited Warranty.
- Only use jumper cables with sufficient cross-section and insulated terminal clamps.
- Always make sure the jumper cables are not on or near pulleys, fans or other parts that move when an engine is started or running.



Avoid repeated and lengthy starting attempts.

Do not attempt to start the engine using a battery quick charge unit.

If the engine does not run after several unsuccessful starting attempts, have it checked at the nearest authorized Mercedes-Benz Center.

Excessive unburned fuel generated by repeated failed starting attempts may damage the catalytic converter and may present a fire risk.

Make sure the jumper cables do not have loose or missing insulation.

Make sure the cable clamps do not touch any other metal part while the other end is still attached to a battery.

Warning!



Keep flames or sparks away from battery.
Do not smoke.

Observe all safety instructions and precautions when handling automotive batteries (▷ page 288).

The battery is located on the right side of the engine compartment. For jump starting use the terminals in front of the battery.

- ▶ Make sure the two vehicles do not touch.
- ▶ Turn off all electrical consumers.
- ▶ Apply parking brake.
- ▶ Shift gear selector lever to position **P**.
- ▶ Open the hood.

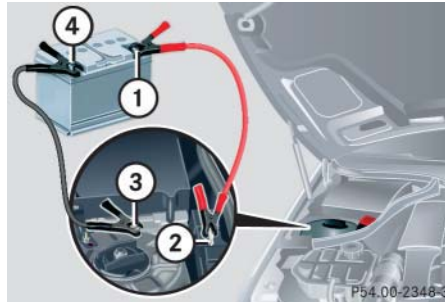

- ① Positive terminal of charged battery
 - ② Positive under hood terminal in front of discharged battery
 - ③ Negative under hood terminal in front of discharged battery
 - ④ Negative terminal of charged battery
- ▶ Connect the positive terminal ① of the charged battery with the positive under hood terminal ② in front of the discharged battery with the jumper cable. Clamp cable to charged battery ① first.



Never invert the terminal connections.

Practical hints

Jump starting

- ▶ Start engine of the vehicle with the charged battery and run at idle speed.
- ▶ Connect the negative terminal ④ of the charged battery with the negative under hood terminal ③ in front of the discharged battery with the jumper cable. Clamp cable to charged battery ④ first.
- ▶ Start the engine of the disabled vehicle.

You can now turn on the electrical consumers. Do not turn on the lights under any circumstances.

- ▶ Remove the jumper cables first from the negative terminals ③ and ④ and then from the positive terminals ① and ②.

You can now turn on the lights.

- ▶ Have the battery checked at the nearest authorized Mercedes-Benz Center.



Do not tow-start the vehicle.

Practical hints

Towing the vehicle

▼ Towing the vehicle

Towing the vehicle

Mercedes-Benz recommends that the vehicle be transported with all wheels off the ground using flatbed or appropriate wheel lift/dolly equipment.



Use flatbed or wheel lift/dolly equipment with SmartKey in starter switch turned to position **0**.

Do not tow with sling-type equipment. Towing with sling-type equipment over bumpy roads will damage radiator and supports.

To prevent damage during transport, do not tie down vehicle by its chassis or suspension parts.

Switch off the tow-away alarm (▷ page 83) and the automatic central locking (▷ page 149).

When circumstances do not permit the recommended towing methods, the vehicle may be towed with all wheels on the ground or front wheels raised only so far as necessary to have the vehicle moved to a safe location where the recommended towing methods can be employed.



If the vehicle is towed with the front axle raised, the engine must be shut off (SmartKey in starter switch position **0** or **1**). Otherwise, the ESP will immediately be engaged and will apply the rear wheel brakes.

When towing the vehicle with all wheels on the ground, the gear selector lever must be in position **N** and the SmartKey must be in starter switch position **2**.

When towing the vehicle with all wheels on the ground or the front axle raised, the vehicle may be towed only for distances up to 30 miles (50 km) and at a speed not to exceed 30 mph (50 km/h).



To be certain to avoid a possibility of damage to the transmission, however, we recommend the drive shaft be disconnected at the rear axle drive flange for any towing beyond a short tow to a nearby garage.

Warning!



Prior to towing the vehicle with all wheels on the ground, make certain that the SmartKey is in starter switch position **2**.

If the SmartKey is left in starter switch position **0** for an extended period of time, it can no longer be turned in the switch. In this case, the steering is locked. To unlock, remove SmartKey from starter switch and reinsert.

If circumstances require towing the vehicle with all wheels on the ground, always tow with a tow bar if:

- the engine will not run
- there is a malfunction in the power supply or in the vehicle's electrical system

as that will be necessary to adequately control the towed vehicle.

Practical hints

Towing the vehicle

Warning!



With the engine not running, there is no power assistance for the brake and steering systems. In this case, it is important to keep in mind that a considerably higher degree of effort is necessary to brake and steer the vehicle. Adapt your driving accordingly.



To signal turns while being towed with the hazard warning flasher in use, turn SmartKey in starter switch to position **2** and activate the combination switch for the left or right turn signal in the usual manner – only the selected turn signal will operate.

Upon canceling the turn signal, the hazard warning flasher will operate again.

Practical hints

Towing the vehicle



When towing the vehicle with all wheels on the ground, please note the following:

With the automatic central locking activated and the SmartKey in starter switch position **2**, or KEYLESS-GO* start/stop button in position **2**, the vehicle doors lock if the left front wheel as well as the right rear wheel are turning at vehicle speeds of approx. 9 mph (15 km/h) or more.

Switch off the tow-away alarm (▷ page 83).

To prevent the vehicle door locks from locking, deactivate the automatic central locking (▷ page 149).

Towing of the vehicle should only be done using the properly installed towing eye bolt. Never attach tow cable, tow rope or tow rod to the vehicle chassis, frame or suspension parts.



The gear selector lever will remain locked in position **P** and the SmartKey will not turn in the starter switch if the battery is disconnected or discharged. See notes on the battery (▷ page 363) or on jump starting (▷ page 366).

Manually unlocking gear selector lever (▷ page 347)

Installing towing eye bolt

Towing eye bolt CLK 320/CLK 500

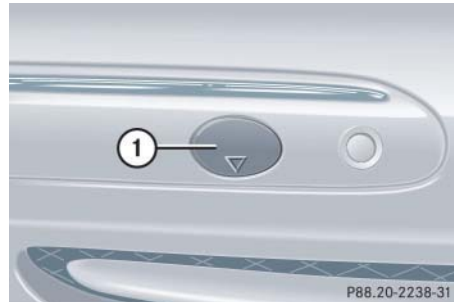

① Cover on right side of front bumper

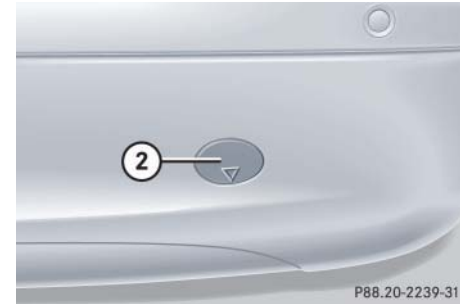

② Cover on right side of rear bumper

To remove cover:

- ▶ Press mark on cover in direction of arrow.
- ▶ Lift cover off to reveal threaded hole for towing eye bolt.

The towing eye bolt is supplied with the tool kit (located in the compartment underneath the trunk floor).

- ▶ Screw towing eye bolt to its stop and tighten with lug wrench.

To reinstall cover:

- ▶ Fit cover and snap into place.

Towing eye bolt CLK 55 AMG

Towing eye bolt in front bumper

The cover for the towing eye bolt in the front bumper is identical to the cover on the models CLK320/CLK500.

To remove and to reinstall cover, see "Towing eye bolt CLK 320/CLK 500" (> page 370)

Towing eye bolt in rear bumper

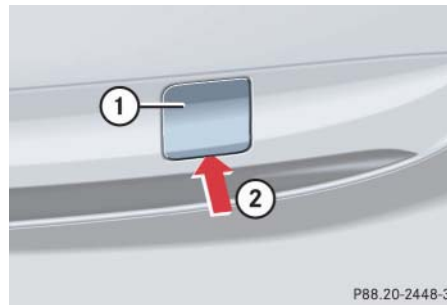

- ① Cover on right side of rear bumper
- ② Recess in the cover

To remove cover:

- ▶ Insert flat, blunt object as a lever in recess ② on the edge of cover ①.
- ▶ Loosen cover ① from the bumper using lever, to reveal threaded hole for towing eye bolt.

The towing eye bolt is supplied with the tool kit (located in the compartment underneath the trunk floor).

- ▶ Screw towing eye bolt to its stop and tighten with lug wrench.

Practical hints

Towing the vehicle

To reinstall cover:

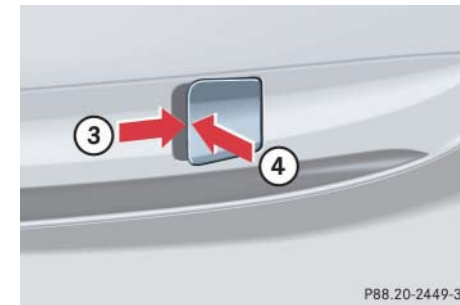

- ▶ Hook right-hand side of the cover into opening.
- ▶ Slide cover as far as it will go in the direction of the arrow ③.
- ▶ Gently press left-hand side of cover in direction of the arrow ④.

The hooks on the left-hand side engage.



When closing the cover, make sure the cover's check strap does not get caught.

Practical hints

Fuses

▼ Fuses



Only install fuses that have been tested and approved by Mercedes-Benz and that have the specified amperage rating.

Never attempt to repair or bridge a blown fuse. Have the cause determined and remedied by an authorized Mercedes-Benz Center.

Fuse box in passenger compartment

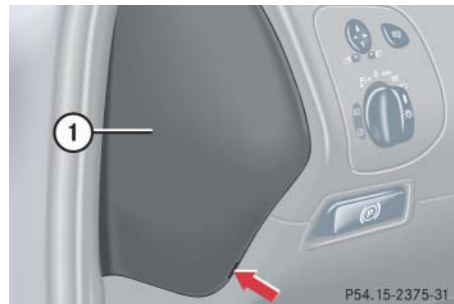

Opening

- ▶ Pull cover away from fuse box ① (arrow).
- ▶ Remove cover rearward.

Closing

- ▶ Attach the cover in the front.
- ▶ Fold the cover in until it engages.

Fuse chart

The fuse chart is found in the fuse box in the passenger compartment. The amperages of the fuses are also given there.

Fuse box in engine compartment

The fuse box is located in the engine compartment on the left-hand side.

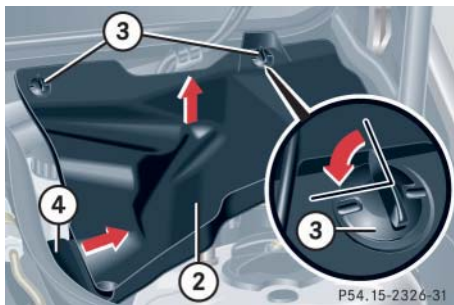

- ② Cover
- ③ Screw
- ④ Retainer

Removing/installing cover

- ▶ Twist screws ③ 90° counterclockwise.
- ▶ Pull up cover ②.
- ▶ Slide out retainer ④ and remove cover by pulling towards front.
- ▶ Install cover ② in reverse order.

Opening fuse box

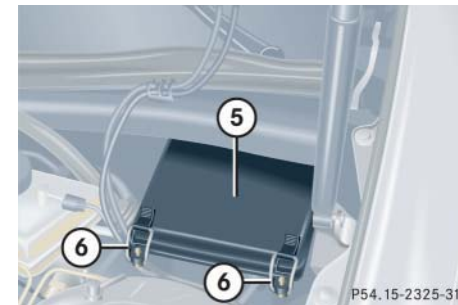

- ⑤ Fuse box cover
- ⑥ Clamps
- ▶ Release clamps ⑥.
- ▶ Remove cover ⑤.

Closing fuse box

- ▶ Ensure that the sealing rubber is properly positioned.
- ▶ Press the cover down and secure with clamps ⑥.

Practical hints

Fuses

Auxiliary fuse box in trunk

The auxiliary fuse box is located in the trunk on the left hand side.

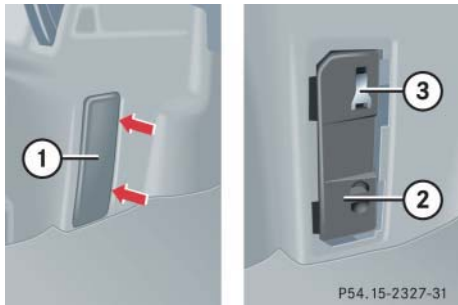

- ① Trim
- ② Cover
- ③ Spare extractor

Opening auxiliary fuse box

- ▶ Pull off trim ①.
- ▶ Remove cover ②.

Closing auxiliary fuse box

- ▶ Place cover ② back on.
- ▶ Press trim ① back into place.

Spare fuses

Spare fuses are found in the vehicle tool kit in the cargo area.

Spare extractor

The fuse extractor is located in the cover of the auxiliary fuse box in the trunk.

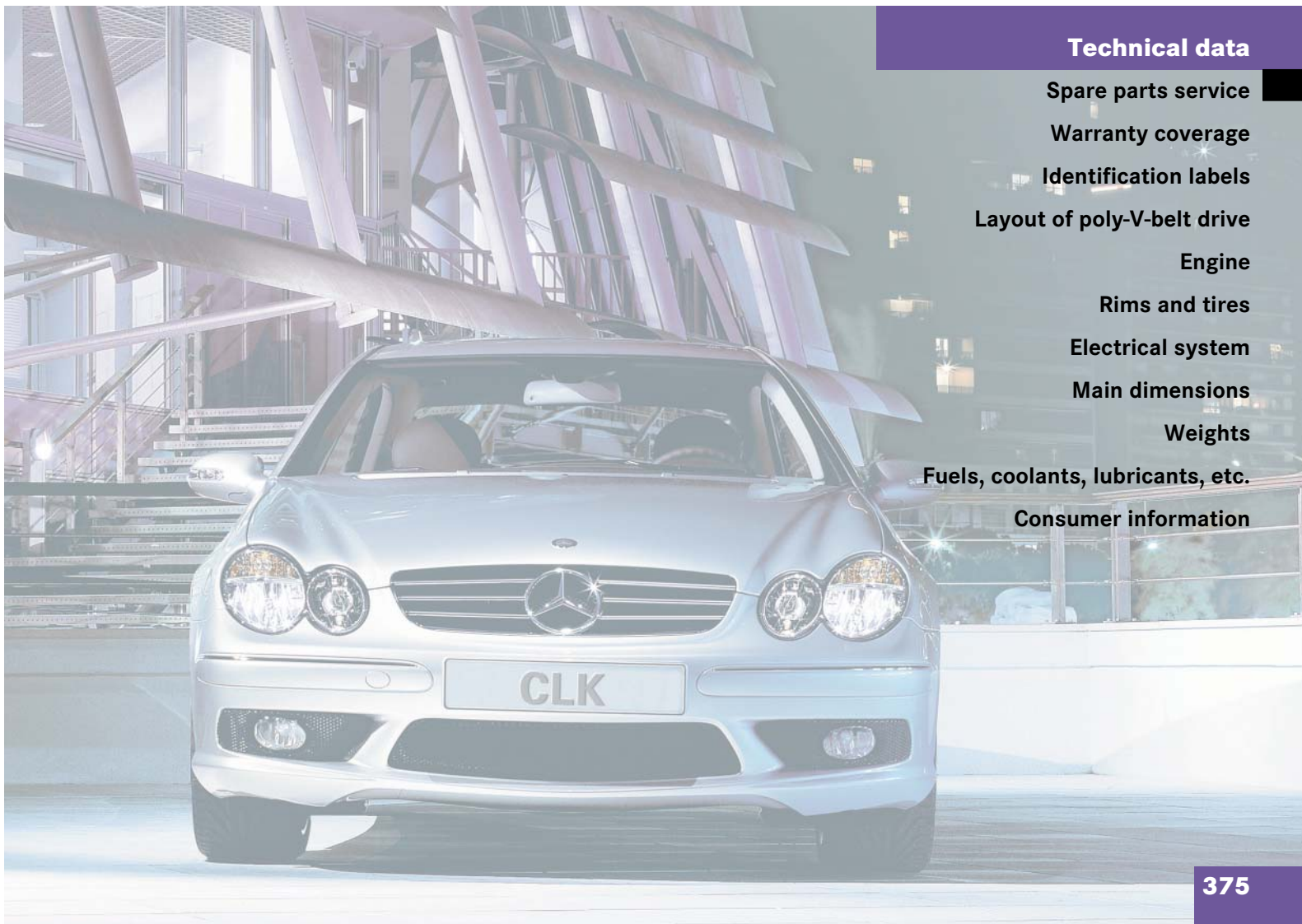

Technical data

Spare parts service

Warranty coverage

Identification labels

Layout of poly-V-belt drive

Engine

Rims and tires

Electrical system

Main dimensions

Weights

Fuels, coolants, lubricants, etc.

Consumer information

Technical data

Spare parts service

The “Technical data” section provides the necessary technical data for your vehicle.

▼ Spare parts service

All authorized Mercedes-Benz Centers maintain a stock of genuine Mercedes-Benz parts required for maintenance and repair work. In addition, strategically located parts distribution centers provide quick and reliable parts service.

More than 300 000 different spare parts for Mercedes-Benz models are available.

Genuine Mercedes-Benz parts are subject to stringent quality inspections. Each part has been specifically developed, manufactured or selected for and adapted to Mercedes-Benz vehicles.

Therefore, genuine Mercedes-Benz parts should be installed.



The use of non-genuine Mercedes-Benz parts and accessories not authorized by Mercedes-Benz could damage the vehicle, which is not covered by the Mercedes-Benz Limited Warranty, or could compromise the vehicle's durability or safety.

▼ **Warranty coverage**

Your vehicle is covered under the terms of the warranties printed in the Service and Warranty Information booklet. Your authorized Mercedes-Benz Center will exchange or repair any defective parts originally installed in the vehicle in accordance with the terms of the following warranties:

- New Vehicle Limited Warranty
- Emission System Warranty
- Emission Performance Warranty
- California, Maine, Massachusetts, and Vermont Emission Control Systems Warranty

Replacement parts and accessories are covered by the Mercedes-Benz Spare Parts and Accessories warranties, copies of which are available at any Mercedes-Benz Center.

Loss of Service and Warranty Information Booklet

Should you lose your Service and Warranty Information booklet, have your authorized Mercedes-Benz Center arrange for a replacement. It will be mailed to you.

Technical data

Identification labels

▼ Identification labels

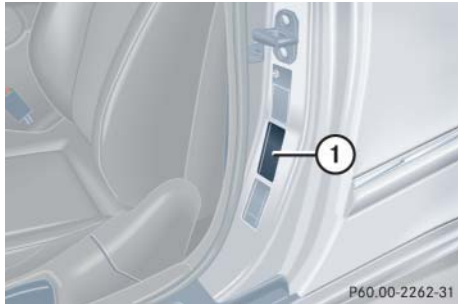

① Certification label

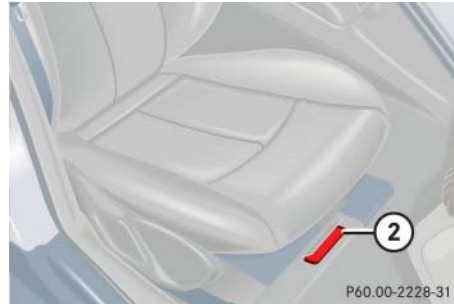

② Vehicle Identification Number (VIN)

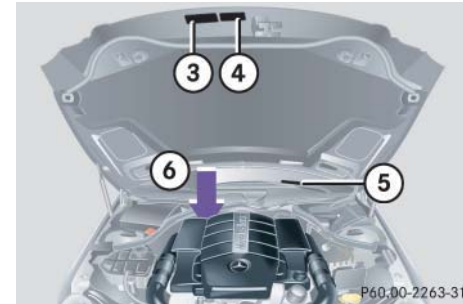

- ③ Information label, California version Vacuum line routing for emission control system
- ④ Emission control label
- ⑤ VIN, visible (lower edge of windshield)
- ⑥ Engine number (engraved on engine)

When ordering spare parts, please specify vehicle identification and engine numbers.

▼ **Layout of poly-V-belt drive**

CLK 320/CLK 500/CLK 55 AMG

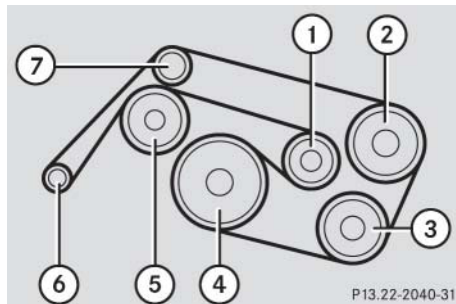

- ① Automatic belt tensioner
- ② Power steering pump
- ③ Air conditioning compressor
- ④ Crankshaft
- ⑤ Coolant pump
- ⑥ Generator (alternator)
- ⑦ Idler pulley

Technical data

Engine

▼ Engine

Model	CLK 320 (209.365) ¹	CLK 500 (209.375) ¹	CLK 55 AMG (209.376) ¹
Engine	112	113	113
Mode of operation	4-stroke engine, gasoline injection	4-stroke engine, gasoline injection	4-stroke engine, gasoline injection
No. of cylinders	6	8	8
Bore	3.54 in (89.90 mm)	3.82 in (97.00 mm)	3.82 in (97.00 mm)
Stroke	3.31 in (84.00 mm)	3.31 in (84.00 mm)	3.60 in (92.00 mm)
Total piston displacement	195.2 cu in (3 199 cm ³)	303.0 cu in (4 966 cm ³)	331.8 cu in (5 439 cm ³)
Compression ratio	10:1	10:1	11:1
Output acc. to SAE J 1349	215 hp / 5 700 rpm (160 kW / 5 700 rpm)	302 hp / 5 600 rpm (225 kW / 5 600 rpm)	362 hp / 5 750 rpm (270 kW / 5 750 rpm)
Maximum torque acc. to SAE J 1349	229 lb-ft / 3 000-4 600 rpm (310 Nm / 3 000-4 600 rpm)	339 lb-ft / 2 700-4 250 rpm (460 Nm / 2 700-4 250 rpm)	376 lb-ft / 4 000 rpm (510 Nm / 4 000 rpm)
Maximum engine speed	6 000 rpm	6 000 rpm	6 700 rpm
Firing order	1-4-3-6-2-5	1-5-4-2-6-3-7-8	1-5-4-2-6-3-7-8
Poly-V-belt	2 380 mm	2 380 mm	2 380 mm

¹ The quoted data apply only to the standard vehicle. See an authorized Mercedes-Benz Center for the corresponding data of all special bodies and special equipment.

▼ Rims and tires

Only use tires and rims which have been specifically developed for your vehicle and tested and approved by Mercedes-Benz. Other tires and rims can have detrimental effects, such as

- poor handling characteristics
- increased noise
- increased fuel consumption



Moreover, tires and rims not approved by Mercedes-Benz may, under load, exhibit dimensional variations and different tire deformation characteristics that could cause them to come into contact with the vehicle body or axle parts. Damage to the tires or the vehicle may be the result.



Further information on tires and rims is available at any authorized Mercedes-Benz Center. A tire inflation pressure table is located on the fuel filler flap of the vehicle. The tire pressure should be checked regularly and should only be adjusted on cold tires. Follow tire manufacturer's maintenance recommendation included with vehicle.

Technical data

Rims and tires

Technical data

Rims and tires

Same size tires

16" tires

	CLK 320	CLK 500 CLK 320 (Appearance Package*)	CLK 55 AMG
Rims (light alloy)	7J x 16 H2	-	-
Wheel offset	1.45 in (37 mm)	-	-
Winter tires (radial-ply tires)	205/55 R16 91H M+S	-	-

17" tires

	CLK 320 CLK 320 (Appearance Package*)	CLK 500	CLK 55 AMG
Rims (light alloy)	7 ¹ / ₂ J x 17 H2	7 ¹ / ₂ J x 17 H2	7 ¹ / ₂ J x 17 H2
Wheel offset	1.42 in (36 mm)	1.45 in (37 mm)	1.45 in (37 mm)
Winter tires (radial-ply tires)	225/45 R 17 91 H M+S ¹	225/45 R 17 91 H M+S ¹	225/45 R17 91 H M+S ¹

¹ Must not be used with snow chains.

Technical data

Rims and tires

Mixed size tires

	CLK 320	CLK 320* CLK 320 (Appearance Package*)	CLK 500 CLK 55 AMG
Front axle:			
Rims (light alloy)	7 J x 16 H2	7 ¹ / ₂ J x 17 H2	7 ¹ / ₂ J x 17 H2
Wheel offset	1.45 in (37 mm)	1.42 in (36 mm)	1.45 in (37 mm)
Summer tires (radial-ply tires)	-	225/45 R17 91W	225/45 R17 91Y
All-season tires (radial-ply tires)	205/55 R16 91H M+S	-	-
Rear axle:			
Rims (light alloy)	8 J x 16 H2	8 ¹ / ₂ J x 17 H2	8 ¹ / ₂ J x 17 H2
Wheel offset	1.26 in (32 mm)	1.18 in (30 mm)	1.18 in (30 mm)
Summer tires (radial-ply tires)	-	245/40 R17 91W ¹	245/40 R17 91Y ¹
All-season tires (radial-ply tires)	225/50 R16 92H M+S ¹	-	-

¹ Must not be used with snow chains.

Technical data

Rims and tires

Minispare wheel

	CLK 320 CLK 320 (Appearance Package*)	CLK 500	CLK 55 AMG
Rim	3.5 B x 16 H2	3.5 B x 17 H2	3.5 B x 17 H2
Wheel offset	0.67 in (17 mm)	0.67 in (17 mm)	0.67 in (17 mm)
Tire	T 125/90 R 16 98M ¹	T 125/80 R 17 99M ¹	T 125/80 R 17 99M ¹

¹ Must not be used with snow chains.

Technical data

Electrical system

▼ Electrical system

Model	CLK 320	CLK 500	CLK 55 AMG
Generator (alternator)	14 V/120 A	14 V/150 A	14 V/150 A
Starter motor	14 V/1.4 KW	14 V/1.7 KW	14 V/1.7 KW
Battery	12 V/100 Ah	12 V/100 Ah	12 V/100 Ah
Spark plugs	Bosch F8 DPP 332 NGK PFR 5R-11	Bosch F8 DPP 332 NGK PFR 5R-11	NGK ILFR 6A
Electrode gap	0.039 in (1.00 mm)	0.039 in (1.00 mm)	0.031 in (0.8 mm)
Tightening torque	18.5 - 22 lb-ft (25 - 30 Nm)	18.5 - 22 lb-ft (25 - 30 Nm)	18.5 - 22 lb-ft (25 - 30 Nm)

Technical data

Main dimensions

▼ Main dimensions

Model	CLK 320	CLK 500	CLK 55 AMG
Overall vehicle length	182.6 in (4638 mm)	182.6 in (4638 mm)	182.6 in (4638 mm)
Overall vehicle width	68.5 in (1740 mm)	68.5 in (1740 mm)	68.5 in (1740 mm)
Overall vehicle height	55.4 in (1406 mm)	55.4 in (1408 mm)	55.4 in (1408 mm)
Wheelbase	106.9 in (2715 mm)	106.9 in (2715 mm)	106.9 in (2715 mm)
Track, front	58.8 in (1493 mm)	58.9 in (1497 mm)	58.9 in (1497 mm)
Track, rear	58.0 in (1474 mm)	58.2 in (1478 mm)	58.2 in (1478 mm)

▼ Weights

Roof load max.	220 lb (100 kg)
Trunk load max.	220 lb (100 kg)

Technical data

Fuels, coolants, lubricants, etc.

▼ Fuels, coolants, lubricants, etc.

Capacities

Vehicle components and their respective lubricants must match. Therefore only use brands tested and approved by Mercedes-Benz.

Please refer to the Factory Approved Service Products pamphlet, or inquire at your Mercedes-Benz Center.

	Model	Capacity	Fuels, coolants, lubricants, etc.
Engine with oil filter	CLK 320	8.5 US qt (8.0 l)	Approved engine oils
	CLK 500	8.0 US qt (7.5 l)	
	CLK 55 AMG	9.0 US qt (8.5 l)	
Automatic transmission	CLK 320	8.0 US qt (7.5 l)	MB Automatic Transmission Oil
	CLK 500	9.3 US qt (8.7 l)	
	CLK 55 AMG	9.3 US qt (8.7 l)	
Rear axle	CLK 320	1.28 US qt (1.2 l)	Hypoid gear oil SAE 85 W 90
	CLK 500	1.5 US qt (1.4 l)	
	CLK 55 AMG	1.5 US qt (1.4 l)	
Power steering		approx. 1.1 US qt (1.0 l)	MB Power Steering Fluid (Pentosin CHF 11S)
Front wheel hubs		approx. 3.0 oz (85 g) each	High temperature roller bearing grease
Brake system		0.64 US qt (0.6 l)	MB Brake Fluid (DOT 4+)

Technical data

Fuels, coolants, lubricants, etc.

	Model	Capacity	Fuels, coolants, lubricants, etc.
Cooling system	CLK 320 CLK 500 CLK 55 AMG	approx. 10.7 US qt (10.0 l) approx. 12.8 US qt (12.0 l) approx. 12.8 US qt (12.0 l)	MB 325.0 Anticorrosion/Antifreeze Agent
Fuel tank including a reserve of		16.35 US gal (62.0 l) 2.11 US gal (8.0 l)	Premium unleaded gasoline: Posted Octane 91 (Avg. of 96 RON / 86 MON)
Air conditioning system			R-134a refrigerant and special PAG lubricant oil (never R-12)
Windshield washer and headlamp cleaning system*		6.4 US qt (6.0 l)	MB Windshield Washer Concentrate ¹

¹ Use MB Windshield Washer Concentrate "S" and water for temperatures above freezing point or MB Windshield Washer Concentrate "S" and commercially available premixed windshield washer solvent / antifreeze for temperatures below freezing point. Follow suggested mixing ratios (▷ page 394).

Technical data

Fuels, coolants, lubricants, etc.

Engine oils

Engine oils are specifically tested for their suitability in our engines. Therefore, only use engine oils approved by Mercedes-Benz. Information on approved engine oils is available in the Factory Approved Service Products pamphlet, or at your authorized Mercedes-Benz Center.



Always check the oil filler cap (> page 285) for important information pertaining to the engine oil needing to meet a specific Mercedes-Benz specification (e.g. MB 229.5). If such information is printed on the oil filler cap, only use an engine oil from the list of approved engine oils in the Factory Approved Service Products pamphlet that meets the specification indicated on the oil filler cap.

Using engine oils of other specification may cause the FSS to incorrectly determine the next service interval and will result in engine damage not covered by the Mercedes-Benz Limited Warranty.

Please follow FSS recommendations for scheduled oil changes. Failure to do so could result in engine damage not covered by the Mercedes-Benz Limited Warranty.

Engine oil additives

Do not blend oil additives with engine oil. They may damage the engine.

Damage or malfunctions resulting from blending oil additives are not covered by the Mercedes-Benz Limited Warranty.

Air conditioning refrigerant

R-134a (HFC) refrigerant and special PAG lubricating oil are used in the air conditioning system.

Never use R-12 (CFC) or mineral-based lubricating oil. Otherwise damage to the system will occur.

Brake fluid

During vehicle operation, the boiling point of the brake fluid is continuously reduced through the absorption of moisture from the atmosphere. Under extremely strenuous operating conditions, this moisture content can lead to the formation of bubbles in the system, thus reducing the system's efficiency.

Therefore, the brake fluid must be replaced every two years, preferably in the spring.

Only brake fluid approved by Mercedes-Benz is recommended. Your authorized Mercedes-Benz Center will provide you with additional information.

Premium unleaded gasoline



To maintain the engine's durability and performance, premium unleaded gasoline must be used. If premium unleaded is not available and low octane fuel is used, follow these precautions:

- Have the fuel tank only partially filled with unleaded regular and fill up with premium unleaded as soon as possible.
- Avoid full throttle driving and abrupt acceleration.
- Do not exceed an engine speed of 3000 rpm if the vehicle is loaded with a light load such as two persons and no luggage.
- Do not exceed $\frac{2}{3}$ of maximum accelerator pedal position if the vehicle is fully loaded or operating in mountainous terrain.

Fuel requirements

Only use premium unleaded gasoline meeting ASTM standard D 439:

- The octane number (posted at the pump) must be 91 min. It is an average of both the Research (R) octane number and the Motor (M) octane number: $(R+M)/2$. This is also known as the ANTI-KNOCK INDEX.

Unleaded gasoline containing oxygenates such as ethanol, IPA, IBA and TBA can be used provided the ratio of any one of these oxygenates to gasoline does not exceed 10%; MTBE not to exceed 15%.

The ratio of methanol to gasoline must not exceed 3% plus additional cosolvents.

Using mixtures of ethanol and methanol is not allowed. Gasohol, which contains 10% ethanol and 90% unleaded gasoline, can be used.

These blends must also meet all other fuel requirements, such as resistance to spark knock, boiling range, vapor pressure, etc.

Gasoline additives

A major concern among engine manufacturers is carbon build-up caused by gasoline. Mercedes-Benz recommends only the use of quality gasoline containing additives that prevent the build-up of carbon deposits.

After an extended period of using fuels without such additives, carbon deposits can build up especially on the intake valves and in the combustion area, leading to engine performance problems such as:

- Warm-up hesitation
- Unstable idle
- Knocking/pinging
- Misfire
- Power loss

Do not blend any specific fuel additives with fuel. This only results in unnecessary cost and may be harmful to the engine operation.

Technical data

Fuels, coolants, lubricants, etc.

Damage or malfunctions resulting from poor fuel quality or from blending specific fuel additives are not covered by the Mercedes-Benz Limited Warranty.

Coolants

The engine coolant is a mixture of water and anticorrosion / antifreeze, which provides:

- Corrosion protection
- Freeze protection
- Boiling protection (by increasing the boiling point)

The cooling system was filled at the factory with a coolant providing freeze protection to approximately -22°F (-30°C) and corrosion protection.

If the antifreeze mixture is effective to -22°F (-30°C), the boiling point of the coolant in the pressurized cooling system is reached at approximately 266°F (130°C).

The coolant solution must be used year round to provide the necessary corrosion protection and increase boil-over protection. Refer to Service Booklet for replacement interval.

Coolant system design and coolant used stipulate the replacement interval. The replacement interval published in the Service Booklet is only applicable if MB 325.0 anticorrosion/antifreeze solution or other Mercedes-Benz approved products of equal specification (see Factory Approved Service Products pamphlet) are used to renew the coolant concentration or bring it back up to the proper level.

To provide important corrosion protection, the solution must be at least 45% anticorrosion/antifreeze (equivalent to freeze protection to approx. -22°F [-30°C]). If you use a solution that is more than 55% anticorrosion/antifreeze (freeze protection to approx. -49°F [-45°C]), the engine temperature will increase due to the lower heat transfer capability of the solution. Therefore, do not use more than this amount of anticorrosion/antifreeze.

If the coolant level is low, water and MB Anticorrosion / Antifreeze should be used to bring it up to the proper level (have cooling system checked for signs of leakage). Please make sure the mixture is in accordance with label instructions.

The water in the cooling system must meet minimum requirements, which are usually satisfied by normal drinking water. If you are not sure about the water quality, consult your authorized Mercedes-Benz Center.

Technical data

Fuels, coolants, lubricants, etc.

Anticorrosion/antifreeze

Your vehicle contains a number of aluminum parts. The use of aluminum components in motor vehicle engines necessitates that anticorrosion/antifreeze coolant used in such engines be specifically formulated to protect the aluminum

parts. (Failure to use such anticorrosion/antifreeze coolant will result in a significantly shortened service life.)

Therefore, the following product is strongly recommended for use in your vehicle: Mercedes-Benz Mercedes-Benz 325.0 Anticorrosion/Antifreeze Agent

Before the start of the winter season (or once a year in hot southern regions), you should have the anticorrosion/antifreeze concentration checked. The coolant is also regularly checked each time you bring your vehicle to your authorized Mercedes-Benz Center for service.

Anticorrosion/antifreeze quantity

Model	Approx. freeze protection	
	-35°F (-37°C)	-49°F (-45°C)
CLK 320	5.3 US qt (5.0 l)	5.9 US qt (5.5 l)
CLK 500	6.4 US qt (6.0 l)	7.0 US qt (6.6 l)
CLK 55 AMG	6.4 US qt (6.0 l)	7.0 US qt (6.6 l)

Technical data

Fuels, coolants, lubricants, etc.

Windshield washer system and headlamp cleaning system*

Both the windshield washer and headlamp cleaning system are supplied from the windshield washer fluid reservoir.

The washer fluid reservoir has a capacity of approx. 6.4 US qt (6.0 l).

- ▶ Refill the reservoir with MB Windshield Washer Concentrate “S” and water (or concentrate and commercially available premixed windshield washer solvent / antifreeze, depending on ambient temperatures).

Warning!



Washer solvent / antifreeze is highly flammable. Do not spill washer solvent / antifreeze on hot engine parts, because it may ignite and burn. You could be seriously burned.

Windshield and headlamp washer fluid mixing ratio

For temperatures above freezing point, use MB Windshield Washer Concentrate “S” and water:

- 1 part “S” to 100 parts water

[40 ml “S” to 1 gallon (4 l) water].

For temperatures below freezing point use MB Windshield Washer Concentrate “S” and commercially available premixed windshield washer solvent / antifreeze:

- 1 part “S” to 100 parts solvent

[40 ml “S” to 1 gallon (4 l) solvent].

▼ Consumer information

The following text is published as required of all manufacturers of passenger cars under Title 49, Code of U.S. Federal Regulations, Part 575 pursuant to the “National Traffic and Motor Vehicle Safety Act of 1966”.

Uniform tire quality grading

Quality grades can be found, where applicable, on the tire sidewall between tread shoulder and maximum section width. For example:

Tread wear	Traction	Temperature
200	AA	A

All passenger car tires must conform to federal safety requirements in addition to these grades.

Tread wear

The tread wear grade is a comparative rating based on the wear rate of the tire when tested under controlled conditions on a specified government test course. For example, a tire graded 150 would wear one and one-half (1½) times as well on the government course as a tire graded 100. The relative performance of tires depends upon the actual conditions of their use, however, and may depart significantly from the norm due to variations in driving habits, service practices and differences in road characteristics and climate.

Technical data

Consumer information

Traction

The traction grades, from highest to lowest are AA, A, B, and C. Those grades represent the tire’s ability to stop on wet pavement as measured under controlled conditions on specified government test surfaces of asphalt and concrete. A tire marked C may have poor traction performance.

Warning!



The traction grade assigned to this tire is based on straight ahead braking traction tests, and does not include acceleration, cornering, hydroplaning, or peak traction characteristics.

Technical data

Consumer information

Temperature

The temperature grades are A (the highest), B, and C, representing the tire's resistance to the generation of heat and its ability to dissipate heat when tested under controlled conditions on a specified indoor laboratory test wheel. Sustained high temperature can cause the material of the tire to degenerate and reduce tire life, and excessive temperature can lead to sudden tire failure. Grade C corresponds to a level of performance which all passenger car tires must meet under the Federal Motor Vehicle Safety Standard No. 109. Grades B and A represent higher levels of performance on the laboratory test wheel than the minimum required by law.

Warning!



The temperature grade for this tire is established for a tire that is properly inflated and not overloaded. Excessive speed, underinflation, or excessive loading, either separately or in combination, can cause excessive heat build-up and possible tire failure.

ABS

(Antilock Brake System)

Prevents the wheels from locking up during braking so that the vehicle can continue to be steered.

Alignment bolt

Metal pin with thread. The centering pin is an aid used when changing a tire to align the wheel with the wheel hub.

BabySmart^{TM1} airbag deactivation system

This system detects if a special system compatible child restraint seat is installed on the front passenger seat. The system will automatically deactivate the passenger front airbag when such a seat is properly installed (indicator lamp PASS. AIRBAG OFF in the center console comes on). See your authorized Mercedes-Benz Center for availability.

BabySmartTM compatible child seats

Special restraint system for children. The sensor system for the passenger seat prevents deployment of the passenger front airbag if a BabySmartTM compatible child seat is installed.

BAS

(Brake Assist System)

System for potentially reducing braking distances in emergency braking situations. The system is activated when it senses an emergency based on how fast the brake is applied.

Bi-Xenon headlamps*

Headlamps which use an electric arc as the light source and produce a more intense light than filament headlamps. Bi-Xenon headlamps produce low beam and high beam.

¹ BabySmartTM is a trademark of Siemens Automotive Corp.

Technical terms

CAC

(Customer Assistance Center)
Mercedes-Benz customer service center, which can help you with any questions about your vehicle and provide assistance in the event of a breakdown.

CAN system

(Controller Area Network)
Data bus network serving to control vehicle functions such as door locking or windshield wiping.

Cockpit

All instruments, switches, buttons and indicator/warning lamps in the passenger compartment needed for vehicle operation and monitoring.

COMAND

(Cockpit Management and Data System)
Information and operating center for vehicle sound and communications systems, including the radio and the navigation system, as well as other optional equipment (CD changer, telephone, etc.).

Control system

The control system is used to call up vehicle information and to change component settings. Information and messages appear in the multifunction display. The driver uses the buttons on the multifunction steering wheel to navigate through the system and to adjust settings.

Cruise control

Driving convenience system for automatically maintaining the vehicle speed set by the driver.

Distronic*

A driving convenience cruise control system which helps the driver maintain a pre-selected speed:

- If there is no vehicle directly ahead, the system operates in the same way as conventional ->cruise control.
- If a slower moving vehicle is ahead, Distronic will reduce your vehicle speed to the extent permitted by reduced throttle and up to 20% braking power to maintain the preset minimum following distance.

Engine number

The number set by the manufacturer and placed on the cylinder block to uniquely identify each engine produced.

Engine oil viscosity

Measurement for the inner friction (viscosity) of the oil at different temperatures. The higher the temperature an oil can tolerate without becoming thin, or the lower the temperature it can tolerate without becoming viscous, the better the viscosity.

ESP

(Electronic Stability Program)
Improves vehicle handling and directional stability.

ETD

(Emergency Tensioning Device)
Device which deploys in certain frontal and rear collisions exceeding the system's threshold to tighten the seat belts.
->SRS

FSS

(Flexible Service System)
Service indicator in the multifunction display that informs the driver when the next vehicle maintenance service is due.

Gear range

Number of gears which are available to the automatic transmission for shifting. The automatic gear shifting process can be adapted to specific operating conditions using the gear selector lever.

GPS

(Global Positioning System)
Satellite-based system for relaying geographic location information to and from vehicles equipped with special receivers. Employs CD digital maps for navigation.

Instrument cluster

The displays and indicator/warning lamps in the driver's field of vision, including the tachometer, speedometer, engine temperature and fuel gauge.

KEYLESS-GO*

System for entering and operating the vehicle without the use of a SmartKey.

Kickdown

Depressing the accelerator past the point of resistance shifts the transmission down to the lowest possible gear. This very quickly accelerates the vehicle and should not be used for normal acceleration needs.

Line of fall

The direct line that an object moves downhill when influenced by the force of gravity alone.

Lock button

Button on the door which indicates whether the door is locked or unlocked. Pushing the lock button down on an individual door from inside will lock that door.

Technical terms

Memory function*

Used to store three individual seat, steering wheel and mirror positions for each SmartKey or, if so equipped, KEYLESS-GO* feature.

Menu

The control system displays are arranged in menus. Each menu contains a number of commands for particular systems. In the Audio menu, for example, you will find the commands *Select radio station* or *Operate CD player*. Using commands, you can directly change the settings for your vehicle.

MON

(Motor Octane Number)

The Motor Octane Number for gasoline as determined by a standardized method. It is an indication of a gasoline's ability to resist undesired detonation (knocking). The average of both the MON (Motor Octane Number) and →RON (Research Octane Number) is posted at the pump, also known as ANTI-KNOCK INDEX.

Multifunction display

Display field in the speedometer used to present information provided by the control system.

Multifunction steering wheel

Steering wheel with buttons for operating the control system.

Overspeed range

Engine speeds within the red marking on the tachometer dial. Avoid this engine speed range, as it may result in serious engine damage that is not covered by the Mercedes-Benz Limited Warranty.

Parktronic (Parking assist)*

System which uses visual and acoustic signals to assist the driver during parking maneuvers.

Poly-V-belt drive

Drives engine-components (alternator, AC compressor, etc.) from the engine.

Power train

Collective term designating all components used to generate and transmit motive power to the drive axles, including

- engine
- clutch/torque converter
- transmission
- transfer case
- drive shaft
- differential
- axle shafts/axles

Program mode selector switch

Used to switch the automatic transmission between regular operation **S** and comfort operation **C**.

CLK 55 AMG with steering wheel gearshift control and manual shift program: In addition to **S** and **C** (for regular **S** or comfort **C** operation, see above) you can use the **M** for manual shift program.

Remote Vehicle Diagnostics

Transmission of vehicle data and current location to the Mercedes-Benz Customer Assistance Center for subscribers to Tele Aid service.

REST

(Residual engine heat utilization)
Feature that uses the engine heat stored in the coolant to heat the vehicle interior for a short time after the engine has been turned off.

Restraint systems

Seat belts, belt tensioners, airbags and child restraint systems. As independent systems, their protective functions complement one another.

RON

(Research Octane Number)
The Research Octane Number for gasoline as determined by a standardized method. It is an indication of a gasoline's ability to resist undesired detonation (knocking). The average of both the →MON (Motor Octane Number) and RON (Research Octane Number) is posted at the pump, also known as ANTI-KNOCK INDEX.

Shift lock

When the vehicle is parked, this lock prevents the gear selector lever from being inadvertently moved out of position **P** without SmartKey turned and brake pedal depressed.

Speedshift (CLK 55 AMG)

Steering wheel gearshift control. You can change the gears yourself with the steering wheel gearshift buttons.

SRS

(Supplemental Restraint System)
Seat belts, emergency tensioning device and airbags. Though independent systems, they are closely interfaced to provide effective occupant protection.

Technical terms

Tele Aid System

(Telematic Alarm Identification on Demand)

The Tele Aid system consists of three types of response: automatic and manual emergency, roadside assistance and information. Tele Aid is initially activated by completing a subscriber agreement and placing an acquaintance call.

The Tele Aid system is operational provided that the vehicle's battery is charged, properly connected, not damaged and cellular and GPS coverage is available.

Telematics*

A combination of the terms "telecommunications" and "informatics".

Tightening torque

Force times lever arm (e.g. a lug wrench) with which threaded fasteners such as wheel bolts are tightened.

Tire speed rating

Part of tire designation; indicates the speed range for which a tire is approved.

Traction

Force exerted by the vehicle on the road via the tires.

VIN

(Vehicle Identification Number)

The number set by the manufacturer and placed on the body to uniquely identify each vehicle produced.

Voice control system*

Voice control system for car phones, portable cell phones and audio systems (radio, CD, etc.).

A

- ABS 23, 76, 397
 - Malfunction indicator lamp 306
 - Messages in display 315
- Accelerator position,
 - automatic transmission 163
- Accident
 - In case of 50
- Activating
 - Air conditioning (cooling) 181
 - Air recirculation mode 178
 - Anti-theft alarm system 82
 - Automatic climate control 173
 - Central locking (control system) 149
 - Charcoal filter 179, 180
 - Distance warning function* 230
 - DISTRONIC* 225, 226
 - Easy-entry/exit feature 150
 - ESP 80
 - Exterior headlamps 47
 - Exterior lamps 120
 - Exterior rear view
 - mirror parking position 168
 - Front and rear fog lamp 121, 122
 - Hazard warning flasher 123
 - Headlamps 47
 - High beams 123
 - Ignition 31
 - Ignition with KEYLESS-GO* 33
 - Immobilizer 53, 81
 - Manual shift program
 - CLK 55 AMG 164
 - Rapid seat heating*
 - with seat ventilation* 115
 - Rapid seat heating*
 - without seat ventilation* 114
 - Rear window defroster 171
 - Residual heat 181
 - Seat heating*
 - with seat ventilation* 115
 - Seat heating*
 - without seat ventilation* 114
 - Seat ventilation* 113
 - Steering wheel gearshift
 - control (CLK 55 AMG) 164
 - Tow-away alarm 83
 - Trunk lid opening limiter*
 - (control system) 149
 - Windshield wipers 49
- Adding
 - Coolant 287
 - Engine oil 285
- Additional turn signals 351
- Adjustable air vents,
 - rear passenger compartment 182
- Adjusting 34
 - Air distribution 176
 - Air volume 177
 - Backrest tilt 36
 - Exterior rear view mirror 39
 - Head restraint height 36
 - Head restraint tilt 36
 - Instrument cluster illumination 126
 - Interior rear view mirror 38
 - Mirrors 38
 - Multicontour seat* 112
 - Seat cushion depth 112
 - Seat cushion tilt 36
 - Seat fore and aft adjustment 35
 - Seat height 36
 - Seats 34
 - Steering column in/out 38
 - Steering column up/down 38
 - Steering wheel 37

Index

- Air conditioning (cooling)
 - Turning off 181
 - Turning on 181
- Air conditioning refrigerant 390
- Air distribution
 - Adjusting 176
- Air pressure see Tire inflation pressure
- Air recirculation mode 178
 - Activating 178
 - Deactivating 179
- Air vents, rear passenger compartment
 - Adjustable 182
- Air volume
 - Adjusting 177
- Airbags 59
 - BabySmart™
 - airbag deactivation system 397
 - Children 60
 - Front 63
 - Passenger 63
 - Safety guidelines 62
 - Side impact 64
 - Window curtain 64
- Alarm
 - Audible 75, 83, 84
 - Canceling 83, 84
 - Visual 82
- Alarm system
 - Anti-theft 82
- Alignment bolt 360
- Alignment bolt (vehicle tool kit) 397
- Anticorrosion/antifreeze 393
- Antiglare
 - Automatic 167
- Antilock brake system (ABS) 397
- Anti-theft alarm system
 - Arming 82
 - Canceling alarm 83, 84
 - Disarming 82
- Anti-theft systems 81
 - Anti-theft alarm system 82
 - Immobilizer 81
 - Tow-away alarm 83
- Aquaplaning see Hydroplaning
- Armrest
 - Storage spaces 246
- Ashtray (Center console) 247
 - Opening 247
 - Reinstalling 248
 - Removing 248
- Ashtray (Rear seat) 248
 - Opening 248
 - Reinstalling 248
 - Removing 248
- At the gas station 278
- ATF (automatic transmission fluid) 286
- AUDIO menu 134
 - Selecting radio station 135
 - Selecting satellite radio* station 135
- Audio system 183
 - Audio and telephone, operation 183
 - Button and soft key operation 186
 - Cassette operation 196
 - CD operation 199
 - Operating and display elements 184
 - Operating safety 183
 - Operation 186
 - Radio operation 189
 - Switching off 186
 - Switching on 186
 - Telephone operation 203

- Automatic antiglare
 - for rear view mirror 167
- Automatic central locking
 - Activating/deactivating (control system) 149
- Automatic climate control 172
 - Adjusting air distribution 176
 - Air recirculation mode 178
 - Defrosting 177
 - Rear window defroster 171
 - Setting the temperature 175
- Automatic headlamp mode 120
- Automatic lighting control
 - Activating 124
 - Deactivating 125
- Automatic locking when driving 105
- Automatic transmission 157
 - Accelerator position 163
 - Comfort (C) program mode 163, 164
 - Emergency operation (Limp Home Mode) 165
 - Fluid level 286
 - Gear ranges 159
 - Gear selector lever position 157, 160
 - Gear shifting malfunctions 165
 - Kickdown 163
 - Manual (M) program mode 164
 - Manual shift program mode (CLK 55 AMG) 164
 - One-touch gearshifting 158
 - Program mode selector switch 163
 - Program mode selector switch CLK 55 AMG 164
 - Speedshift (CLK 55 AMG) 161
 - Sport (S) program mode 163, 164
 - Starting the engine 44
 - Steering wheel gearshift control (CLK 55 AMG) 161
 - Transmission fluid 286
- Auxiliary fuse box 374
- B**
 - BabySmart™
 - Airbag deactivation system 70, 397
 - Compatible child seats 70, 397
 - Self-test 71
 - Backrest
 - Folding forward 241
 - Folding rearward 242
 - Backup lamps 351, 356
 - Bulbs 351
 - BAS 77, 397
 - Messages in display 316
 - Batteries, SmartKey
 - Changing 345
 - Check lamp 87, 92
 - Checking 88, 93
 - Batteries, SmartKey with KEYLESS-GO*
 - Changing 346
 - Check lamp 87, 92
 - Checking 88, 93
 - Battery discharged
 - Jump starting 366

Index

- Battery, vehicle 288, 363
 - Charging 364
 - Disconnecting 364
 - Messages in display 320
 - Reconnecting 365
 - Reinstalling 364
 - Removing 364
- Bi-Xenon headlamps* 397
- Block heater* 295
- Blocking
 - Rear window operation 74
- Bolts
 - For Minispare wheel 342
- Brake assist system (BAS) 397
- Brake fluid 390
 - Message in display 321
- Brake lamp bulbs 351
- Brake lamp, high mounted 351
- Brake pads
 - Message in display 321
- Brakes 268
 - Warning lamp 307
- Break-in period 266
- Bulbs, replacing 350
 - Additional turn signals 351
 - Backup lamps 351
 - Brake lamps 351
 - Fog lamps 351
 - Front lamps 351
 - High beam (Bi-Xenon*) 351
 - High beam (Halogen) 351
 - High beam flasher (Bi-Xenon*) 351
 - High beam flasher (Halogen) 351
 - High mounted brake lamp 351
 - License plate lamps 351, 356
 - Low beam (Bi-Xenon*) 351
 - Low beam (Halogen) 351
 - Parking lamps 351, 353, 355
 - Rear fog lamp 351
 - Rear fog lamps 356
 - Side marker lamps 351, 355
 - Standing lamps 351, 353, 355
 - Tail lamp assemblies 351, 356
 - Turn signal lamps 351
- Button
 - Audio system 186
- C**
 - CAC (Customer Assistance Center) 398
 - Calling up
 - Distronic* settings 137
 - Range (distance to empty) 153
 - Service indicator 297
 - CAN system 398
 - Canceling
 - Cruise control 219
 - Capacities
 - Fuels, coolants, lubricants, etc. 388
 - Cargo tie-down rings 243
 - Cassette operation
 - Playing cassettes 196
 - Cassette player
 - Operating 136
 - Catalytic converter 275
 - CD changer* 199
 - CD operation 199
 - CD player
 - Operating 136

- Center console 25
 - Lower part 26
 - PASS. AIRBAG OFF indicator lamp 313
 - Upper part 25
- Centigrade
 - Setting temperature units 142
- Central locking
 - Automatic 105
 - From inside 106
 - Switch 106
 - Switching on/off (control system) 149
 - Unlocking from inside 106
- Central locking switch 106
- Changing
 - Batteries (SmartKey with KEYLESS-GO*) 346
 - Batteries (SmartKey) 345
 - Key setting 149
- Changing CDs 199
- Charcoal filter 179
 - Activating 179
 - Deactivating 180
- Charging
 - Vehicle battery 364
- CHECK ENGINE malfunction indicator lamp 308
- Checking
 - Coolant level 286
 - Oil level 280, 283
 - Tire inflate pressure 280
 - Vehicle lighting 280
- Child safety 68
 - Airbags 60
 - Infant and child restraint systems 64, 68
 - LATCH child seat anchors 73
- Child safety switch see Blocking of rear window operation
- Child seat anchors see LATCH child seat anchors
- Cigarette lighter 248
- Cleaning
 - Cup holder 303
 - DISTRONIC* system sensor cover 301
 - Gear selector lever 303
 - Hard plastic trim items 303
 - Headlamps 166
 - Headliner 303
 - Instrument cluster 303
 - Leather upholstery 304
 - Light alloy wheels 303
 - Nubuck leather upholstery (CLK 55 AMG) 304
 - Parktronic* system sensor 301
 - Plastic and rubber parts 304
 - Seat belts 303
 - Steering wheel 303
 - Upholstery 304
 - Windows 302
 - Windshield 49
 - Wiper blades 302
 - Wood trims 304
- CLK 55 AMG
 - Manual shift program mode 164
- Clock 23, 144

Index

- Closing
 - Cup holder 245
 - Glove box 244
 - Hood 282
 - Side windows 211
 - Side windows
 - with KEYLESS-GO* 94
 - Sliding/pop-up roof* 214, 348
 - Sliding/pop-up roof*
 - with KEYLESS-GO* 94, 213, 217
 - Sliding/pop-up roof*
 - with SmartKey 216
 - Trunk 97
 - Windows 210
 - Windows
 - with KEYLESS-GO* 213, 217
 - Windows
 - with SmartKey 212
- Closing from the inside
 - Trunk 99
- Closing sliding/pop-up roof*
 - In an emergency 348
- Cockpit 20, 398
- Cockpit management
 - and data system (COMAND*) 398
- COMAND* 398
- COMAND* see
 - separate operating instructions
- Combination switch 123
 - High beam flasher 48, 123
 - Turn signals 48
 - Windshield wipers 48
- Comfort driving
 - Transmission program
 - mode C (Comfort) 163, 164
- Consumer information 395
- Control and operation
 - of radio transmitters 275
- Control system 129, 398
 - AUDIO menu 134
 - Convenience submenu 149
 - Display digital speedometer 134
 - Distronic* menu 137
 - Functions 130, 133
 - Instrument cluster
 - submenu 142, 144
 - Lighting submenu 145
 - Malfunction memory menu 138
 - Menus 132, 133, 400
 - Multifunction display 129
 - Multifunction steering wheel 130
 - NAV menu 137
 - Selecting radio system 135
 - Selecting satellite radio* system 135
 - Settings menu 139
 - Standard display menu 134
 - Submenus 131, 133
 - TEL* menu 154
 - Trip computer menu 152
 - Trunk lid opening limiter* 149
 - Vehicle submenu 148

- Convenience submenu 149
 - Activating
 - easy-entry/exit feature 150
 - Setting key-dependency 151
 - Setting parking position
 - for exterior rear view mirror 151
 - Coolant 286, 392
 - Adding 287
 - Anticorrosion/antifreeze
 - quantity 392
 - Capacities 388
 - Checking level 286
 - Messages in display 322
 - Temperature 277
 - Temperature indicator 127
 - Warning lamp 309, 323
 - Coolant level
 - Checking 286
 - Cruise control 218, 398
 - Canceling 219
 - Driving downhill 219
 - Driving uphill 219
 - Fine adjustment 220
 - Lever 225
 - Messages in display 317
 - Setting current speed 219
 - Setting to last stored speed
 - ("Resume" function) 220
 - Cruise control lever 218
 - Cup holder
 - Cleaning 303
 - Closing 245
 - In rear seat armrest 245
 - In the dashboard 245
 - Opening 245
 - Customer Assistance Center (CAC) 398
- D**
- Daytime running lamp mode 121
 - Setting 145, 146
 - Deactivating
 - Air conditioning (cooling) 181
 - Air recirculation mode 179
 - Alarm 82
 - Anti-theft alarm system 82
 - Automatic climate control 173
 - Central locking (control system) 149
 - Defrosting 177
 - Distance warning function* 230
 - DISTRONIC* 225, 228
 - Engine with KEYLESS-GO* 54
 - Engine with the SmartKey 53
 - ESP 79
 - Exterior lamps 120
 - Hazard warning flasher 124
 - Headlamps 53
 - Immobilizer 81
 - Interior lighting
 - delayed switch-off 148
 - Manual shift programm
 - CLK 55 AMG 165
 - Rapid seat heating*
 - with seat ventilation* 115

Index

- Rapid seat heating*
 - without seat ventilation* 114
- Rear window defroster 171
- Residual heat 182
- Seat heating*
 - with seat ventilation* 115
- Seat heating*
 - without seat ventilation* 114
- Seat ventilation* 113
- Steering wheel gearshift control (CLK 55 AMG) 165
- Tow-away alarm 83, 84
- Trunk lid opening limiter* (control system) 149
- Deceleration
 - With Distronic* 224
- Deep water see Standing water
- Defogging
 - Windshield 176
- Defrosting 177
- Delayed switch-off
 - Interior lighting 148
- Dialing
 - A number (telephone) 155
- Difficulties
 - While driving see Problems while driving
 - With starting 45
- Digital speedometer 134
- Direction of rotation (tires) 291
- Discharged battery
 - Jump starting 366
- Disconnecting
 - Vehicle battery 364
- Display
 - Selecting 143, 144
- Display elements
 - Audio system 184
- Displays
 - Digital speedometer 134
 - Distronic* 223
 - Messages 284, 314
 - Selecting 143
 - Service indicator 296
 - Showing malfunctions 138
- Distance
 - Decreasing in Distronic* 229
 - Increasing in Distronic* 229
 - Setting in Distronic* 228
 - Warning function 229
- Distance to empty (range)
 - Calling up 152
- Distance warning function* 229
 - Activating 230
 - Deactivating 230
 - Distance warning lamp 229
 - Intermittent warning sound 229
 - Symbol in multifunction display 137
- Distronic* 221, 398
 - Activated 225
 - Activating 226
 - Calling up settings 137, 224
 - Cleaning system sensor 301
 - Cruise control lever 225
 - Deactivated 225
 - Deactivating 228
 - Deceleration 224
 - Decreasing distance 229
 - Decreasing time interval 228
 - Displays in the speedometer dial 223
 - Distance warning function 229

Distance warning lamp 310
 Driving hints 230
 Fine adjustment 227
 Increasing distance 229
 Increasing time interval 228
 Intermittent signal tone 223
 Menu 224
 Messages in display 317
 Sensor cover 301
 Setting a higher speed 226
 Setting a lower speed 227
 Setting following distance 228
 Setting the current speed 226
 Setting to last stored speed
 ("Resume" function) 227
 Warning and indicator lamps 223

Door control panel 28
 Door entry lamps 125
 Door handle 28
 Door unlock
 With Tele Aid 258
 Doors
 Message in display 325
 Opening from inside vehicle 95
 Opening from outside 87, 92
 Downhill driving
 Cruise control 219
 Downshifting
 Manual shift program mode
 (CLK 55 AMG) 165
 One-touch gearshifting 158
 Steering wheel gearshift control
 (CLK 55 AMG) 162
 Drinking and driving 267

Driving
 General instructions 40, 267
 Hydroplaning 271
 In winter 273
 Problems 50
 Safety systems 76
 Through standing water 274
 Traveling abroad 274
 With Distronic* 230
 Driving instructions 267
 Driving off 269
 Driving safety systems
 ABS 76
 BAS 77
 ESP 78
 Driving system
 Parktronic* 233
 Driving systems 218
 Cruise control 218
 Distronic* 221
 Driving safety systems 76

Index

E

- Easy-entry/exit feature 107
 - Activating 150
 - Interrupting movement 150
- Electrical fuses 372
- Electrical system
 - Technical data 385
- Electronic Stability Program see ESP
- Emergency call system* 251
- Emergency calls
 - Initiating an emergency call 254
 - Telephone* 208
 - With Tele Aid 252
- Emergency operation (Limp Home Mode) 165
- Emergency operations
 - Closing sliding/pop-up roof* 348
 - Locking the vehicle 344
 - Opening sliding/pop-up roof* 348
 - Remote door unlock 258
 - Unlocking the vehicle 343
- Emergency tensioning device see ETD
- Emission control 276
- Emission control label 378
- Ending
 - A call (telephone) 155
- Engine
 - Compartment 281
 - Message in display 308
 - Starting 44
 - Starting with KEYLESS-GO* 44
 - Starting with the SmartKey 44
 - Technical data 380
 - Turning off 53
- Engine cleaning 300
- Engine compartment 281
 - Fuse box in 373
 - Hood 281
- Engine malfunction indicator lamp 23, 308
- Engine number 399
- Engine oil 283, 390
 - Adding 285
 - Additives 390
 - Checking level 283
 - Consumption 283
 - Filler cap 285
 - Filler neck 285
 - Message in display 326
 - Messages in display 284
 - Viscosity 399
- Engine oil level see Oil level
- ESP 23, 78, 399
 - Messages in display 318
 - Switching off 79
 - Switching on 80
 - Warning lamp 310, 311
- ETD 399
 - Safety guidelines 62
- ETD (Emergency tensioning device) 67
- Exterior lamp switch 119
- Exterior rear view mirrors
 - Adjusting 39
 - Parking position for 151

F

- Fahrenheit
 - Setting temperature units 142
- Fastening the seat belts 40
- Fine adjustment
 - Cruise control 220
 - Distronic* 227
- First aid kit 337
- Flat tire 358
 - Lowering the vehicle 362
 - Minispare wheel 340
 - Mounting the Minispare wheel 358
 - Preparing the vehicle 358
- Flexible Service System (FSS) 296, 399
- Floormates*
 - Installing 249
 - Removing 249
- Floormats* 249
- Fog lamp, rear 122, 351
- Fog lamps
 - Replacing bulbs 351
- Fog lamps, front
 - Messages in display 329
 - Replacing bulbs 352
 - Switching on 122
- Front airbags 63
- Front lamps
 - Messages in display 329–331
 - Replacing bulbs 351, 352
 - Switching on 119
- Front seat head restraints
 - Installing 108
 - Power seat 108
 - Removing 108
- Front seats
 - Heating* 114
 - Ventilation* 113
- FSS (Flexible Service System) 296, 399
- Fuel 279
 - Additives 391
 - Fuel reserve warning lamp 311
 - Gasoline additives 391
 - Premium unleaded
 - gasoline 279, 389, 391
 - Requirements 391
 - Reserve warning 23
 - Technical data 388
- Fuel additives 391
- Fuel consumption statistics
 - After start 152
 - Since last reset 153
- Fuel filler flap 278
 - Locking 278
 - Opening 347
 - Unlocking 278
- Fuel requirements 391
- Fuel reserve tank
 - Message in display 328
- Fuel tank
 - Capacity 389
 - Filler flap 278
- Fuels, coolants, lubricants etc.
 - Capacities 388
- Functions (control system) 130, 133
 - Resetting 140
- Fuse box 372, 373
- Fuse chart 372
- Fuse extractor 374
- Fuses 372
 - Auxiliary fuse box in trunk 374
 - Fuse box in engine compartment 373
 - Fuse box in
 - passenger compartment 372
 - Fuse chart 372
 - Fuse extractor 374
 - Spare fuses 374

Index

G

- Garage door opener 27, 259
- Gasoline see Fuel
 - Gasoline additives 391
- Gear range 399
 - Shifting into optimal 158
- Gear range limit
 - Canceling 158
- Gear ranges 159
 - Displaying in Speedometer 159
 - Limiting 159
- Gear selector lever 23, 347
 - Cleaning 303
 - Lock 44
 - Message in display 319
 - Position 23, 157, 160
 - Unlocking manually 347

Global

- Locking 87
 - Locking with KEYLESS-GO* 92
 - Unlocking 87
 - Unlocking with KEYLESS-GO* 92
- Global Positioning System (GPS) 399
- Glove box 21, 244
 - Closing 244
 - Opening 244
- Good visibility 166
- GPS 399

H

- Hands-free microphone 27
- Hard plastic trim items
 - Cleaning 303
- Hazard warning flasher 123
 - Switching off 124
 - Switching on 123
- Head restraints 108
- Headlamp cleaning system* 289
- Headlamps
 - Automatic control 120
 - Bi-Xenon 397
 - Cleaning 300
 - Cleaning system* 166, 289
 - Refilling washer fluid 289
 - Switching off 53
 - Switching on 47
 - Washer fluid 394
 - Washer system* 394
- Headliner
 - Cleaning 303
- Heated seats* 114
- Height adjustment
 - Head restraints 36

- High beam bulb for high beam flasher (Bi-Xenon*)
 - Replacing bulbs 354
- High beam flasher 48, 123
 - Replacing bulbs (Bi-Xenon*) 351
 - Replacing bulbs (Halogen) 351
- High beam headlamps
 - Messages in display 330
 - Replacing bulbs (Bi-Xenon*) 351
 - Replacing bulbs (Halogen) 351, 353
 - Switching on 123
- High mounted brake lamp 351
- Hood 281
 - Closing 282
 - Message in display 328
 - Opening 281
- Hydroplaning 271
- I**
- Identification labels 378
- Ignition 31, 33
 - Switching on 44
- Immobilizer 81
 - Activating 81
 - Deactivating 81
- Indicator lamps see Lamps, indicator and warning
- Infant and child restraint systems 68
 - Installing 72
 - LATCH child seat anchors 73
- Information
 - About service and warranty 10
 - Button for Tele Aid 256
- Installing
 - Floormates* 249
 - Infant and child restraint systems 72
 - Towing eye bolt 370
 - Towing eye bolt (CLK 55 AMG) 371
 - Wiper blades 357
- Instrument cluster 22, 126, 399
 - Cleaning 303
 - Coolant temperature indicator 127
 - Illumination 126
 - Lamps in 306–312
 - Multifunction display 129
 - Outside temperature indicator 128
 - Selecting language 143
- Instruments and controls see Cockpit
- Interior lighting 124
 - Activating automatic control 124
 - Deactivating automatic control 125
 - Delayed switch-off 148
 - Manual operation 125
- Interior rear view mirror
 - Adjusting 38
 - Antiglare 167
- Interior storage spaces 244
 - Armrest 246
 - Glove box 244
 - Parcel net 247
 - Storage bags 247

Index

J

- Jack 337, 339
- Jump starting 366

K

- Key, mechanical 343
- Key, SmartKey with KEYLESS-GO*
 - Changing the batteries 346
- Key-dependency memory
 - Settings 151
- KEYLESS-GO* 399
 - Activating ignition with 33
 - Closing side windows with 94
 - Closing sliding/pop-up roof*
 - with 94, 213, 217
 - Closing windows with 213, 217
 - Factory setting 92
 - Global locking 92
 - Global unlocking 92
 - Important notes 90
 - Locking the vehicle 93
 - Messages in display 328
 - Remote controls 89
 - Starting the engine 44
 - Turning off the engine 54
 - Unlocking with 32
 - Unlocking, trunk lid 94
- Kickdown 163, 399
- Kilometers/miles in speedometer 142
- Km/h or mph in speedometer 142

L

- Labels, identification 378
- Lamp bulbs, exterior 350
- Lamp sensor
 - Messages in display 330
- Lamps, exterior
 - Front 351
 - Light sensor 330
 - Messages in display 329–332
 - Rear 351
- Lamps, indicator and warning
 - ABS 306
 - Battery (SmartKey) 87, 92
 - Brakes 307
 - Center console 313
 - CHECK ENGINE 308
 - Coolant 309, 322
 - Distance warning 310
 - Distronic* 223, 229
 - Engine diagnostics 308
 - ESP 310, 311

- Fuel reserve 311
- Instrument cluster 306–312
- PASS. AIRBAG OFF 63, 313
- Seat belts 311
- Service indicator 296
- SRS 59, 312
- Turn signals 23
- Language
 - Multifunction display 143
 - Setting 143
- LATCH child seat anchors 73
 - Folding back 73
- Layout of poly-V-belt drive 379
- Leather upholstery
 - Cleaning 304
- Lever
 - For cruise control 225
- License plate lamps
 - Messages in display 330
 - Replacing bulbs 351, 356
- Light alloy wheels
 - Cleaning 303
 - Technical data 382
- Light sensor 330
- Lighter see Cigarette lighter
- Lighting 119
 - Automatic headlamp mode 120
 - Combination switch 123
 - Daytime running lamp mode 121
 - Door entry lamps 125
 - Exterior lamp switch 119
 - Front fog lamps 122
 - High beam flasher 123
 - High beams 123
 - Instrument cluster illumination 126
 - Interior 124
 - Locator lighting 121
 - Low beam 119
 - Manual headlamp mode 120
 - Night security illumination 121
 - Parking lamps 119
 - Rear fog lamp 122
 - Settings (control system) 145
- Limiting the gear range 159
- Limp Home Mode 165
- Line of fall 399
- Loading 237
 - Cargo tie-down rings 243
 - Instructions 242
 - Roof rack 237
 - Ski sack* 237
 - Split rear bench seat 240
- Locator lighting 121
 - Setting 146
- Lock buttons 399
 - Door handle (KEYLESS-GO*) 55
- Locking 51, 86
 - Fuel filler flap 278
 - Global with KEYLESS-GO* 92
 - Global, SmartKey 87
 - The vehicle with KEYLESS-GO* 93
 - Trunk lid, separately 104
 - Vehicle in an emergency 344

Index

- Loss of Service and
 - Warranty Information Booklet 377
- Loss of SmartKey 89
- Loss of SmartKey with KEYLESS-GO* 95
- Low beam headlamps
 - Messages in display 330
 - Replacing bulbs (Bi-Xenon*) 351
 - Replacing bulbs (Halogen) 351, 353
- Lowering
 - Vehicle 362
- Lubricants
 - Technical data 388
- M**
- Main dimensions 386
- Maintenance 12, 296
- Malfunction
 - Displaying 138
- Malfunction memory 138
 - Calling up 138
- Manual gear shifting
 - Transmission program
 - mode M (Manual) 164
- Manual headlamp mode 120
- Manual operations
 - Fuel filler flap 347
 - Interior lighting control 125
 - Locking the vehicle 344
 - Sliding/pop-up roof* 348
 - Unlocking gear selector lever 347
 - Unlocking the driver's door 343
- Manual shift program mode (CLK 55 AMG)
 - Downshifting 165
 - Upshifting 165
- Manual shift programm CLK 55 AMG
 - Activating 164
 - Deactivating 165
- Manual shift programm mode
 - CLK 55 AMG 164
- MAXCOOL maximum cooling 177
- Mechanical key 343
- Memory function 116, 400
 - Recalling positions
 - from memory 117
 - Storing exterior rear view
 - mirror parking positions 118
 - Storing key-dependent settings 117

- Menus 130
 - AUDIO 134
 - Control system 400
 - Distronic* 137, 224
 - In control system 132, 133
 - Malfunction memory 138
 - NAV 137
 - Settings menu 139
 - Standard display 134
 - Submenus 131
 - TEL* 154
 - Trip computer 152
- Microphone
 - Hands-free microphone 27
- Miles/kilometers in speedometer
 - Setting 142
- Minispare wheel 340
 - Mounting 358
 - Removing 340
 - Storing 340
 - Technical data 384
 - Wheel bolts 342
- Mirrors
 - Activating exterior rear
 - view mirror parking position 168
 - Adjusting 38
 - Automatic antiglare
 - for rear view mirror 167
 - Exterior rear view mirror 39
 - Exterior rear view
 - mirror parking positions 151
 - Interior rear view mirror 38
 - Storing exterior rear view
 - mirror parking position 118
- MON 279
- MON (Motor Octane Number) 400
- Mph or km/h in speedometer 142
- Multicontour seat* 112
- Multifunction display 129, 400
 - Selecting language 143
 - Standard display 133
- Multifunction display messages
 - ABS 315
 - BAS 316
 - Battery 320
 - Brake fluid 321
 - Brake pads 321
 - Check engine 308
 - Coolant 323
 - Coolant level 322
 - Cruise control 317
 - Display 325
 - Distronic* 317
 - Doors 325
 - Engine 308
 - Engine oil 326
 - ESP 318
 - Fog lamps, front 329
 - Fuel reserve tank 328
 - Gear selector lever 319
 - High beam headlamps 330
 - Hood 328
 - Key 328
 - Lamp sensor 330
 - Lamps 330

Index

License plate lamp 330
Low beam 330
Parking brake 321
SmartKey with KEYLESS-GO* 328
Steering gear oil level 335
Sunroof* 336
Symbol messages 320–336
Tele Aid 334
Telephone* 336
Text messages 315–319
Trunk 336
Washer fluid 336
Multifunction
steering wheel 24, 130, 400
Buttons 130

N

Navigation system
Operating 137
See separate COMAND*
operating instructions
Night security illumination 121
Nubuck leather upholstery (CLK 55 AMG)
Cleaning 304

O

Occupant safety 58
Airbags 59
Children and airbags 60
Children in the vehicle 68
Fastening the seat belts 40
Infant and child restraint systems 68
LATCH child seat anchors 73
Seat belts 40, 62
Odometer, main 23
Oil
Adding 285
Checking level 283
Consumption 283
Filler cap 285
Filler neck 285
Viscosity 399
Oil level
Checking 280
One-touch gearshifting 158
Canceling gear range limit 158
Downshifting 158
Upshifting 158

Opening

- Ashtray (Center console) 247
- Ashtray (Rear seat) 248
- Cup holder 245
- Doors from the inside 95
- Fuel filler flap 278
- Fuel filler flap manually 347
- Glove box 244
- Hood 281
- Side windows 211
- Sliding/pop-up roof* 214, 348
- Sliding/pop-up roof*
 - in an emergency 348
- Sliding/pop-up roof*
 - with SmartKey 216
- Trunk 96
- Trunk from the inside 97
- Windows 210
- Windows with SmartKey 212

Operating

- Audio system 183
- Cassette player 136
- CD player 136
- COMAND* see separate
 - operating instructions
- Navigation system 137
- Radio 135
- Radio transmitters 275
- Telephone* 154, 183, 203
- Vehicle outside the
 - USA and Canada 13
- Operating safety
 - Audio system 183
- Operator's Manual 10
- Ornamental moldings 300
- Outside temperature indicator 128
- Overdue service 296
- Overhead control panel 27
- Overspeed range 400

P

- Paintwork 299
- Panic alarm 75
 - Panic button on SmartKey 75
- Parcel net in
 - front passenger footwell 247
- Parking 51, 269
- Parking assist* see Parktronic*
- Parking brake 46, 52
 - Engaging 52
 - Message in display 321
 - Releasing 46
- Parking lamps
 - Replacing bulbs 351, 353, 355
 - Switching on 119
- Parking position
 - Exterior rear
 - view mirrors 118, 151, 168
- Parktronic* 233, 400
 - Sensor 301
- Parts see Spare parts service
- PASS. AIRBAG OFF indicator lamp 313

Index

- Passenger compartment 274
 - Fuse box in 372
 - Interior lighting 124
 - Interior rear view mirror 38
 - Parcel net in
 - front passenger footwell 247
 - Storage bags, rear side
 - of the front seats 247
- Passenger safety see Occupant safety
- Pedals 267
- Phone book*
 - Loading 155
 - Quick search 156
- Phone number*
 - Dialing 155
 - Redialing 156
- Plastic and rubber parts
 - Cleaning 304
- Playing
 - CDs 201
- Poly-V-belt drive 400
 - Layout 379
- Positions (Memory function)
 - Recalling from memory 117
 - Storing into memory 117
- Power assistance 267
- Power seat
 - Adjusting backrest tilt 36
 - Adjusting head restraint height 36
 - Adjusting head restraint tilt 36
 - Adjusting seat cushion tilt 36
 - Adjusting seat height 36
 - Front seat head restraints 108
 - Seat fore and aft adjustment 35
- Power train 400
- Power washer 299
- Power windows 210
 - Blocking of rear window operation 74
 - Side windows 210
 - Synchronizing 213
- Practical hints
 - First aid kit 337
 - Fuses 372
 - Lamp in center console 313
 - Lamps in instrument cluster 306
 - Messages in the display 314
 - Minispare wheel 340
 - Minispare wheel bolts 342
 - Towing the vehicle 368
 - Unlocking/locking
 - in an emergency 343
 - Vehicle jack 339
 - Vehicle tool kit 337
- Premium unleaded gasoline 391
- Problems
 - While driving 50
 - With vehicle 17
- Product information 9
- Program mode selector switch 400
 - Automatic transmission 163
 - Automatic transmission, CLK 55
 - AMG 164

Q

Quick search
Phone book* 156

R

Radio
Selecting stations 135
Selecting stations (satellite*) 135
Station search 135
Station selection setting 148
Radio operation 189
Radio see Radio operation
Radio transmitters, control and operation 275
Range (distance to empty)
Calling up 153
Reading lamp 27
Rear bench seat
Foldable 240
Rear fog lamp 351
Bulb 351
Switching on 122
Rear lamp bulbs
Replacing 356
Rear lamps see Tail lamps

Rear passenger compartment
Adjustable air vents 182
Rear seat head restraints
Folding back with release button 109
Folding back with switch 110
Installing 111
Placing upright 110
Rear seats 109
Removing 111
Rear seats
Rear seat head restraints 109
Rear view mirror automatic antiglare 167
Rear view mirrors see Mirrors
Rear window
Blocking operation 74
Rear window defroster 171
Activating 171
Deactivating 171
Rear window sunshade* 170
Reconnecting
Vehicle battery 365
Refrigerant
Air conditioning 390

Refueling 278
Regular checks 280
Reinstalling
Ashtray (Center console) 248
Ashtray (Rear seat) 248
Reinstalling vehicle battery 364
Remote controls
SmartKey 86, 90
SmartKey with KEYLESS-GO* 89
Remote door unlock
With Tele Aid 258
Remote Vehicle Diagnostics 401
Removing
Ashtray (Center console) 248
Ashtray (Rear seat) 248
Floormates* 249
Minispare wheel 340
Ski sack* 240
Vehicle battery 364
Vehicle tool kit 337
Wheel 360
Wiper blades 357

Index

Replacing

- Backup lamp bulbs 356
- Brake lamp bulbs 356
- Bulbs 350
- Front lamp bulbs 352
- Front turn signal bulbs 355
- Front turn signal bulbs (Halogen) 353
- Fuses 374
- High beam bulb for
 - high beam flasher (Bi-Xenon*) 354
- High beam bulbs (Halogen) 353
- License plate lamp bulbs 356
- Low beam bulbs (Halogen) 353
- Parking lamp bulbs 353, 355
- Rear fog lamp bulbs 356
- Rear lamp bulbs 351, 356
- Rear turn signal bulbs 356
- Side marker lamp bulbs 355
- Standing lamp bulbs 353, 355
- Wiper blades 357

Reporting

- Safety defects 18

- Reset button in the instrument cluster 139

Resetting

- All functions (control system) 139
- All functions of a submenu 140
- Fuel consumption 153
- Service indicator (FSS) 297
- Trip odometer 127

- Residual heat utilization 181, 401

- Residual ventilation 181

REST

- (Residual engine heat utilization) 401

Restraint system see

- Infant and child restraint systems 72

- Restraint systems 401

- Rims 381

Roadside Assistance

- Tele Aid 254

- Roadside assistance 12

- RON 279

- RON (Research Octane Number) 401

- Roof rack 237

- Rotating wheels 293

Rubber parts

- Cleaning 304

S

Safety

- Occupant 58

- Safety belts see Seat belts

Safety defects

- Reporting 18

Safety systems

- Driving 76

Searching

- Radio station 135

- Seat belt force limiter 67

Seat belts 64

- Cleaning 303

- Fastening 40

- Proper use of 42, 66

- Safety guidelines 62

- Warning lamp 311

Seat cushion depth

- Adjusting 112

- Seat heating* 114, 115
 - Rapid seat heating switching on/off with seat ventilation* 115
 - Rapid seat heating switching on/off without seat ventilation* 114
 - Switching on/off with seat ventilation* 115
 - Switching on/off without seat ventilation* 114
- Seat ventilation* 113
 - Switching off 113
 - Switching on 113
- Seats 107
 - Adjusting 34
 - Easy entry/exit feature 107
 - Heating* 114
 - Multicontour seat* 112
 - Rapid seat heating* with seat ventilation* 115
 - Rapid seat heating* without seat ventilation* 114
 - Seat heating* 114
 - Seat heating* with seat ventilation* 115
 - Seat ventilation* 113
 - Split rear bench seat 240
- Securing cargo
 - Cargo tie-down rings 243
- Selecting
 - Display 143
- Selecting display 144
- Self-test
 - BabySmart™ airbag deactivation system 71
 - Tele Aid 252
- Service
 - Calling up the service indicator 297
 - Major service (Service B) 296
 - Minor service (Service A) 296
 - Overdue 296
 - Spare parts 376
 - Types 296
 - When due 296
- Service (maintenance) 296
- Service and Warranty Booklet
 - Loss of 377
- Service and warranty information 10
- Service indicator 296
 - Calling up 297
 - Clearing 296, 297
- Service life (tires) 291
- Service System see FSS
- Setting
 - Convenience functions 141, 149
 - Cruise control 219
 - Daytime running lamp mode 145, 146
 - Distronic* time interval 228
 - Following distance in Distronic* 228
 - Higher speed in cruise control 220
 - Higher speed in Distronic* 226
 - Hours (clock) 144
 - Individual vehicle settings 139
 - Interior lighting delayed switch-off 148
 - Key-dependent memory 151
 - Lamps and lighting (control system) 145
 - Language, multifunction display 143
 - Locator lighting 146
 - Lower speed in cruise control 220
 - Lower speed in Distronic* 227
 - Miles/kilometers in speedometer 142
 - Minutes (clock) 145
 - Parking position for exterior rear view mirrors 151
 - Slower speed in cruise control 220

Index

- Speed in Distronic* 226
- Speedometer display mode 142
- Station selection mode 148
- Temperature (interior) 175
- Temperature indicator 142
- To last stored speed
 - ("Resume" function)
 - in cruise control 220
 - To last stored speed
 - ("Resume" function)
 - in Distronic* 227
- Units
 - Speedometer 142
 - Temperature 142
- Setting current speed 219
- Settings
 - Calling up Distronic* 137, 224
 - Convenience functions 149
 - Factory, KEYLESS-GO* 92
 - Factory, SmartKey 87
 - Individual (SmartKey) 151
 - Lighting (control system) 145
 - Menus and submenus 131
 - Resetting all (control system) 139
 - Resetting in the submenu 140
 - Selective 87, 92
- Settings menu
 - Functions in 139
 - Individual vehicle settings 139
 - Submenus 140
- Shift lock 401
- Shifting
 - Gear selector lever positions 160
 - Into optimal gear range 158
- Side impact airbags 64
- Side marker lamps
 - Replacing bulbs 351, 355
- Side windows
 - Automatic opening 211
 - Cleaning 302
 - Closing 210, 211, 212
 - Closing with
 - KEYLESS-GO* 94, 213, 217
 - Closing with SmartKey 212
 - Opening 210, 211, 212
 - Opening fully 211
 - Opening with SmartKey 212
 - Stopping 212
 - Synchronizing power windows 213
- Signal strength (telephone*) 154
- Simultaneous wiping and washing
 - Windshield wipers 49
- Single wipe 49
- Ski sack* 237
 - Removing 240
 - Unfolding and loading 237
 - Unloading and folding 239
- Sliding/pop-up roof
 - Synchronizing 349
- Sliding/pop-up roof* 214
 - Closing 214, 348
 - Closing with
 - KEYLESS-GO* 94, 213, 217
 - Closing with SmartKey 216
 - Opening 214, 348
 - Opening with SmartKey 216
 - Stopping 216
 - Synchronizing 217

SmartKey

- Battery check lamp 87, 92
- Changing the batteries 345
- Checking the batteries 88, 93
- Factory setting 87
- Global locking 87
- Global unlocking 87
- Locking and unlocking 86
- Loss of 89
- Message in display 328
- Opening and closing the
 - sliding/pop-up roof* with 216
- Opening and closing
 - windows with 212
- Positions in starter switch 31
- Remote controls 86, 90
- Restoring to factory setting 87, 92
- Selective setting 87, 92
- Starting the engine 44
- Turning off the engine 53
- Unlocking with 30

SmartKey with KEYLESS-GO*

- Checking the batteries 88, 93
 - Global locking and unlocking 92
 - Locking the vehicle 93
 - Loss of 95
 - Message in display 328
 - Messages in display 328
 - Remote controls 89
 - Restoring to factory setting 87, 92
 - Turning off the engine 54
 - Unlocking with 32
- SmartKeys 86
- Snow chains 295
- Soft keys
 - Audio system 186
- Spare fuses 374
- Spare parts service 376
- Speed
 - Setting current 219
 - Setting to last stored speed ("Resume" function)
 - in Distronic* 227

Speed settings

- Cruise control 220
 - Distronic* 226, 227
 - To last stored speed ("Resume" function)
 - in Cruise control 220
- Speed shift 401
- Speedometer 23
 - Displaying gear range 159
 - Distronic* displays 223
 - Settings units 142
- Speedometer display mode
 - Selecting 142
- Speedshift (CLK 55 AMG) 161
- Split rear bench seat 240
- SRS 66, 401
 - Indicator lamp 312
- Standard driving
 - Transmission program
 - mode S (Sport) 163, 164
- Standing lamps 119
 - Replacing bulbs 351, 353, 355
- Standing water
 - Driving instructions 274

Index

- Starter switch 21, 31
 - Positions 31
- Starting difficulties 45
- Starting position 31
- Starting the engine 43
- Station (radio)
 - Search 135
- Station selection
 - Setting 148
- Steering column
 - In/out adjustment 38
 - Up/down adjustment 38
- Steering gear oil
 - Message in display 335
- Steering wheel 37
 - Adjusting 37
 - Buttons 24
 - Cleaning 303
 - Height adjustment 38
- Steering wheel gearshift control (CLK 55 AMG) 161
 - Activating 164
 - Deactivating 165
 - Downshifting 162
 - Upshifting 162
- Stolen vehicle
 - Tracking services 259
- Stopping
 - Sliding/pop-up roof* 216
 - Windows 212
- Storage bags 247
- Storage compartments
 - Glove box 244
- Storage spaces
 - Cup holder 245
- Storing
 - Minispare wheel 340
- Storing (Memory function)
 - Positions into memory 117
- Submenus
 - Convenience 149
 - For settings 131
 - In control system 133
 - Instrument cluster 142, 144
 - Lighting 145
 - Resetting functions
 - in Control system 140
 - Selecting 140
 - Settings menu 140
 - Vehicle 148
- Sun visors 169
- Sunroof*
 - Message in display 336
- Supplemental Restraint System (SRS) 401
- Switching off
 - Audio system 186
 - Automatic central locking (control system) 149
 - Engine 53
 - ESP 79
 - Hazard warning flasher 124
 - Headlamps 53
 - Rapid seat heating*
 - with seat ventilation* 115
 - Rapid seat heating*
 - without seat ventilation* 114
 - Seat heating*
 - with seat ventilation* 115
 - Seat heating*
 - without seat ventilation* 114
 - Trunk lid opening limiter* (control system) 149

Switching on

- Audio system 186
- Automatic central locking
(control system) 149
- ESP 80
- Front fog lamps 122
- Front lamps 119
- Hazard warning flasher 123
- Headlamps 47
- High beams 123
- Parking lamps 119
- Rapid seat heating*
 - with seat ventilation* 115
- Rapid seat heating*
 - without seat ventilation* 114
- Rear fog lamp 122
- Seat heating*
 - with seat ventilation* 115
- Seat heating*
 - without seat ventilation* 114
- Trunk lid opening limiter*
(control system) 149
- Windshield wipers 48

Symbol (Distronic*)

- Distance warning function* 137

Synchronizing

- Power windows 213
- Sliding/pop-up roof 349
- Sliding/pop-up roof* 217

T

- Tachometer 23, 128
 - Overspeed range 128
- Tail lamps
 - Cleaning 300
 - Replacing bulbs 351, 356
- Tar stains 299
- Technical data 390
 - Brake fluid 390
 - Coolant 388
 - Coolants 392
 - Electrical system 385
 - Engine 380
 - Engine oil 390
 - Engine oil additives 390
 - Fuel requirements 391
 - Fuels 388
 - Gasoline additives 391
 - Lubricants 388
 - Main dimensions 386
 - Premium unleaded gasoline 391
 - Rims and tires 381
 - Weights 387
- Windshield and headlamp
washer* system 389, 394

Index

- Tele Aid 251
 - Emergency calls 252
 - Information 256
 - Initiating an
 - emergency call manually 254
 - Messages in display 334
 - Remote door unlock 258
 - Roadside Assistance 254
 - Stolen vehicle tracking services 259
 - System self-check 252
 - Tele Aid System 251
 - Upgrade signals 257
- Tele Aid System 402
- Telematics* 402
- Telephone* 24, 250
 - Answering a call 155
 - Dialing a number
 - from the phone book 155
 - Emergency call 208
 - Ending a call 155
 - Hands-free microphone 27
 - Loading phone book* 155
 - Messages in display 336
 - Operating 154
 - Operation 203
 - Redialing 156
- Temperature
 - Display mode 142
 - Grades of tires 396
 - Setting interior temperature 175
 - Setting units in display 142
 - Tires 292
- Tie-down rings (Trunk) 243
- Tightening torque 402
- Tightening torque (Wheel bolts) 362
- Time
 - Setting hours 144
 - Setting minutes 145
- Tire inflation pressure
 - Checking 280, 292
- Tire speed rating 272, 402
- Tire traction 271
- Tires 381
 - Consumer information 395
 - Direction of rotation 291
 - Driving instructions 270
 - Retreads 290
 - Rims and tires 381
 - Service life 291
 - Temperature 292
 - Temperature grades 396
 - Tires and wheels 290
 - Tread depth 294
 - Wear pattern 293
 - Winter 294
- Tools 337
- Tow-away alarm 25, 83
 - Arming 83
 - Disarming 83
 - Disarming for transport 83
- Towing eye bolt (vehicle tool kit)
 - CLK 320/CLK 500 370
 - CLK 55 AMG 371
 - Installing 370
 - Installing (CLK 55 AMG) 371
- Towing the vehicle 368

- Tracking services
 - For stolen vehicle 259
 - Traction 163, 395, 402
 - Transmission see Automatic transmission
 - Traveling abroad 274
 - Tread depth (tires) 294
 - Tread wear 395
 - Trip computer 152
 - Trip odometer
 - Resetting 127
 - Trunk
 - Auxiliary fuse box 374
 - Closing 97
 - Closing from the inside 99
 - Lock button, KEYLESS-GO* 93
 - Locking separately 104
 - Message in display 336
 - Opening 96
 - Opening from inside vehicle 97
 - Tie-down rings 243
 - Trunk lid 96, 99
 - Trunk lock 344
 - Unlocking separately 105
 - Unlocking with KEYLESS-GO* 94
 - Unlocking with SmartKey 88
 - Trunk lid emergency release 103
 - Trunk lid opening limiter*
 - Activating/deactivating (control system) 149
 - Trunk lid opening/closing system* 98
 - Opening limiter* (control system) 149
 - Turn signal lamps
 - Replacing bulbs 351
 - Turn signals 48
 - Additional in mirrors 351
 - Cleaning lenses 300
 - Front bulbs 351, 355
 - Front bulbs (Halogen) 353
 - Indicator lamps 23
 - Rear bulbs 351, 356
 - Turning off
 - Engine 53
- U**
- Units
 - Setting speedometer units 142
 - Setting temperature units 142
 - Unlocking 30, 86
 - Driver's door in an emergency 343
 - Fuel filler flap 278
 - Gear selector lever manually 347
 - Global 87
 - Global with KEYLESS-GO* 92
 - In an emergency 343
 - Selective setting 87, 92
 - Trunk lid with KEYLESS-GO* 94
 - Trunk lid with SmartKey 88
 - Trunk lid, separately 105
 - Vehicle in an emergency 258
 - With KEYLESS-GO* 32
 - With the SmartKey 30

Index

- Upgrade signals
 - Tele Aid 257
- Uphill driving
 - Cruise control 219
- Upholstery
 - Cleaning 304
- Upshifting
 - Manual shift program mode (CLK 55 AMG) 165
 - One-touch gearshifting 158
 - Steering wheel gearshift control (CLK 55 AMG) 162
- Useful features 244
 - Ashtray (Center console) 247
 - Ashtray (Rear seat) 248
 - Cigarette lighter 248
 - Floormats* 249
 - Interior storage spaces 244
 - Tele Aid 251
 - Telephone* 250

V

- Vehicle
 - Individual settings 139, 141
 - Locking 25
 - Locking in an emergency 344
 - Lowering 362
 - Service battery 363
 - Towing 368
 - Unlocking 25
 - Unlocking in an emergency 343
- Vehicle battery 363

- Vehicle care 298
 - Cup holder 303
 - Distronic* system sensor cover 301
 - Engine cleaning 300
 - Gear selector lever 303
 - Hard plastic trim items 303
 - Headlamps 300
 - Instrument cluster 303
 - Leather upholstery 304
 - Light alloy wheels 303
 - Nubuck leather upholstery 304
 - Ornamental moldings 300
 - Paintwork 299
 - Parktronic* system sensor 301
 - Plastic and rubber parts 304
 - Power washer 299
 - Seat belts 303
 - Steering wheel 303
 - Tail lamps 300
 - Tar stains 299
 - Turn signals 300
 - Upholstery 304
 - Vehicle washing 300
 - Window cleaning 302
 - Wiper blades 302
 - Wood trims 304

Vehicle jack 339
 Vehicle lighting
 Checking 280
 Vehicle tool kit 337
 Alignment bolt 337
 Removing 337
 Spare fuses 337
 Towing eye bolt 337
 Vehicle jack 337
 Wheel bolts 337
 Wheel wrench 337
 Vehicle washing 300
 VIN (Vehicle Identification Number) 402
 Voice control system* 402
 Hands-free microphone 27

W

Warning sounds
 Distance warning function* 229
 Distronic* 223
 Drivers seat belts 64
 Parking brake 46
 Warranty coverage 377
 Washer fluid see
 Windshield washer fluid
 Washing the vehicle 298
 Wear pattern (tires) 293
 Weights 387
 Wheel bolts
 For Minispare wheel 342
 Wheel change
 Tightening torque 362
 Wheels
 Rotating 293
 Tires and wheels 290
 Window curtain airbags 64
 Windows see Side windows

Windshield

 Defogging 176
 Refilling washer fluid 289
 Replacing wiper blades 357
 Washer fluid 289, 394
 Washer system 394
 Windshield washer fluid 394
 Message in display 336
 Mixing ratio 394
 Refilling 289
 Wiping with 49
 Windshield washer system 394
 Windshield wipers 48, 166
 Fast wiper speed 49
 Intermittent wiping 49
 Replacing wiper blades 357
 Single wipe 49
 Switching on 48
 Wiping with
 windshield washer fluid 49
 Winter driving 294
 Block heater* 295
 Snow chains 295
 Tires 294

Index

Winter driving instructions 273

Winter tires 294

Wiper blades

 Cleaning 302

 Installing 357

 Removing 357

 Replacing 357

Wiping

 And washing simultaneously 49

 Interval 49

 With windshield washer fluid 49

Wood trims

 Cleaning 304

X

Xenon headlamps

 Bi-Xenon 397

Service and Literature

Your authorized Mercedes-Benz Center has trained technicians and original Mercedes-Benz parts to service your vehicle properly. For expert advice and quality service, see your authorized Mercedes-Benz Center.

If you are interested in obtaining service literature for your vehicle, please contact your authorized Mercedes-Benz Center. We consider this the best way for you to obtain accurate information for your vehicle.

For further information you can find us on the Mercedes-Benz web-site www.mbusa.com or www.mercedes-benz.ca.

Warning!



To help avoid personal injury, be extremely careful when performing any service work or repairs. Improper or incomplete service or the use of incorrect or inappropriate parts or materials may damage the vehicle or its equipment, which may in turn result in personal injury.

If you have questions about carrying out any type of service, turn to the advice of an authorized Mercedes-Benz Center.

We reserve the right to modify the technical details of the vehicle as given in the data and illustrations of this Operator's Manual. Re-printing, translation and copying, even of excerpts, is not permitted without our prior authorization in writing.

Title illustration no. P00.01-2353-31

Date to press 08 / 14 / 03

GSP / TIP

Printed in Germany

